



Oil & Gas Ltd

Suite 1800 Eighth Avenue Place, 525 – 8th Avenue SW, Calgary, AB T2P 1G1 | p. 403.930.4120 | f. 403.930.4159

Proposed East Manson Unit No.6

Application for Waterflood EOR

Manson, Manitoba

June 15, 2015

Table of Contents

Introduction.....	1
Summary.....	2
Geological Discussion	3
Reservoir Characteristics and Current Recovery	5
Original Oil in Place	5
Reservoir and Fluid Properties	5
Historical Production	5
Primary Depletion	6
Unitization	7
Waterflood Project Development.....	8
Proposed Water Injection Well Conversions and Timing	8
Waterflood Operating Strategy	9
Technical Studies	9
Secondary Recovery and Production Forecast	10
Appendix A: Unit & Notification	11
Appendix B: Geological Maps	15
Appendix C: Reservoir Characteristics & Recovery	28
Appendix D: Proposed Waterflood Design	35
Appendix E: EMU No.1 Waterflood Response	40

Introduction

In accordance to Section 71 of the Drilling and Production Regulations of Manitoba, TORC Oil & Gas Ltd (TORC) is requesting the board's approval of a newly proposed East Manson Unit No.6 (EMU No.6). The unit will be located in the West half and Southeast quarter of Sections 28-13-28W1 with the intent of further extending a waterflood in the Bakken pool.

Since the first vertical discovery well in August 2010, a total of 45 horizontal and 15 vertical wells have been drilled targeting the Middle Bakken in the Manson area. The large Middle Bakken pool trends southeast to northwest from section 3-13-28W1 to section 14-14-29W1 respectively. A low pool-wide estimated ultimate recovery (EUR) of 7.2% is expected due to negligible solution gas and low initial pressure. The proposed waterflood and unit area will further expand the waterflood.

The proposed EMU#6 waterflood area is currently developed with 1 vertical and 3 horizontal wells. Following approval of the proposed unit, 3 new horizontals will be drilled and 2 existing wells will be converted to injectors in order to complete the waterflood scheme outlined in *Appendix D, figure 3*. Results to date from offsetting Manson waterflood units and developed waterflood areas in analogous Bakken / Three Forks reservoirs in the Daly and Sinclair areas demonstrate that incremental recovery factors of over 13% can be attained.

If you have any questions or concerns about the application, please contact the undersigned.

Sincerely,

Kristine Michie, P.Eng
Engineering Manager, Saskatchewan
TORC Oil & Gas Ltd
ph (403) 930-4120
kmichie@torcoil.com

Summary

1. The Proposed East Manson Unit No.6 will include 12 legal subdivisions (LSD's) in Section 28-13-28W1, where 1 vertical and 3 horizontal wells are completed in the Middle Bakken formation. A map of EMU No.6 is attached in *Appendix A, figure 1*.
2. *Appendix C, figures 2 & 3* show oil production from the proposed East Manson Unit No.6 of 2.16 m³/d and an average water cut of 64.1% as of February 28, 2015.
3. Original oil in place (OOIP) for the proposed unit is 790 e³m³ or 65.8 e³m³/ LSD. (see *Appendix C, figure 1*)
4. Cumulative oil production from the proposed unit as of February 28, 2015 is 6.5 e³m³, giving a current recovery factor (RF) of 0.8% within the unit boundary.
5. Declines for the 3 current producing wells show an estimated ultimate recovery (EUR) of 9.7 e³m³ and remaining recoverable oil in place as of February 28, 2015 of 3.2 e³m³. This gives an ultimate recovery factor of 1.2% under primary depletion.
6. Initial reservoir pressure (Pi) of the Middle Bakken reservoir was 5500 kPa. This value was consistent with four different static gradients taken in SEC 12 TWP 14 RNG 29 and 20, 29, 28 TWP 13 RNG 28W1. Current reservoir pressure (Pr) is estimated to be approximately 2000 kPa based on recent Pressures and Fluid Levels taken on 02/01-28 and 00/11-28-013-28W1.
7. The existing Daly Bakken A water flood in SEC 21, 28 and 29 TWP 10 RNG 29W1 can be used as an analogy with similar geology and reservoir characteristics where an 8% incremental waterflood recovery factor has been seen. TORC believes that favorable results can be achieved in EMU No.6 utilizing a horizontal injection pattern. Results from offsetting units under waterflood also show good waterflood response with a minimal response period. Post flood ultimate recovery of approximately 6.2% is forecasted for the S ½ and NW ¼ of Sec 28 (*Appendix C, Figure 4*).
8. Upon approval, 1 horizontal well will immediately be converted to injection, and 1 vertical will be converted to injection in the future once TORC drills wells offsetting it. A fully developed injection pattern is shown *Appendix D, figure 3*, with a target water injection date of September 15, 2015.

Geological Discussion

Stratigraphy

The stratigraphy in EMU No. 6 is defined by the cross section A-A` seen in *Appendix B, figures 11 & 12*. Cross section A-A` can be observed on each of the Appendix B maps running from the Northwest to the Southeast. The section consists of the Upper Bakken Shale, the Middle Bakken Carbonaceous Siltstone, a thin, sometimes almost absent, reddish-brown shale, the Torquay Dolomitic Siltstone and the laminated shaly siltstone of the Torquay (Three Forks) Unit 2. The Torquay (Three Forks) Unit 2 siltstone is an oxidized, reddish brown – greenish grey laminated shaly siltstone with little to no reservoir quality. The Torquay unit is a light reddish grey dolomitic siltstone with good intergranular porosity. The Torquay unit is unconformably overlain by the Middle Bakken Siltstone which represents the main reservoir unit. The Upper Bakken Shale is a black, organic rich and platy shale that conformably overlies the Middle Bakken Siltstone to form the upper seal for the main Middle Bakken reservoir.

Reservoir Sedimentology

The Middle Bakken reservoir is composed of coarse grained siltstone to fine grained sandstone which can be subdivided into the upper, middle, and lower units.

The upper unit is generally a bioturbated, pale grey, medium to coarse silt. Although containing varying traces, the bioturbated beds are often represented by possible teichichnus and planolites with thin walled brachiopod shells occurring near the top of bedding surfaces. The upper unit was likely deposited in an offshore marine environment and is considered a non-reservoir unit in the majority of cases. The middle unit is generally an interlaminated, tan to grey, coarse silt to very fine sand and shale. There is an obvious lack of bioturbation in this unit indicating a restrictive environment. Overall, this unit contains multiple fining upwards successions that are dominated by coarse silt to very fine sand deposition near the base. This grades into interlaminated silts and shales near the top of each succession. Although the middle unit contains variability, it is considered a reservoir unit ranging from 0.5 to 1.5 meters thick. It is likely this unit represents a transitional stage between offshore marine and coastal environments.

The lower unit is generally a moderately to well sorted, tannish grey, coarse silt to fine sand with abundant ripple cross laminations. Occasional trough cross bedding and potential rip up clasts near the base indicates a higher energy influence. Lower unit thickness can vary, however it is generally between 2 and 4 meters thick and represents the main reservoir. This unit was likely deposited in a shoreface environment.

Structure

Structure maps for the Upper Bakken, Middle Bakken, Torquay (erosional unconformity of Middle Bakken) and Unit 2 can be seen in *Appendix B, Figures 1 to 4*. The general structure in the area of the Bakken and Torquay (Three Forks) consists of a gentle dip to the southwest. Slight variations in the regional dip can be seen in the northeast corner of section 28 and the southwest corner of section 32.

This is likely the result of dissolution of the underlying prairie evaporites. It is important to note that while these localized variations are present, they do not represent barriers to lateral fluid flow within the reservoir. This can be seen in cross section A-A', where lateral continuity of the reservoir beds is present (*Appendix B, Figures 11 & 12*).

Reservoir Continuity

The cross section A-A' and isopach, seen in *Appendix B, figures 10 & 5*, confirm there is no significant thinning of the reservoir units in the Middle Bakken within SEC 28-13-28W1. An on-lap edge can however be seen northeast of the area resulting in a pinching of the main reservoir unit. Described briefly in stratigraphy, the Torquay Siltstone is generally separated from the main Middle Bakken reservoir by a thin shale unit which can act as a bit of a pressure boundary between the two reservoirs. Although the Torquay Siltstone is not the main target, it has shown to be productive with the aid of hydraulic fracture stimulation and in penetrating horizontal well paths.

Reservoir Quality

To examine reservoir quality, porosity ($\phi_h - \text{por}^*m$) and permeability ($k_h - \text{mD}^*m$) maps for the main reservoir units are provided in *Appendix B, figures 7 & 8*. With only 12 cores in the map area, porosity-permeability cross plots were created to help with the prediction of values for wells that were not cored. (*Appendix B, figure 10*) This core data was then subjected to a 1 mD permeability cut-off and the intervals greater than or equal to the criteria were multiplied by interval thickness to obtain ϕ_h and k_h values. A 1 mD permeability cut-off roughly correlates to a 18% porosity cut-off. It is important to note that a permeability cut-off was applied under the concept that contribution from intervals with permeabilities less than 1 mD will be limited. It is likely that there will be contribution from pore volume with less than 1mD of permeability; however the extent of contribution could prove difficult to predict and potentially result in unrealistic ϕ_h and k_h values. It is recommended the cut-off not be taken in the strictest sense and the absolute potential of the reservoir should still be explored.

Fluid Contacts

The oil-water contact of the Middle Bakken Reservoir has been interpreted from logs to be at approximately -192m subsea. Based on the structural mapping done, the contact is located too far down dip to appear on any of the EMU No. 6 maps, as the lowest structural elevation for the top of the Middle Bakken is approximately -156m subsea. Fluid contacts pose no risk to this reservoir.

Reservoir Characteristics and Current Recovery

Original Oil in Place

Porosity and water saturation values were taken from a combination of neutron- density logs and core samples where stratigraphic test holes are present. Petrophysical data such as open-hole logs and core analyses can be submitted upon request. Volumetric original oil in place (OOIP) was calculated for the proposed waterflood area using a combined beach (lower unit) and marl (upper unit) $\phi \cdot h$ map. $\phi \cdot h$ and an average initial S_w of 23.0% over the S ½ and NW ¼ of SEC 28 equated to an OOIP of 790 e3m3. OOIP per LSD can be seen in *Appendix C, figure 1*.

Reservoir and Fluid Properties

Applicable reservoir and fluid properties are outlined in the following table. All information supporting the following values such as fluid analyses and static gradients can be submitted upon request.

Torquay Reservoir and Fluid Properties		
<u>Reservoir:</u>		<u>Comments</u>
Initial Reservoir Pressure (Pi)	5.5 MPa	From static Gradient
Current Reservoir Pressure (Pr)	2.0 MPa	August 2013 build-up
Formation Breakdown Pressure (Pfrac)	14 MPa	Average from fracs
Average Water Saturation (Sw)	0.23	From Core Samples
Core Wettability	Moderate water wet	From 15-20 Rel perms
<u>Fluid:</u>		
Oil API Gravity @ 15 C	35.3	From 11-12 Oil analysis
Total Sulphur Mass Fraction	0.00315	From 11-12 Oil analysis
Absolute Viscosity @ 25 C (cP)	6.21	From 11-12 Oil analysis
Formation Water Salinity (ppm)	22,000	8-21 water analysis
Formation Water Resistivity @ 25 C	0.312 Ohm*m	8-21 water analysis

Historical Production

Section 28-13-28W1 has been developed with 1 vertical, and 3 East-West horizontal wells. Spacing between horizontal wells varies between 150m and 200m as seen in *Appendix A, figure 1*. To date, 6.5 e3m3 of oil has been recovered from Section 28 with production beginning in November 2011 and peaking in March 2012 at 15.2 m3/d oil and 43.1 m3/d water. A daily rate group plot showing historical production can be seen in *Appendix C, figure 2*.

Primary Depletion

Estimated ultimate oil recovery (EUR) for SEC 28 is 9.7 e3m3 using decline analysis on individual wells and a 0.32 m3/d per well economic cut-off. Three additional horizontal wells are planned within the unit boundary and are forecasted to spud as per below:

UWI	Estimated Spud date
(8-29) 102/08-28-13-28W1 HZ	October 2017
(9-29) 102/11-28-13-28W1 HZ	October 2019
(9-29) 100/14-28-13-28W1 HZ	October 2019

A group plot of declines for all Sec 28-13-28W1 wells can be seen in *Appendix C, figure 4*, where horizontal wells have fitted to a hyperbolic decline with a hyperbolic exponent b of 0.5. An average yearly decline of 20% is expected in middle and later production periods.

No extensive PVT analysis has yet been conducted on reservoir fluids. Surface gas to oil ratio (GOR) has been measured to be between 2 and 5 m3/m3. It is believed that due to the low GOR, all gas can be considered solution gas. Current reservoir pressure conditions are expected to be undersaturated or near bubble point where reservoir drive is largely limited to fluid and rock expansion.

This was demonstrated with the pilot SEC 29 waterflood, where response was seen in approximately 15 days in producers 200m from a pilot injector. Rapid response is seen primarily due low reservoir gas saturation. This dictates fluid volume considered for the voidage replacement ratio (VRR) seen in the 'Waterflood Operating Strategy' portion of this application.

Unitization

Unit name: TORC Oil & Gas Ltd proposes that the name of the new unit will be East Manson Unit No.6 (EMU No.6).

Unit Operator: TORC Oil & Gas Ltd will assume operatorship of East Manson Unit No.6.

Unitized Zone(s): The proposed unitized zones will be the Bakken and Torquay (Three Forks) formations.

Unit Lands: LSDs 1 to 8, and 11 to 14 of SEC 28-13-28 west of the prime meridian will be included in the proposed Manson Unit No.6.

Unitized wells: East Manson Unit No.6 will consist of 2 injectors and 5 producing wells. One of the proposed injectors (102/01-28-013-28W1/00) will be immediately converted upon approval of the unit and according to the proposed development plan outlined in *Appendix D, figure 3*. The 100/11-28-013-28W1/00 well will be converted to injection once offsetting horizontal producers are drilled. Following is a list of wells within the unit area:

License #	UWI	Proposed Status
8422	(01-29) 100/01-28-013-28W1 HZ	Producer
9146	(02-29) 102/01-28-013-28W1 HZ	Injector (conversion)
8181	(08-29) 100/05-28-013-28W1 HZ	Abandoned Strat Test Hole
8455	(08-29) 100/08-28-013-28W1 HZ	Producer
TBA	(08-29) 102/08-28-013-28W1 HZ	Producer (new drill)
7500	(11-28) 100/11-28-013-28W1 VT	Injector (conversion)
TBA	(09-29) 102/11-28-013-28W1 HZ	Producer (new drill)
TBA	(09-29) 100/14-28-013-28W1 HZ	Producer (new drill)

Working interest and mineral owners: TORC Oil & Gas Ltd is currently the 100% working interest holder in LSDs 1 to 8, and 11 to 14 of SEC 28-13-28 and will be the single working interest holder in the East Manson Unit No.6. Mineral lessors are outlined below:

LSD's 1 to 8, & 11 to 14 SEC 28 TWP 13 RGE 28 W1M: 100% CROWN

Tract Factors: Because all lands in the Unit Area of Application are 100% Crown Lessor and 100% SGY Lessee, it is not required to calculate tract factors for EMU No.6.

Waterflood Project Development

Proposed Water Injection Well Conversions and Timing

TORC proposes to convert a total of 1 horizontal well to a Middle Bakken Injector with injection set for Q3 of 2015 or upon the board's approval. A typical injector well schematic can be seen in *Appendix D, figure 1*.

Total daily injection demand for EMU#6 is expected to be approximately 90 m³/d, as outlined in the following table. Source water injection demand for EMU #1, 3, 4, and 6 will be met from the following sources:

- existing pool-wide Manson production
- the 15-30-13-28W1 Jurassic source well

An extensive study has been conducted by J.N. Fox & C.D. Martiniuk (1994) from Manitoba Energy and Mines on analogous Middle Bakken pools and waterfloods in the Daly area. Fox and Martiniuk outline waterflood compatibility and sensitivity studies indicate that produced water from the Lodgepole and Jurassic source water were compatible with Bakken formation fluids and would not cause clay swelling problems.

Produced injection water will be treated, separated at the TORC 13-29-13-28W1 battery then filtered and pumped to the proposed injection wells. Fiber reinforced polyethylene lines will be utilized for injection. A flow diagram of the proposed injection system and addition to the current 13-29-13-28W1 battery can be seen in *Appendix D, figure 2*. Corrosion mitigation measures will also be implemented throughout the duration of the proposed water flood and are outlined in *Appendix D, figure 4*. A schedule of injectors and anticipated injection rates can be seen below:

License #	UWI	Conversion Timing	Anticipated Initial Injection Rate
9146	(02-29) 102/01-28-013-28W1 HZ	September 2015	60 m ³ /d
7500	(11-28) 100/11-28-013-28W1 VT	July 2019	30 m ³ /d

Anticipated injection rates are based on historical fluid production for each well and will vary according to the following injection parameters:

Formation Fracture Pressure	14 MPa
Formation Fracture Wellhead Pressure	7.5 MPa
Requested Maximum Wellhead Pressure (90% of above)	6.8 MPa

Formation fracture pressure was determined from extensive hydraulic fracture data throughout sections 20, 21 and the Manson field. TORC requests a maximum injection pressure of 90% of the Formation Fracture Wellhead pressure = 6.8 MPa.

Waterflood Operating Strategy

The first injector conversion is proposed to occur in September 2015. A fill-up period of approximately 1 month is expected due to negligible gas saturation (S_g), and has been seen in the SEC 29 pilot. Target reservoir pressure will be 5.5 MPa, while maintaining a voidage replacement ratio (VRR) between 1 and 1.3. Some out of zone thieving to the Lower Lodgepole is expected as some natural fractures are believed to have reached porosity in the Lodgepole. Voidage replacement will be monitored and modeled throughout the injection process to maximize reserve recovery.

The following surveillance data and calculations will be acquired throughout the duration of the SEC 28 flood:

- Short-term pressure build-ups on both producers and injectors to monitor reservoir pressure.
- Wellhead flow meters on all wells to acquire daily rates
- Continuous wellhead injection pressure monitoring
- Weekly water cuts on all wells
- The use of fractional flow and Hall plots
- Analysis of acquired data and observation of trends in: water oil ratio (WOR), reservoir pressure (Pr), production rate, injection rate, cumulative production, etc.

In accordance to Section 73 of the Drilling and Production Regulations, an annual EOR report outlining the above data and calculations will be submitted within 60 days of initial injection and within 60 days after the end of each calendar year.

Technical Studies

Listed below are several technical studies have been carried out with respect to the Manson Bakken waterflood project.

Core Analyses:

- 24 cores taken throughout the Manson field
- 4 cores within or adjacent to EMU No.4

Special Core Analysis (SCAL):

- Performed on 2 Middle Bakken core plugs from the 15-20-13-28W1 vertical well
- Relative permeability indicates that the core is water wet
- Calculated mobility ratio (M) of 0.7 with an oil viscosity of 2.48 cp
- Calculated response time of 10 days at $r = 200\text{m}$ (neglecting S_g)

Numerical Simulation:

- TORC has not completed any numerical simulation on Sec 28-13-28W1
- Fort Calgary previously completed some numerical simulation (Petrel + Frontsim 2013) on SEC 29-13-28W1

- Their history matched primary production showing very rapid pressure depletion
- Their runs showed recoveries upwards of 30% with near piston-like displacement

EMU No.1 Data:

- Pressure response in 15 days in 3 horizontal wells at a distance of 200m
- Watercuts in responding wells decreased due to additional inflow from Middle Bakken beach
- A group plot with primary and secondary forecasts can be seen in *Appendix E, Figure 1*

Analogous Pool:

- The Daly Bakken A pool and waterflood, operated by Tundra Oil & Gas Ltd., in Sections 21, 28 and 29 TWP 10 RNG 29W1 can be used as a direct analogue
- The Middle Bakken facies in both Daly and Manson area consist of the same upper bioturbated medium to fine silt, middle interlaminated silts and lower coarse silt to fine sand. In both cases, main reservoir thickness is 2 to 4 m. The regional Bakken Shale also offers a pressure boundary
- Daly A Bakken reservoir properties exhibiting similar permeability of 3 to 25md and average porosity of 17%.
- An incremental post-flood recovery factor of 8% was achieved in the Daly Bakken A pool with four vertical incomplete 9 spot injection patterns
- A map showing the Daly Bakken A analogue along with decline analysis for the pool can be seen in *Appendix C, figure 5 & 6* respectively

Secondary Recovery and Production Forecast

TORC believes that incremental recovery upwards of 5% can be forecasted in the Manson Section 28 flood with the proposed injection scheme where horizontal injectors will allow for uniform lateral sweep from well paths. Furthermore, inflatable packers will enable adaptable injection patterns by isolating chosen injection intervals and know heterogeneity or fractured areas can subsequently be avoided. Selective intervals can also be mirrored in the horizontal producers to isolate or delay breakthrough.

Recovery has been calculated for the WF area based on forecasted individual well declines under pressure support. An elevated economic cut-off of 0.4 m³/d of oil was used in this scenario as fixed injection well costs were allocated to the remaining producers. The resultant post flood EUR is 64.0 e3m³ which yields an incremental and ultimate post flood recovery factors of 5.0% and 6.2% respectively. Forecasted production profiles for both primary and waterflood can be seen in *Appendix C, figure 4*.

After water flood implementation, project success will be evaluated by:

- Recording continuous incremental recovery
- Recovery comparisons with adjacent sections, forecasted recovery and Sinclair analogues

Appendix A: Unit & Notification

Appendix A, Figure 1: East Manson Unit No.6 Map

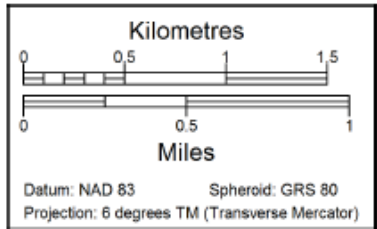
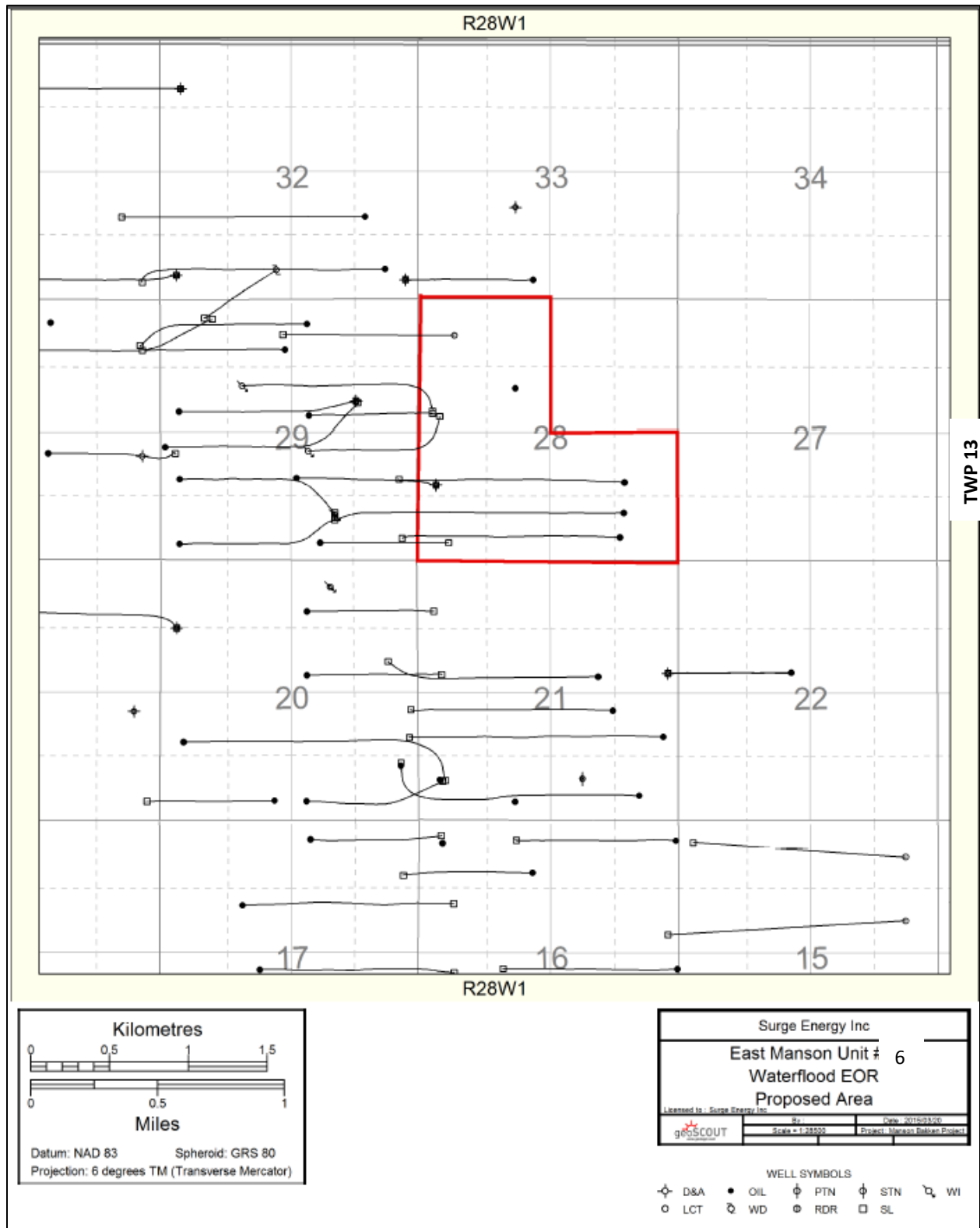

Surge Energy Inc

East Manson Unit # 6

Waterflood EOR

Proposed Area

Licensed to: Surge Energy Inc

By: Date: 2014/03/20

Scale: 1:25000 Project: Manson Bakken Project

- WELL SYMBOLS**
- D&A
 - OIL
 - PTN
 - STN
 - WI
 - LCT
 - WD
 - RDR
 - SL

Appendix A, Figure 2: Sample Notification Letter

May XX, 2015

Surface / Mineral Holder
360-1395 Ellice Avenue
Winnipeg, Manitoba
R3G 3P2

**RE: TORC MANSON UNIT NO. 6 PROPOSAL & WATER FLOOD:
LSD's 1 to 8, & 11 to 14 SEC 28 TWP 13 RNG 28 W1**

Please be advised that TORC Oil & Gas Ltd will be applying under Section 71 of the Manitoba Drilling and Production Regulations for a water flood in LSDs 1 to 8, & 11 to 14 of SEC 28 TWP 13 RNG 28 W1 (see attached unit and waterflood area map). Upon approval of the unit and waterflood application, the following wells will be converted to Bakken / Three Forks water injectors:

(02-29) 102/01-28-013-28W1 HZ (conversion)
(11-28) 100/11-28-013-28W1 Vertical (conversion)

Injected water will be transported via flow line to the above wells from the TORC 13-29-13-28W1 battery site. Source water will be Bakken / Three Forks produced water along with Jurassic water from the 15-30-13-28W1 source well.

Should you have any questions or concerns with respect to the above mentioned project, please direct them to the Engineering Manager, Saskatchewan – Kristine Michie at (403) 930-4167 or kmichie@torcoil.com.

Sincerely,

TORC OIL & GAS LTD by its agent,
Millenium Land Ltd.

J. Travis Veldhuis
Land Agent

Appendix A, Figure 3: Tract Factors – EMU #6

East Manson Unit No. 6								
Legal Description	Royalty Owner	Working Interest	OOIP (e3m3)	Wellbores	Oil Production		Volume Allocation (e3m3)	Tract Factor
					Cum production per Well (e3m3)	Production Allocation		
1-28-13-28W1	100% Crown	100% Surge Energy Inc.	32.8	100/01-28-013-28W1/0	2.32	10%	32.3	4.129%
				102/01-28-013-28W1/0	2.19	10%		
2-28-13-28W1	100% Crown	100% Surge Energy Inc.	65.5	100/01-28-013-28W1/0	2.32	30%	64.1	8.187%
				102/01-28-013-28W1/0	2.19	30%		
3-28-13-28W1	100% Crown	100% Surge Energy Inc.	74.5	100/01-28-013-28W1/0	2.32	30%	73.1	9.336%
				102/01-28-013-28W1/0	2.19	30%		
4-28-13-28W1	100% Crown	100% Surge Energy Inc.	87.6	100/01-28-013-28W1/0	2.32	30%	86.2	11.008%
				102/01-28-013-28W1/0	2.19	30%		
5-28-13-28W1	100% Crown	100% Surge Energy Inc.	99.5	100/08-28-013-28W1/0	1.84	30%	98.9	12.629%
6-28-13-28W1	100% Crown	100% Surge Energy Inc.	80.5	100/08-28-013-28W1/0	1.84	30%	79.9	10.204%
7-28-13-28W1	100% Crown	100% Surge Energy Inc.	55.4	100/08-28-013-28W1/0	1.84	30%	54.8	7.000%
8-28-13-28W1	100% Crown	100% Surge Energy Inc.	28.4	100/08-28-013-28W1/0	1.84	10%	28.2	3.601%
11-28-13-28W1	100% Crown	100% Surge Energy Inc.	67.4	100/11-28-013-28W1/0	0.14	100%	67.3	8.584%
12-28-13-28W1	100% Crown	100% Surge Energy Inc.	87.8				87.8	11.206%
13-28-13-28W1	100% Crown	100% Surge Energy Inc.	72.9				72.9	9.304%
14-28-13-28W1	100% Crown	100% Surge Energy Inc.	37.7				37.7	4.812%
Total			790.0				783.5	100.0%

Appendix B: Geological Maps

Appendix B, Figure 1: Upper Bakken Structure Contour Map

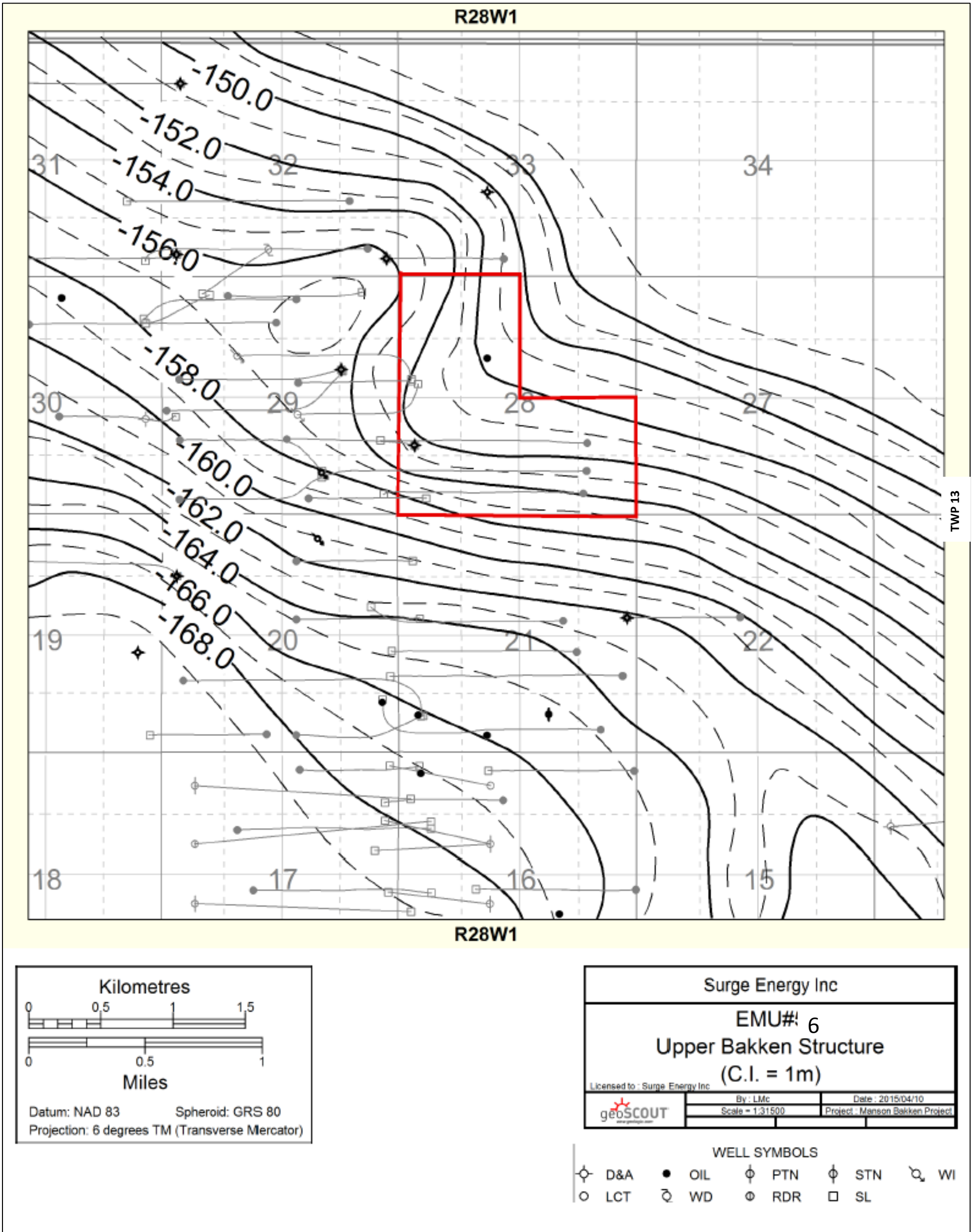

Appendix B, Figure 2: Middle Bakken Siltstone Structure Contour Map

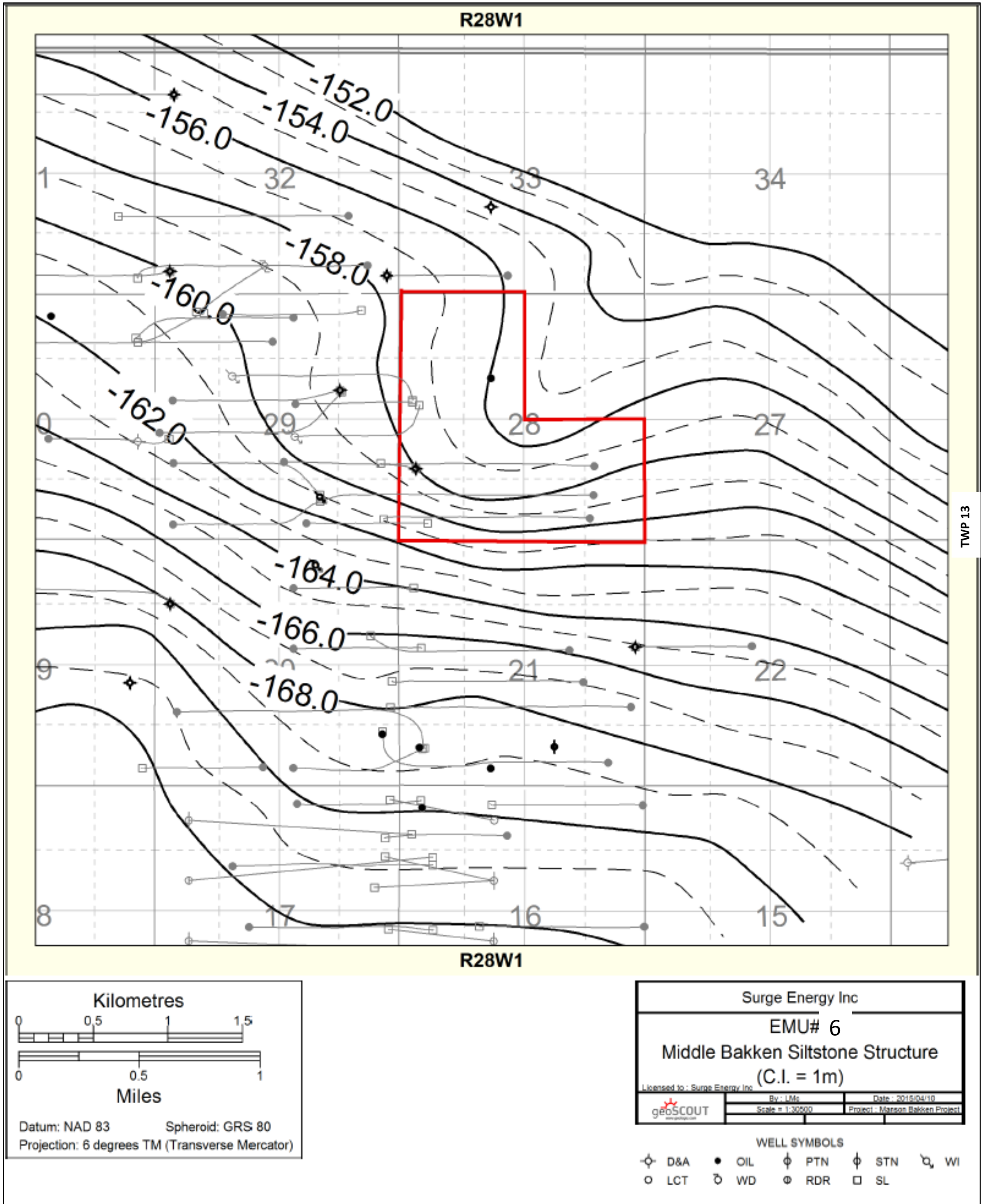

Appendix B, Figure 3: Torquay (Middle Bakken Unconformity) Structure Contour Map

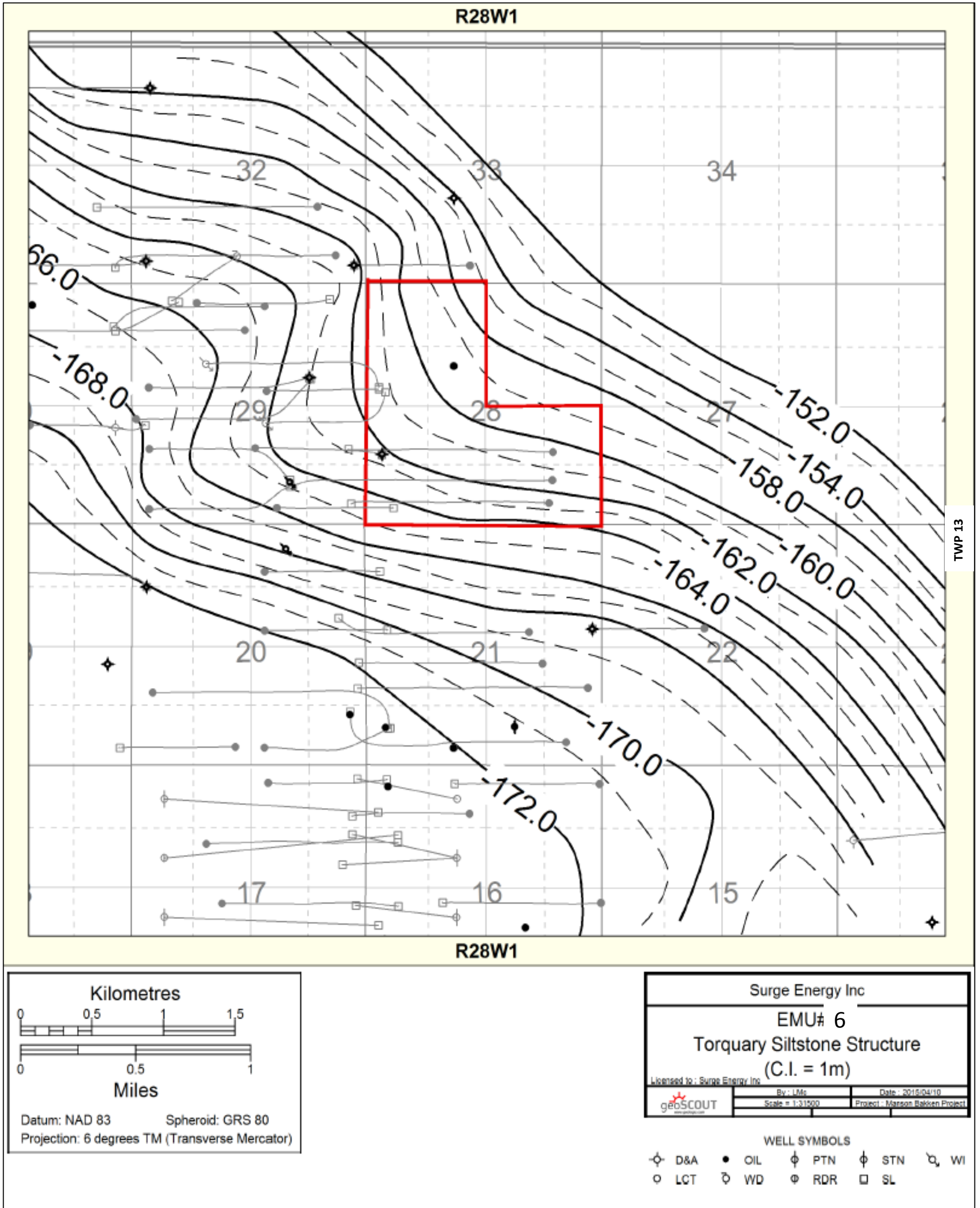

Appendix B, Figure 4: Torquay Unit 2 (Middle Bakken Unconformity) Structure Contour Map

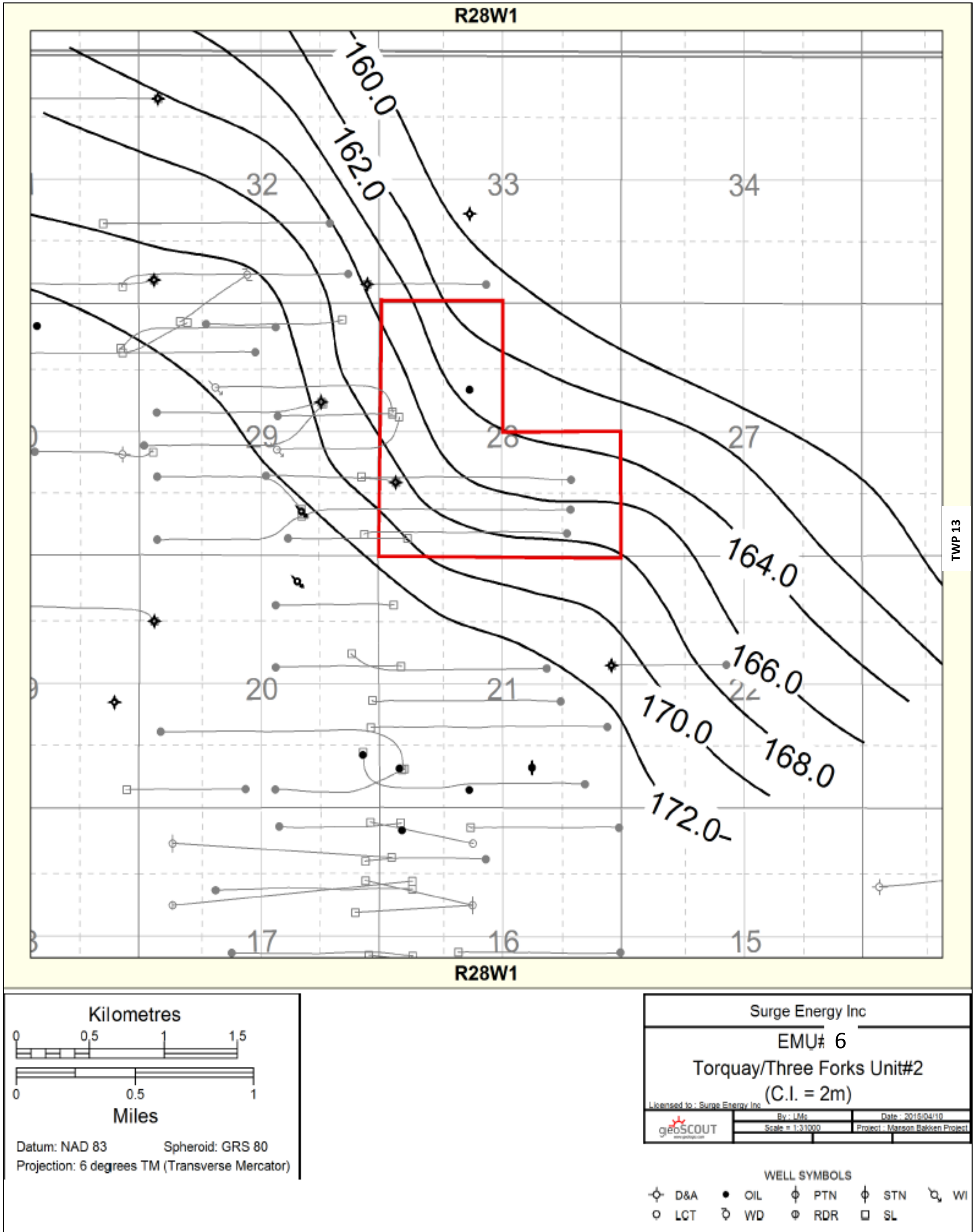

Appendix B, Figure 5: Middle Bakken Siltstone Reservoir Isopach

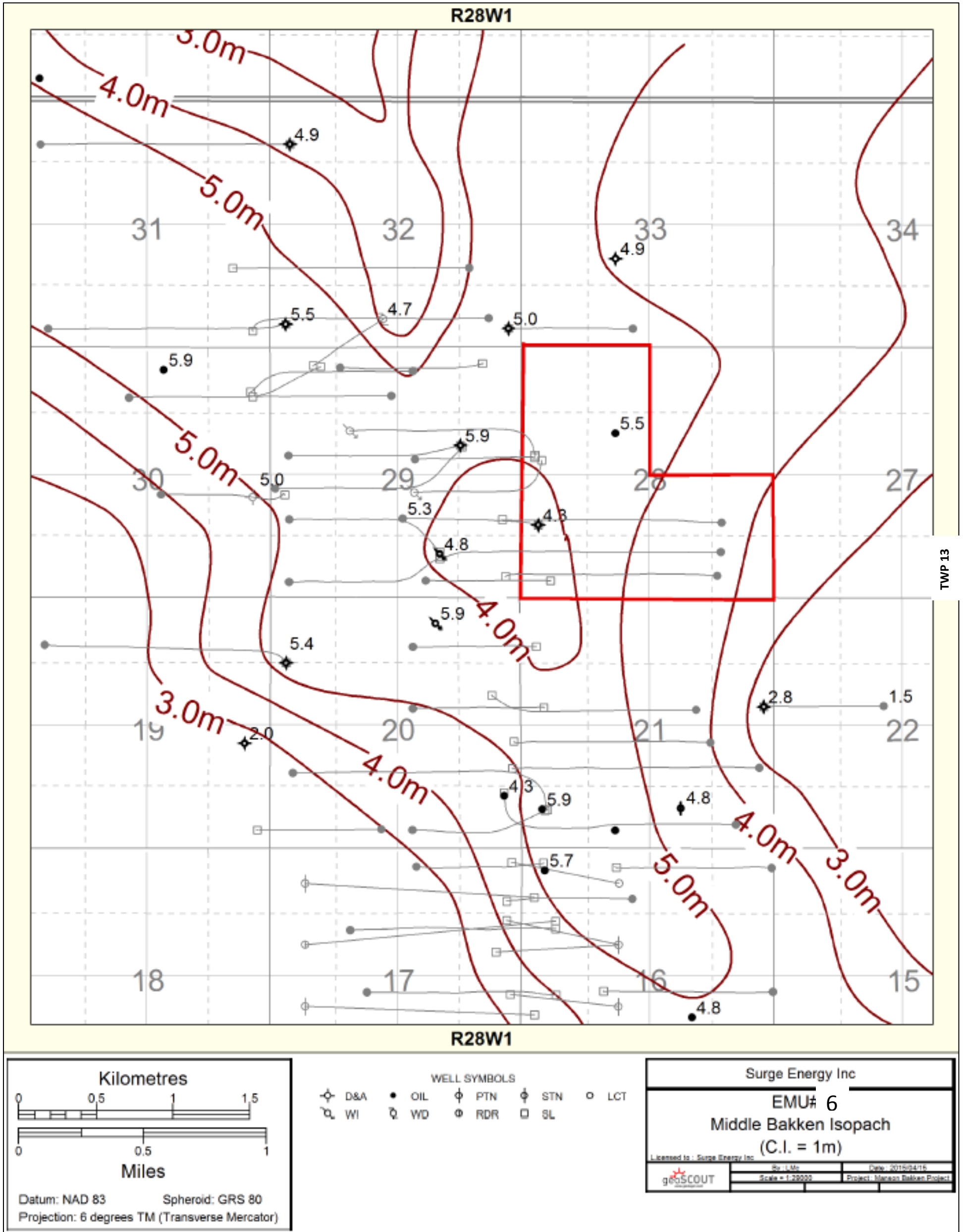

TWP 13

Appendix B, Figure 6: Torquay Siltstone Isopach Map

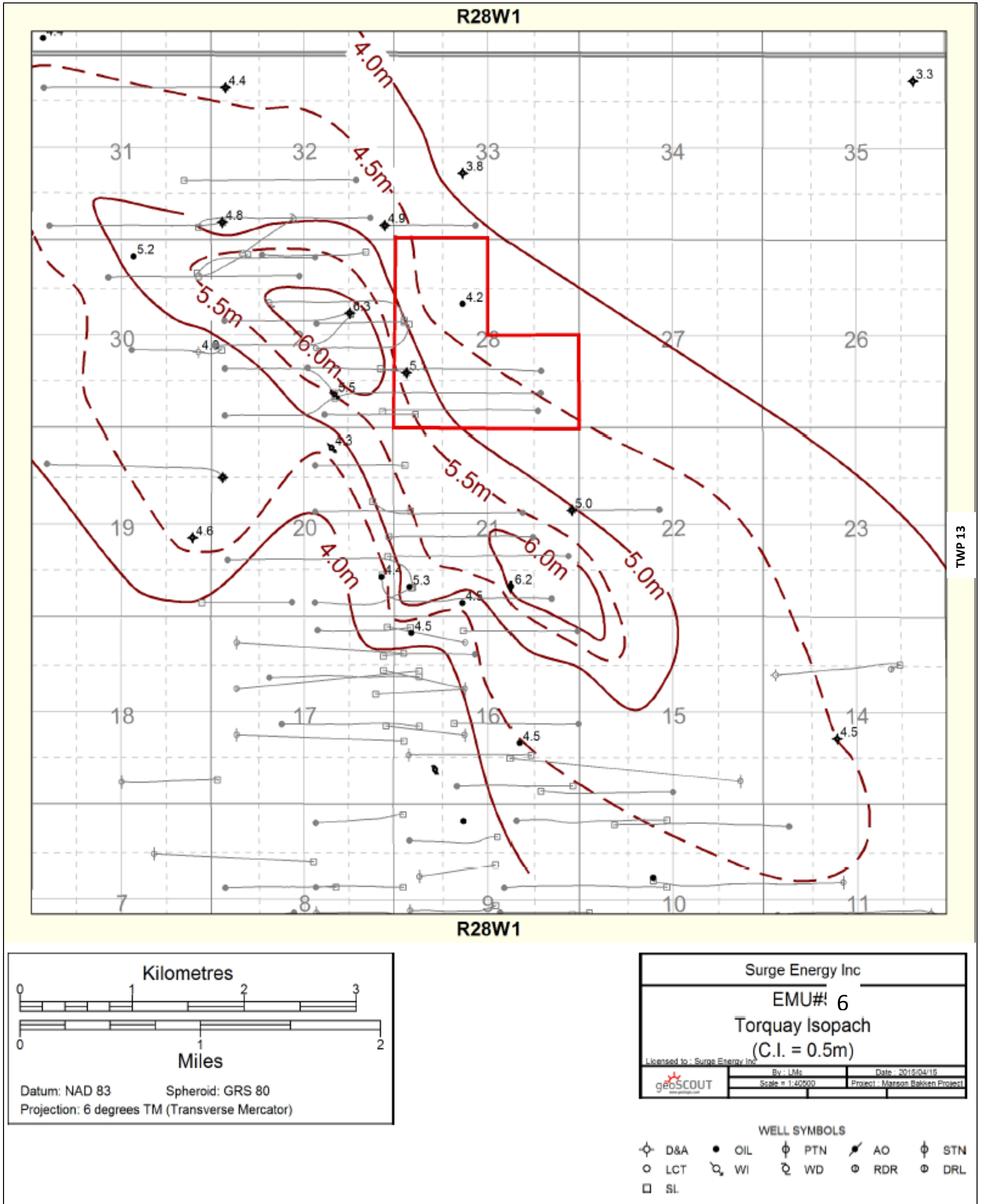

Appendix B, Figure 7: Phi-h Map of the Middle Bakken Reservoir (1 md Cutoff)

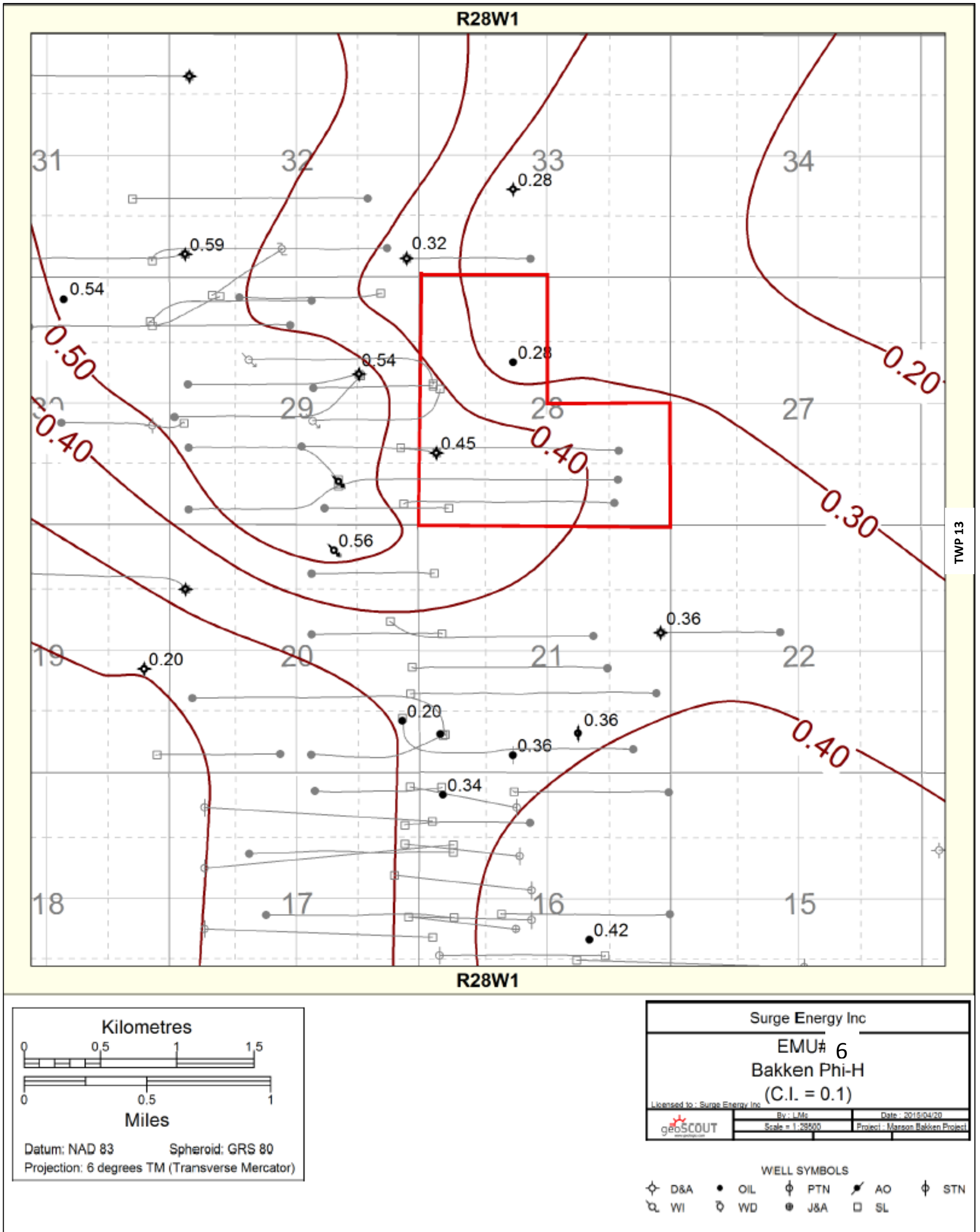

Appendix B, Figure 8: K-h Map of the Middle Bakken Reservoir (1 md Cutoff)

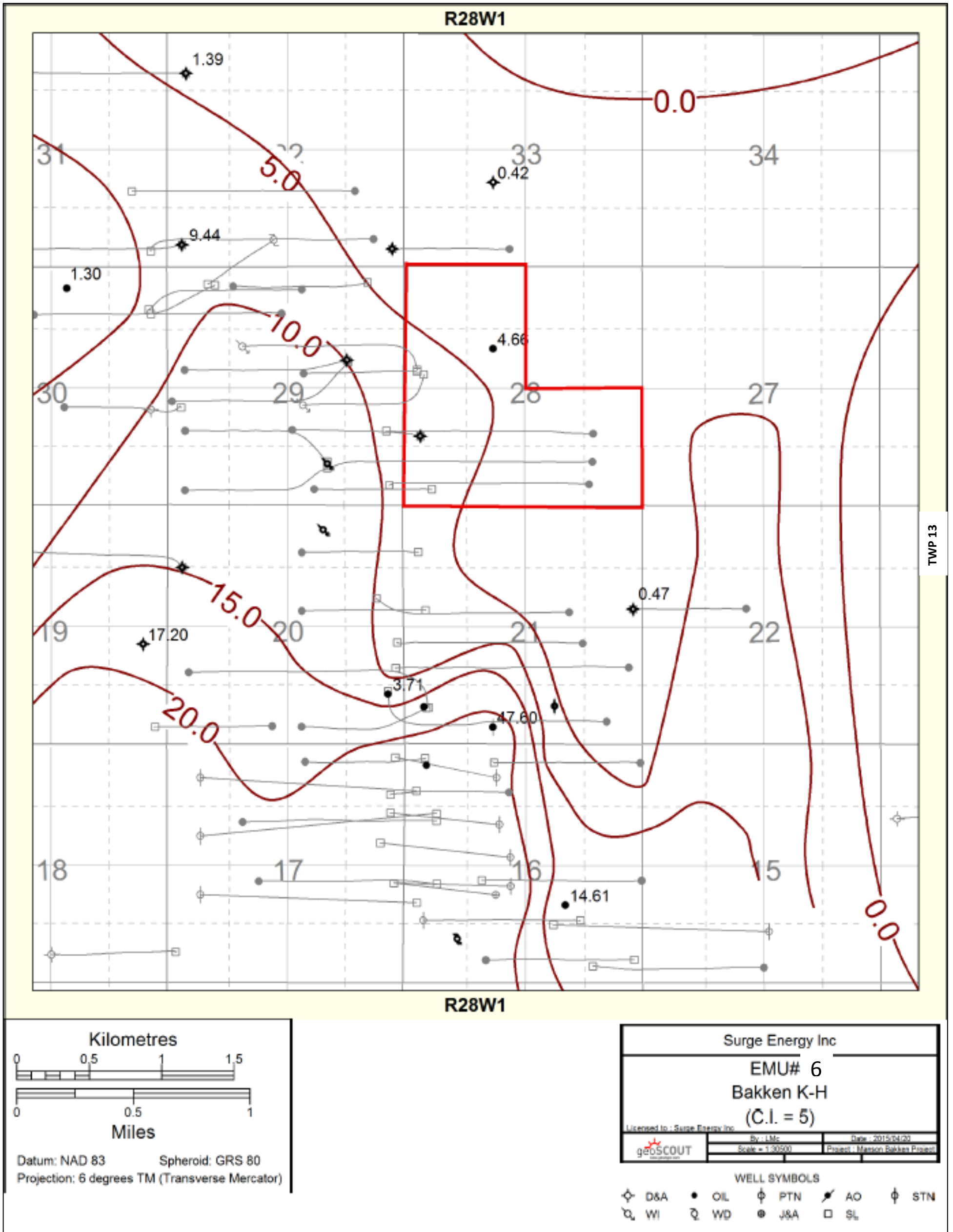

Appendix B, Figure 9: Torquay Net Pay Map

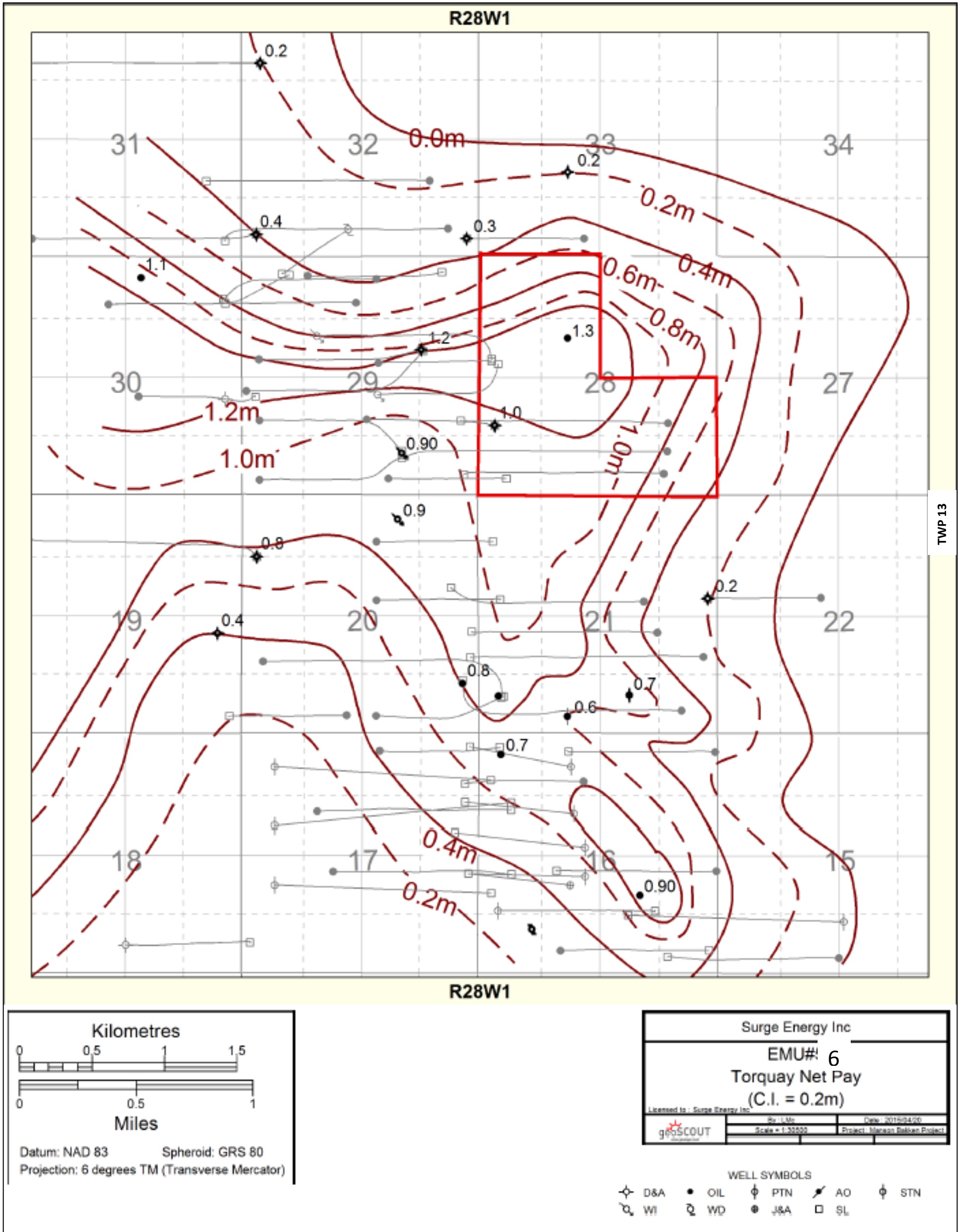

TWP 13

Appendix B, Figure 10: Porosity-Permeability Cross Plot

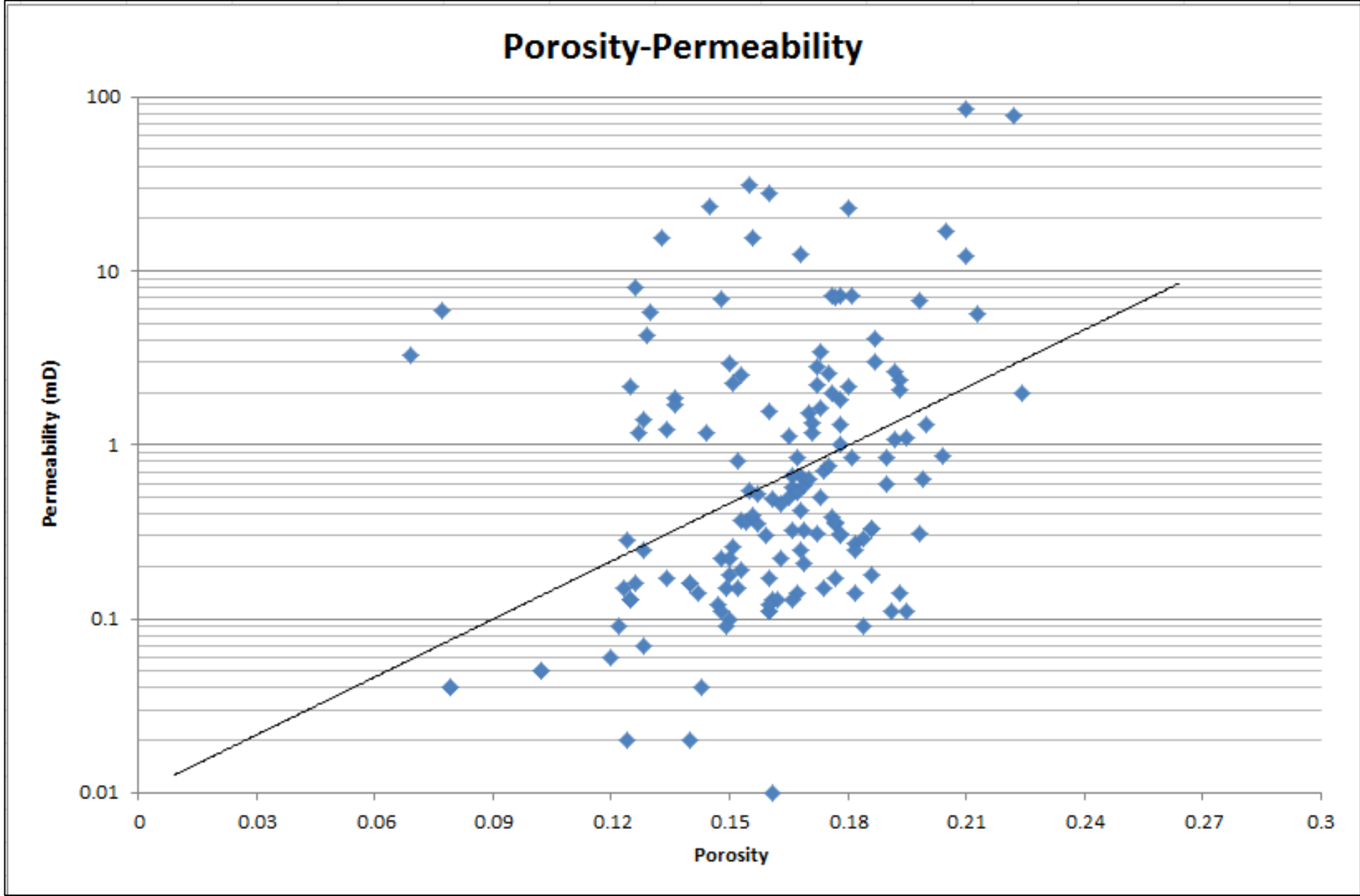

(Data set = 12 cores; Middle Bakken Siltstone)

Appendix B, Figure 11: Stratigraphic Cross Section A-A' (Northwest to Southeast) across EMU No.6

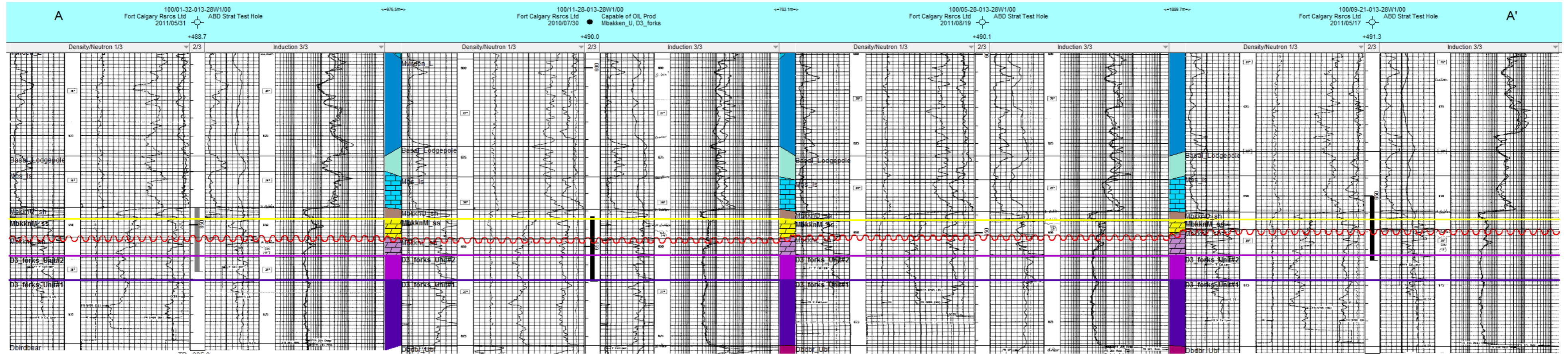

Appendix B, Figure 12: Structural Cross Section A-A' (Northwest to Southeast) across EMU No.6

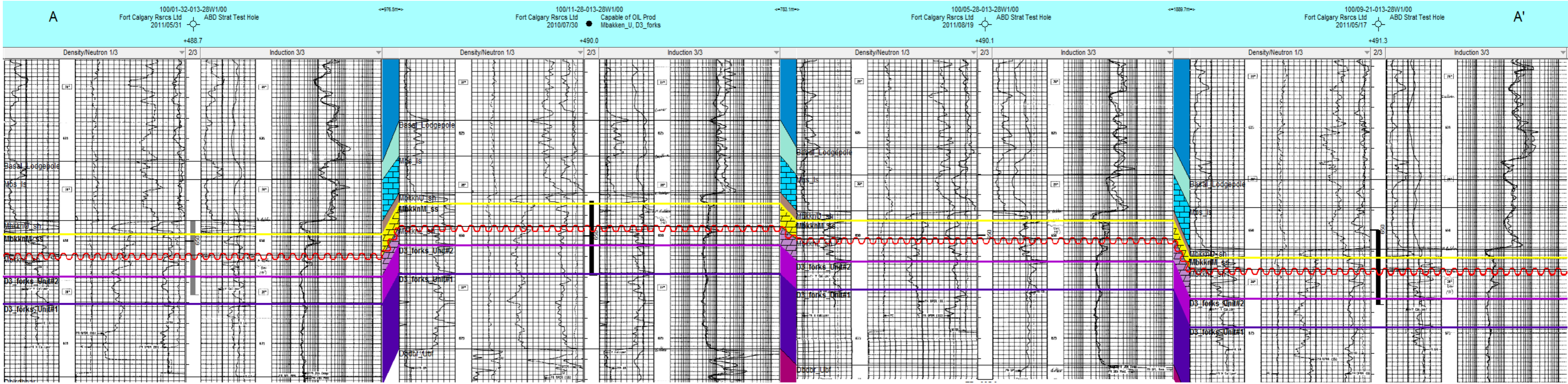

Appendix C: Reservoir Characteristics & Recovery

Appendix C, Figure 1: East Manson Unit No.6 (NW ¼ and S ½ Sec 28-13-28W1) OOIP

East Manson Unit No. 6				
	Bakken		Torquay	
Legal Description	OOIP (e3m3)	OOIP (mdbl)	OOIP (e3m3)	OOIP (mdbl)
1-28-13-28W1	24.9	156.6	7.9	49.7
2-28-13-28W1	51.2	322.0	14.3	89.9
3-28-13-28W1	58.6	368.6	15.9	100.0
4-28-13-28W1	71.7	451.0	15.9	100.0
5-28-13-28W1	80.5	506.3	19	119.5
6-28-13-28W1	61.5	386.8	19	119.5
7-28-13-28W1	39.5	248.4	15.9	100.0
8-28-13-28W1	20.5	128.9	7.9	49.7
11-28-13-28W1	46.8	294.4	20.6	129.6
12-28-13-28W1	68.8	432.7	19	119.5
13-28-13-28W1	58.6	368.6	14.3	89.9
14-28-13-28W1	23.4	147.2	14.3	89.9
Total	606.0	3811.6	184	1157.3
			Total Section 28 OOIP (e3m3)	790.0
			Total Section 28 OOIP (mdbl)	4969.0
Sw = 23% (Based on petrophysical evaluation of the 100/02-29 vertical wellbore)				
Bo (res m3/m3) = 1.01				

Appendix C, Figure 2: S ½ & NW ¼ SEC 28-13-28W1 Production History

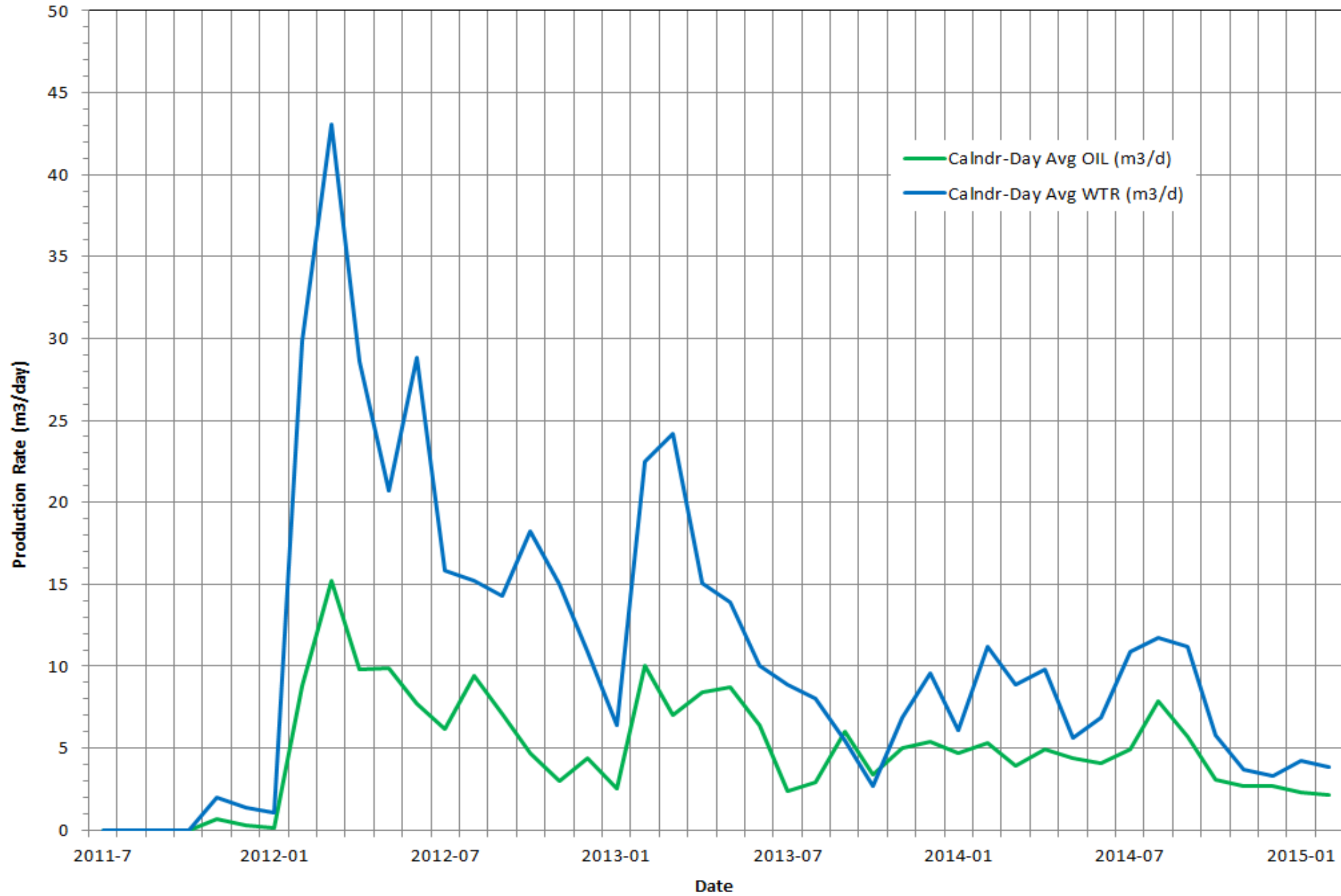

Appendix C, Figure 3: S ½ & NW ¼ SEC 28-13-29W1 Production Rate vs Cumulative Production

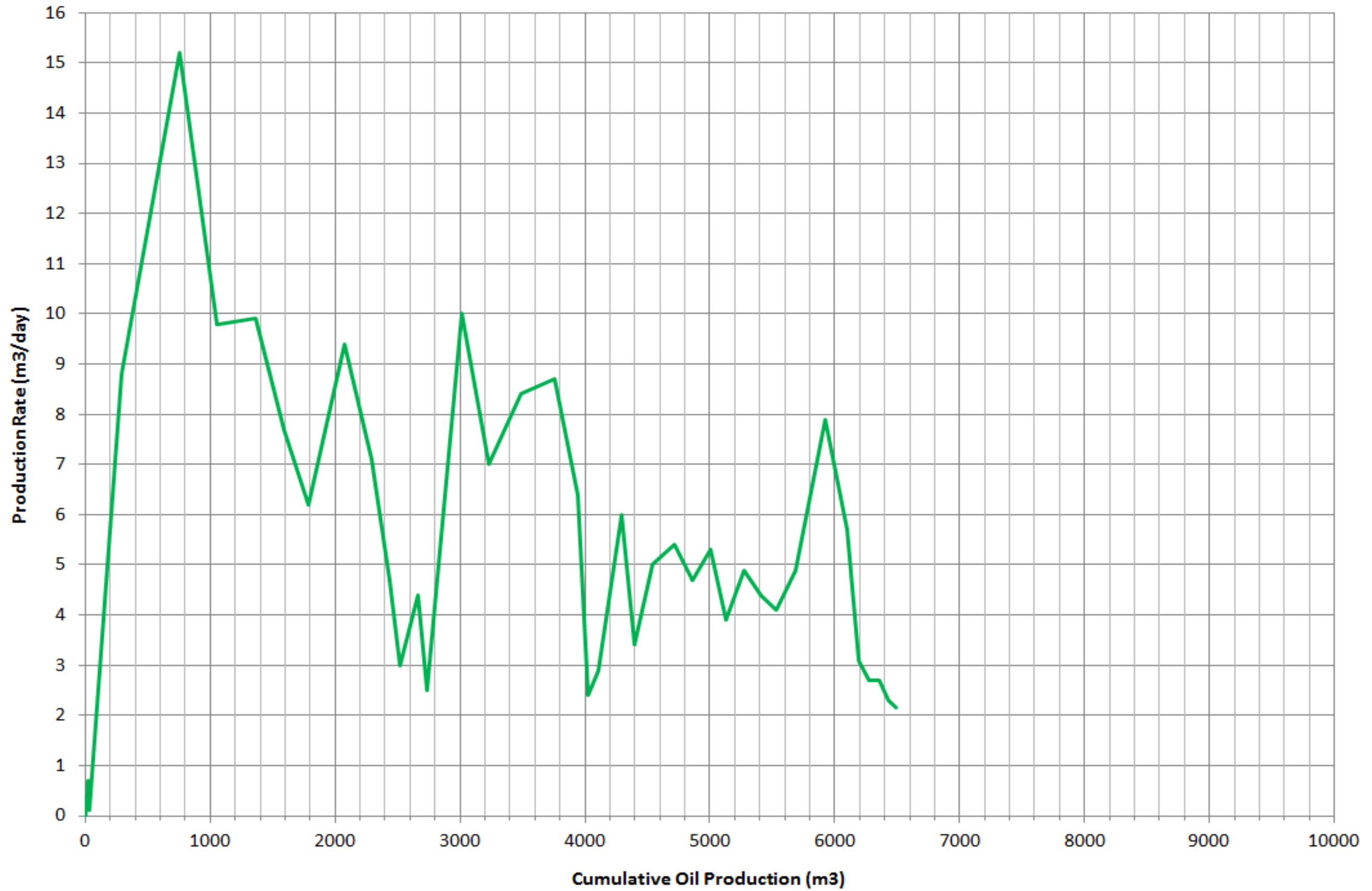

Appendix C, Figure 4: East Manson Unit No.6 Production Forecasts

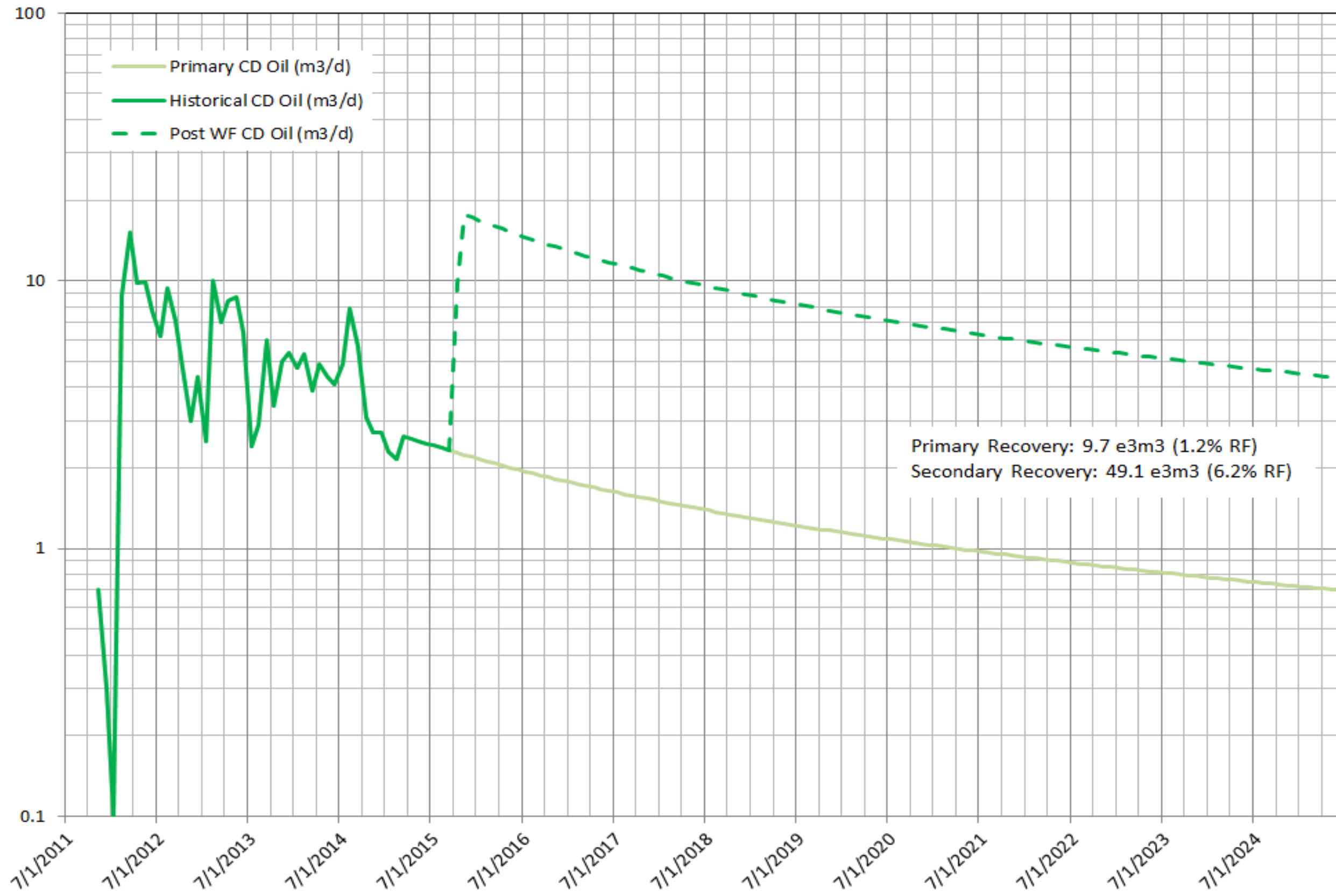

Appendix C, Figure 5: Daly Bakken A Analogue Map

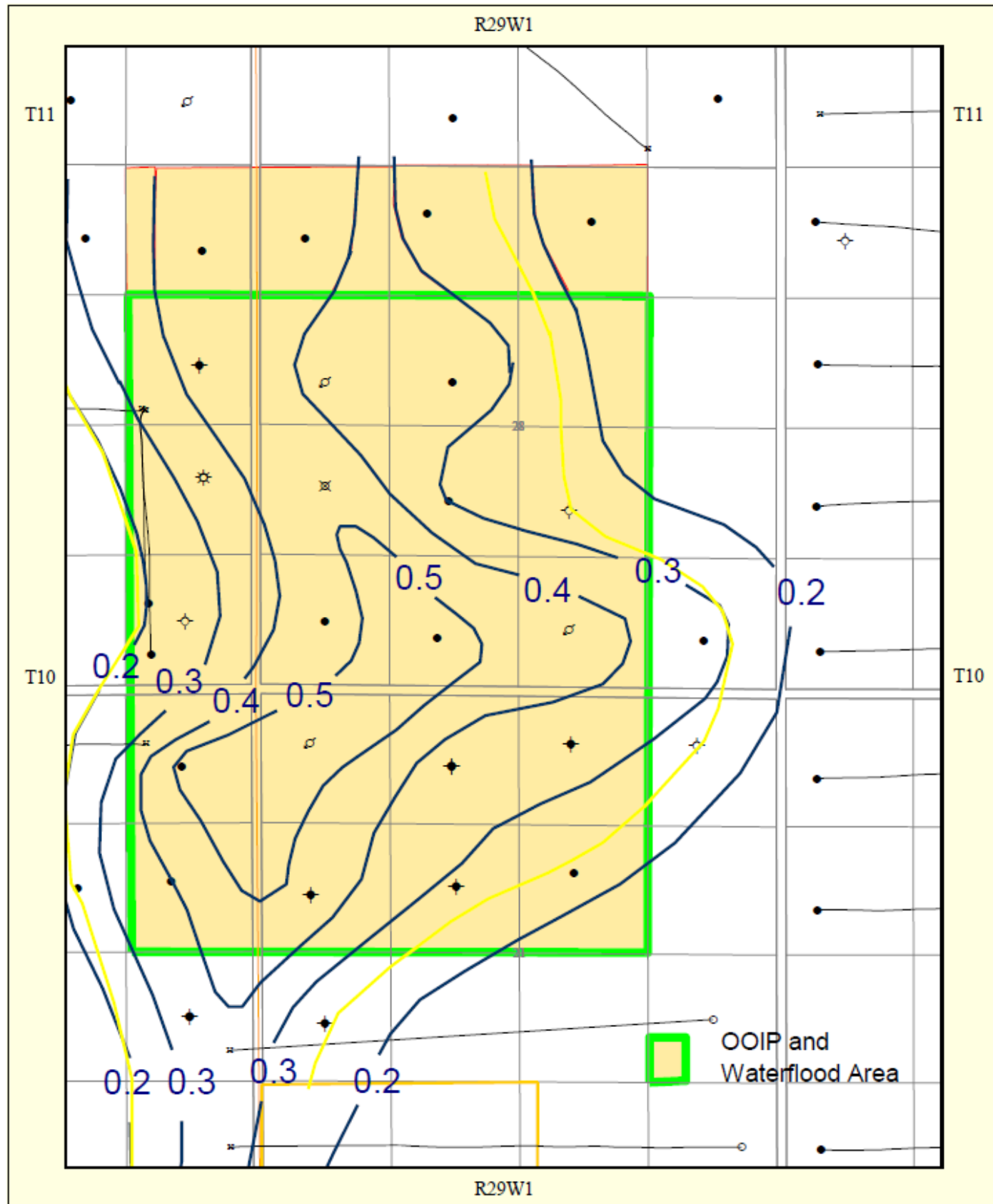

WELL LEGEND	
Bottom Hole Locations:	
○ Location	□ Service or Drain
● Oil	◇ Dry & Abandoned
★ Abandoned Oil	✖ Abandoned Service
⊕ Injection	
Surface Hole Locations:	
—○ Horizontal	

PROPRIETARY DATA LEGEND	
Regions:	
	Fort Calgary Land

Scale 1:18329

0 0.5
Kilometers
0 0.5
Miles

Fort Calgary Resources Ltd.

Phi - h Map (m)

<p>Created in AecaMap™ Product of IHS Datum: NAD83 V14 22 Nov 11, Nov 12 2012 (40) 76-666</p>	<p>Author: David Rose Date: December 13, 2012 File: Kola phi-h.MAP Scale: 1 : 18329 Projection: Stereographic Center: N49.85929 W101.36174</p>
<p>Grid Information: DLS: IHS Enhanced Grid NTS: Theoretical Grid FPS: Theoretical Grid US: IHS US Grid</p>	<p>DLS Version Information: AB: ATS 4.1 BC: PRB 2.0 SK: STS 2.5 MB: MI 107</p>

Appendix C, Figure 6: Daly Bakken A Analogue Recovery

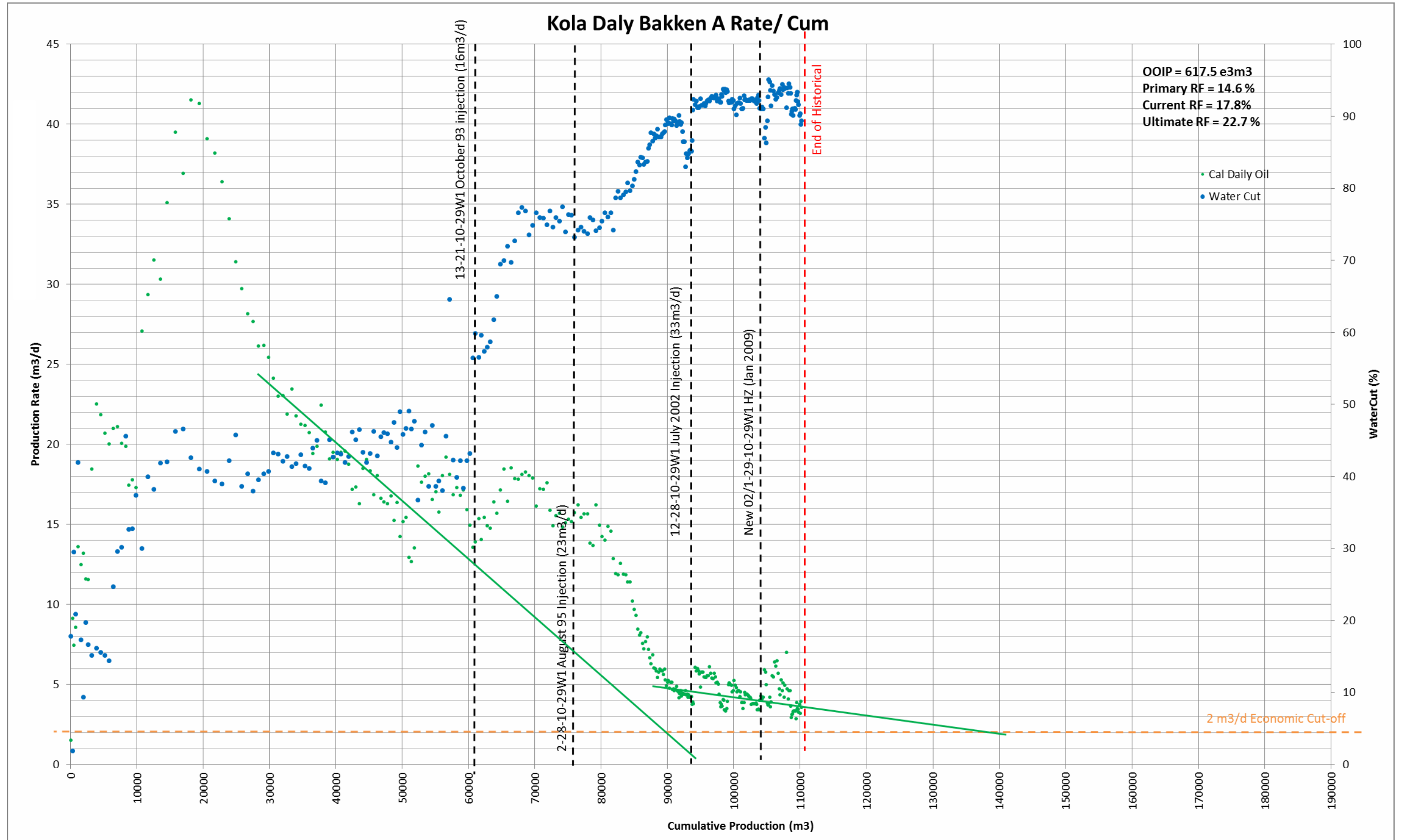

Appendix D: Proposed Waterflood Design

Appendix D: Figure 1 Typical Horizontal Injector Schematic

TORC Oil & Gas Ltd PRODUCTION EQUIPMENT

LOCATION: TORC Oil & Gas East Manson Typical HZ Injector DATE: _____
 KB ELEV. (m): 487.86 KB - CF (m): 4.30 KB - THF (m): 3.92

All depths are in MKB

WELLHEAD SERIES: 1 1/2 "R-53 x 7 1/16" MAKE: Stream flo / # 3000 (FLANGED) SCREWED
 MASTER VALVE: MAKE: SIZE: _____
 CASING VALVE: MAKE: SIZE: _____
 CHOKE: MAKE: _____
 OTHER: _____

SURFACE CASING: 244.5 mm x 48.1 kg/m, H-40 ST&C, J-55. Landed at 137.0 mKB.
 PRODUCTION CSG: 177.8 mm x 29.76 / 34.23 kg/m, J-55, LT&C & ST&C. Landed at 772.0 mkb

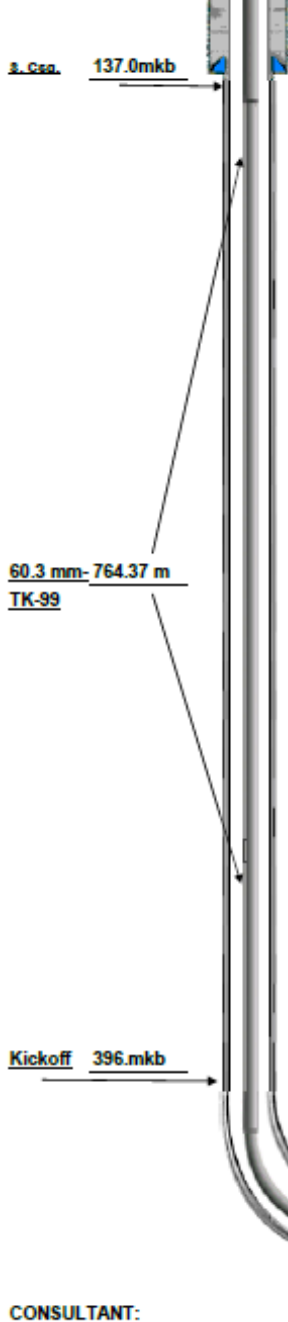

DESCRIPTION (from top down)	TUBING LENGTH m	BOTTOM SET @ mKB	REMARKS
1 - 60.3 mm x 7 1/16 Coated Hanger	0.18	4.10	
78 - 60.3 mm x 6.99 kg/m EuE Tubing	760.27	764.37	TK-99 Coated Tubing
1 - 60.3 mm API / Psn	0.34	764.71	Coated Api / Psn
1 - 60.3 mm x 73 mm Cross-Over	0.23	764.94	Coated Cross Over
Top of Packer to CE	1.05	765.99	Tryton Double grip/Coated
CE - Bottom of Packer	1.20	767.19	Tryton Double grip/Coated
1 - 73 mm Coated EuE Pup Joint	1.24	768.43	Coated Pup Joint
1 - 73 mm Re-Entry Guide Shoe	0.13	768.56	Coated Re-Entry Guide
		768.56	

Note: Casing inhibited with 15.0 m3 Fresh inhibited water / Pure Chemical CPF-199 inhibitor

WellHead Info: Tubing Hanger - 7 1/16 X 60.3 MM Coated
 Tubing Bonnet : 7 1/16 " x 3000 psi
 Companion Flange - Coated 2 1/16 x 5000 psi /Aum Gate valve

TOTAL STRING LENGTH	764.64
KB TO THF	3.92
SETTING DEPTH (mKB)	768.56

Open Hole (mKB): (159 mm Open Hole) 772.0 mkb To 2354.0 Mkb

REMARKS: Note: this represents a typical horizontal torquay injection well. Depths will var

Tryton CE - 765.99 m / Double Grip Injection packer TMD 2354.0mkb
 ICP - 772.0 Mkb TVD (@ end) 649.76 mkb

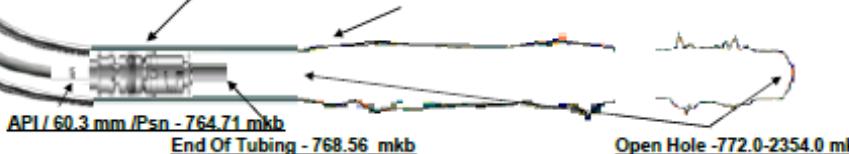

CONSULTANT:

Appendix D, Figure 2: Injection Diagram

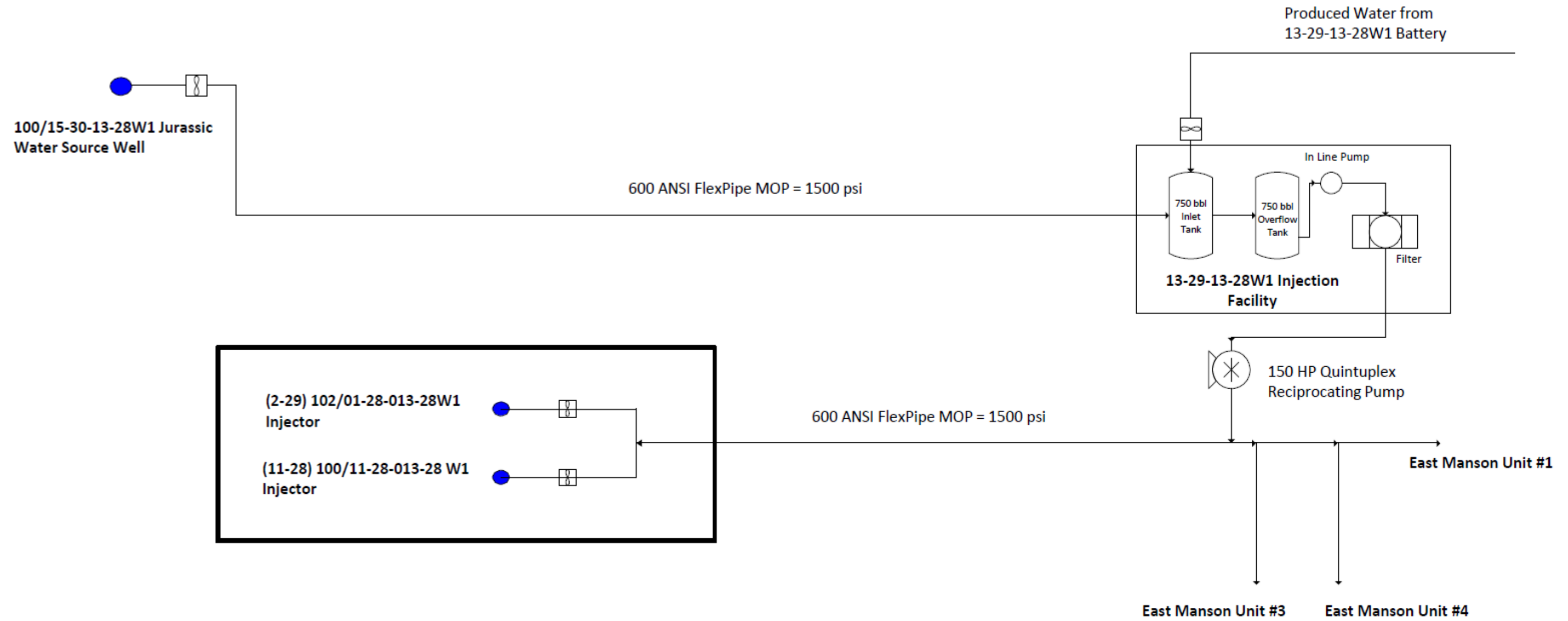

Appendix D, Figure 3: Injection Scheme

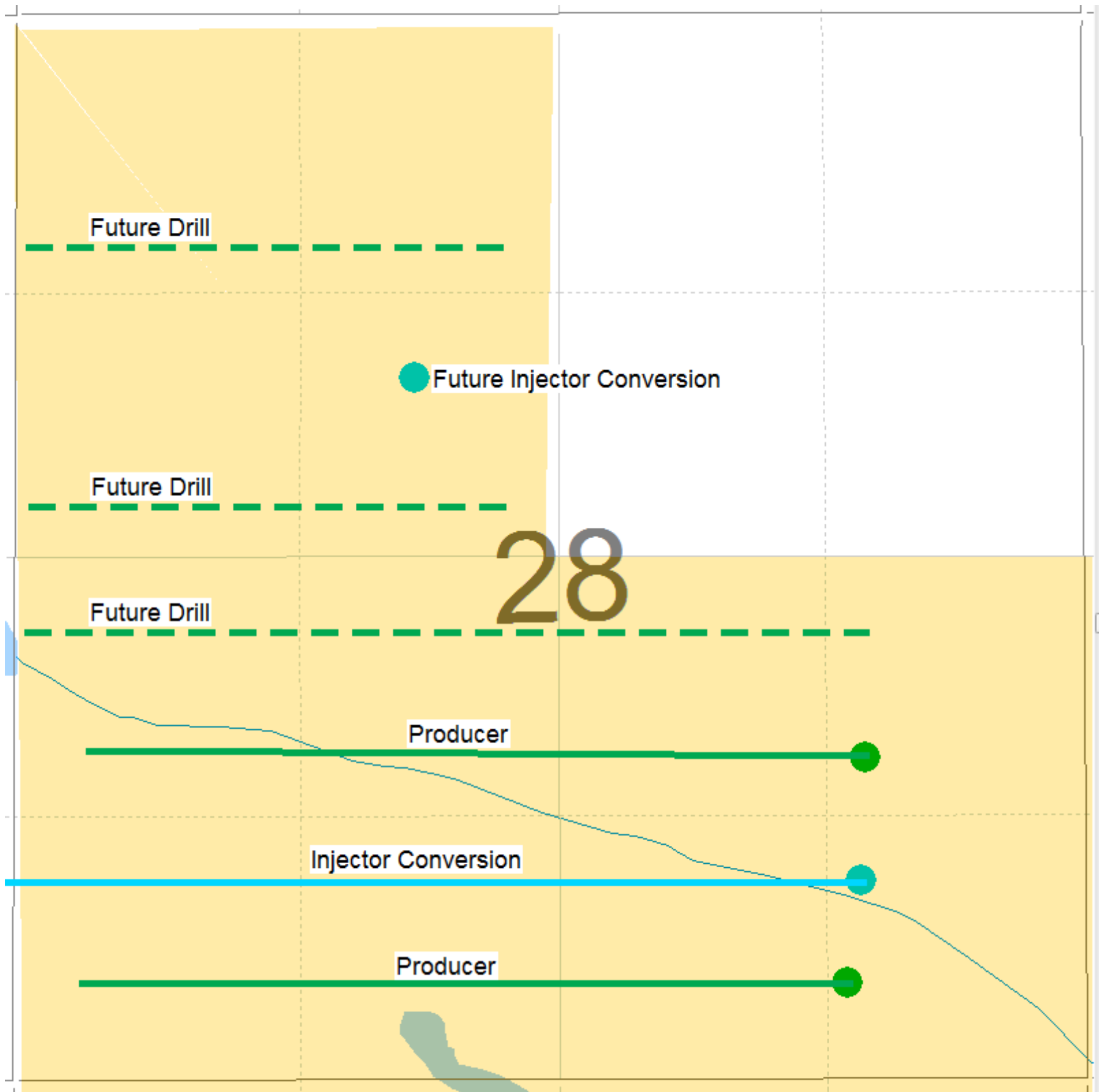

Appendix D, Figure 4: Corrosion Control

East Manson Unit No.6 Corrosion Control Program

Surface Lines:

- All surface flow lines will consists of Flexpipe reinforced polyethylene pipe and/or fiberglass, both of which are corrosion resistant.
- Surface lines to injection wells will have a maximum allowable pressure of 1500 psi
- Stainless steel valves and fittings
- Isolation valves at wellheads and injection facility
- High and low pressure shut-down

Injection Facilities

- Internally coated storage tanks
- Stainless steel filtration system
- Pump unit consisting of stainless steel plungers, and stainless steel disc valves

Injection Wells

- Injector tubing will be fusion epoxy coated (FBE)
- Casing, tubing and wellhead cathodic protection
- Corrosion resistant surface lines (stainless steel or fiberglass) and master valves
- Inhibited water in annular space

Producing and Source Wells

- Fusion epoxy coated tubing
- Downhole corrosion inhibitor batch treatments and/or continuous injection of corrosion inhibitor
- Cathodic protection

Appendix E – EMU No. 1 Waterflood Response

Appendix E, Figure 1: EMU No. 1 Sec 29-13-28W1 Waterflood Response

