

PROPOSED EWART UNIT NO. 12

Application for Enhanced Oil Recovery Waterflood Project

Lodgepole Formation

Lodgepole A (01 59A)

Daly Sinclair Field, Manitoba

December 5th, 2016
Tundra Oil and Gas Partnership

INTRODUCTION

The Daly Sinclair oilfield is located in Townships 8, 9, 10 and 11, of Ranges 27, 28 & 29 WPM (Figure 1). Within the Daly Sinclair oilfield, most Lodgepole reservoirs have been developed with vertical producing wells on Primary Production and 40 acre spacing. Horizontal producing Lodgepole wells have recently been drilled by Tundra Oil and Gas (Tundra) in the southern part of the Daly Sinclair field.

Within the area, potential exists for incremental production and reserves from a Waterflood Enhanced Oil Recovery (EOR) project in the Lodgepole oil reservoir. The following represents an application by Tundra Oil and Gas Partnership (Tundra) to establish Ewart Unit No. 12 (S/2 20-008-28W1) and implement a Secondary Waterflood EOR scheme within the Lodgepole formation as outlined on Figure 2.

The proposed project area falls within the existing designated Lodgepole A Pool of the Daly Sinclair Oilfield (Figure 3).

SUMMARY

1. The proposed Ewart Unit No. 12 consists of 2 horizontal producing Lodgepole wells and 3 new horizontal wells waiting to be produced. The area of the proposed Ewart Unit No. 12 comprises 8 Legal Sub Divisions (LSD), and is located south of Ewart Unit No. 9 (Figure 2).
2. Total Original Oil in Place (OOIP) in the project area is estimated to be **858.1** e³m³ (5,397 Mbbbl) for an average of **107.3** e³m³ (675.4 Mbbbl) OOIP per 40 acre LSD. OOIP values were estimated by contouring phi*h values and applying volumetric methods.
3. Cumulative production to the end of August 2016 from the 2 producing Lodgepole wells within the proposed Ewart Unit No. 12 project area is 15.78 e³m³ (99.3 Mbbbl) of oil and 2.37 e³m³ (14.9 Mbbbl) of water, representing a **1.8%** Recovery Factor (RF) of the OOIP.
4. Figure 4 shows that the oil production rate in the Ewart Unit No. 12 area peaked during April 2014 at 39.8 m³ (259 bbl) of oil per day (OPD) when developed with horizontal wells at 400m inter-well spacing. As of August 2016, production was 9.78 m³ (61.6 bbl) OPD, 0.92 m³ (5.8 bbl) water per day (WPD) and an 8.6% water cut (WCUT). Drilling 3 additional infill horizontal wells in 2016 at 100m inter-well spacing will result in a new peak rate from this area in December 2016 estimated to be approximately 72 m³ (452 bbl) of oil per day (OPD).
5. In April 2014, production averaged 19.9 m³ (125 bbl) OPD per well in the proposed Ewart Unit No. 12. As of August 2016, average per well production has declined to 4.89 m³ (30.8 bbl) OPD. The wells drilled at 400m spacing will continue declining at an annual rate of approximately **17%** in the project area.
6. Estimated Ultimate Recovery (EUR) of Primary producing oil reserves in the proposed Ewart Unit No. 12 project area is estimated to be 42.98 e³m³ (270 Mbbbl), with 27.2 e³m³ (171 Mbbbl) remaining as of the end of August 2016 when developed at 400m spacing. Infill drilling the 3 additional horizontal wells at 100m spacing is estimated to increase primary EUR to 89.72 e³m³ (565 Mbbbl), with 73.94 e³m³ (465 Mbbbl) remaining at the end of August 2016.
7. Ultimate oil recovery of the proposed Ewart Unit No. 12 OOIP, under the current Primary production method, is forecasted to be **10.5%**.
8. Estimated Ultimate Recovery (EUR) of oil under Secondary Waterflood EOR for the proposed Ewart Unit No. 12 is estimated to be 126.8 e³m³ (797 Mbbbl). An incremental 37.1 e³m³ (233 Mbbbl) of oil is forecasted to be recovered under the proposed Unitization and Secondary EOR production, versus the Primary production method.
9. Total RF under Secondary WF in the proposed Ewart Unit No. 12 is estimated to be **14.8%**.
10. There are no nearby Lodgepole Dolomite waterflood analogues with enough waterflood history at this time. However, based on simulation, results of Primary production and successful waterfloods in the Permian basin of carbonate reservoirs with similar reservoir characteristics, the proposed project area is thought to be suitable reservoir for successful EOR trial.
11. Horizontal producers with multi-stage hydraulic fractures, will be converted to injectors (Figure 5) within the proposed Ewart Unit No. 12, to complete waterflood patterns with 100m Horizontal to Horizontal spacing. There is a possibility 2 additional producers may be drilled within the proposed unit, however, the production associated with these wells was not considered for this unit application.

DISCUSSION

The proposed Ewart Unit No. 12 project area is located within Township 8, Range 28 W1 of the Daly Sinclair oilfield (Figure 1). The proposed Ewart Unit No. 12 currently consists of 2 producing horizontal Lodgepole wells, 3 standing horizontal wells waiting to be produced, and 2 vertical wells which will be used for pressure observation purposed within an area covering the south half of Section 20-008-28W1M (Figure 2). A project area well list complete with recent production statistics is attached as Table 3.

Within the proposed Unit, potential exists for incremental production and reserves from a Waterflood EOR project in the Lodgepole oil reservoir.

Geology

Stratigraphy:

The proposed Ewart Unit No. 12 (Appendix 1) is located on the carbonate slope of the Mississippian Lodgepole Formation on the Eastern edge of the Williston Basin. The stratigraphy of the reservoir section in Ewart Unit #12 is shown in the structural cross section (Appendix 2). The cross section A – A' runs from West to East through the proposed unit.

The Lodgepole section is subdivided into 7 units. In ascending order these are: the Basal Lodgepole Limestone, the Cromer Shale, the Cruickshank Crinoidal, the Cruickshank Shale, the Middle Daly, the Upper Daly and the Unnamed. A Dolomitic facies is prevalent over the Daly Sinclair area and is predominantly in the Unnamed, however can extend as deep as the Middle Daly formation. Of the seven members, only the Dolomite facies is productive, the lower limestone units are considered non-reservoir. All of the Mississippian horizontal wells in the proposed unit area are drilled and completed in the Lodgepole Dolomite facies.

The Triassic-Jurassic aged Watrous Red Beds Formation overlays the Lodgepole Formation and consists of red argillaceous siltstones and anhydrites which form an effective seal for the Lodgepole dolomite reservoir. The structural cross-section (Appendix 2) shows the correlations of the various units in the Lodgepole section as well as the overlying Watrous Red Beds and Watrous Evaporite.

Sedimentology:

The whole of the Lodgepole Formation in the Daly Sinclair area consists of an overall shallowing upward cycle which begins with the Upper Bakken transgressive cycle and continues to the Lodgepole Dolomite facies, which represents the shallowest part of the cycle preserved. The Unnamed unit (which is most often dolomitized) consists of a series of “brining upward” cycles, comprised of 1-2 m sequences that begin at an erosional base with coarser grained carbonate grainstones which rapidly grade upward into fine-grained dolomitic mudstones that characterize the bulk of the cycle. The dolomite facies contains anhydrite bands of variable thickness and disseminated anhydrite. The coarser grained grainstones at the base of each cycle generally consist of fossil fragments which are often replaced by chert or are tightly cemented. The fine grained dolomitic mudstones bear rare fossils, generally fragmental, consisting of bryozoans, corals, brachiopods and crinoids. The intimate association of the anhydrites with the dolomitized part of the Upper Lodgepole suggests dolomitization by seepage reflux with the magnesium rich brines provided

by the deposition of the anhydrites which cap each cycle. Other diagenetic processes include mobilization and re-precipitation of silica in the form of chert which is present in the form of nodules of massive, dense grey chert or as white “chalky” chert. The “chalky” chert can have considerable micro-porosity but is considered non-reservoir as these features are isolated and not connected to the main reservoir. The presence of the anhydrite beds within the Lodgepole Dolomite suggests deposition on the proximal part of a shallow carbonate ramp.

Reservoir development within the above mentioned cycles is largely due to secondary processes as most of the primary reservoir was likely cemented during deposition and early diagenesis. These secondary processes include: dolomitization, conversion of anhydrite to gypsum and leaching of fossils, grains and cements. These processes occurred while the Lodgepole was exhumed and eroded, but prior to deposition of the Watrous Red Beds.

The Lodgepole Limestone facies lies between the Cromer Shale and the Lodgepole Dolomite. Similar to the Dolomite facies, the Limestone facies displays evidence of cyclic deposition. The depositional cycles within the Limestone facies generally contain more grainstones at the base of each cycle and grade up into finer grained wackestones or mudstones. Grainstone beds, particularly the crinoidal grainstones, are frequently tightly cemented by chert. The lack of anhydrite beds and the presence of significantly more grainstones suggest deposition on a more distal and open marine part of the carbonate ramp than the overlying Lodgepole Dolomite facies. Within the Ewart Unit No. 12 area, the Lodgepole Limestone is considered non-reservoir.

The Cromer Shale is an argillaceous carbonate that appears as a higher gamma ray unit on logs and lies between the Lodgepole Limestone and the Basal Limestone. The Cromer Shale is considered non-reservoir.

The Basal Lodgepole Limestone lies between the Cromer Shale and the Upper Bakken Shale. Where cored, the Basal Limestone consists of a nodular lime mudstone to wackestone with numerous fossil fragments including crinoids, corals and brachiopods. The Basal Limestone is thought to represent deeper water conditions following the Upper Bakken transgression. The Basal Lodgepole Limestone is also considered non-reservoir.

An Isopach map is provided for the Lodgepole Dolomite facies as Appendix 3.

Structure:

A structure contour map is provided for the top of the Lodgepole Dolomite reservoir (Appendix 4). Structure on the top of the Lodgepole Formation reflects the erosional relief at the Mississippian Unconformity. A South West trending dip exists over the proposed unit. Structure descends to the East of the proposed unit, as you approach the edge of the Daly High, a paleo high associated with the Daly-Sinclair field.

Reservoir Quality:

Reservoir quality within the Lodgepole Dolomite facies is highly variable both laterally and vertically. Due to the heterolithic nature of the Lodgepole Dolomite reservoir and the inherent challenges in determining reservoir properties from petrophysical logs in carbonates, high resolution pressure-decay profile permeameter (PDPK) core data was used to determine an average net to gross ratio. A

permeability cutoff of 0.5 md was applied to differentiate reservoir from non-reservoir. The gross thickness of the Lodgepole Dolomite is represented by the Dolomite Isopach (Appendix 3). The top and base of the Lodgepole Dolomite facies was determined using openhole wireline logs. An average net to gross ratio, calculated to be 38.1%, was applied to the gross thickness of the Lodgepole Dolomite facies to determine a net pay thickness.

An average porosity value was derived from routine core analysis using a 0.5mD cutoff. The average porosity of net pay was calculated to be 12.5%.

Fluid Contacts:

No oil-water contact is found within the Lodgepole formation in the area local to the proposed unit.

OOIP Estimates

Total volumetric OOIP for the Dolomite facies within the proposed unit has been calculated to be 858.1 e³m³ (5,397 Mbbl). Tundra generated maps integrate both open hole wireline logs and core data when available. (Appendices 1-6).

OOIP values were calculated using the following volumetric equation:

$$OOIP = \frac{Area * Net Pay * Porosity * (1 - Water Saturation)}{Initial Formation Volume Factor of Oil}$$

or

$$OOIP(m^3) = \frac{A * h * \phi * (1 - Sw)}{Bo} * \frac{10,000m^2}{ha}$$

or

$$OOIP(Mbbl) = \frac{A * h * \phi * (1 - Sw)}{Bo} * 3.28084 \frac{ft}{m} * 7,758.367 \frac{bbl}{acre * ft} * \frac{1Mbbl}{1,000bbl}$$

where

OOIP	=Original Oil in Place by LSD	= 5,397 Mbbl (total)
A	=Area	= 40 acres/LSD
h * ϕ	=Net Pay * Porosity, or Phi * h	= 12.5% * 38.1% * Dolo Gross h(m)
Bo	=Formation Volume Factor of Oil	= 1.1 stb/rb
Sw	=Water Saturation	= 25%

The initial oil formation volume factor (Boi) was adopted from historical PVT information taken from the Sinclair Daly area and is representative of the fluid characteristics in the reservoir.

Historical Production

A historical group production plot for the proposed Ewart Unit No. 12 is shown as Figure 4. The oil production rate in the Ewart Unit No. 12 area peaked during April 2014 at 39.8 m³ (259 bbl) of oil per day (OPD) when developed with horizontal wells at 400m inter-well spacing. As of August 2016, production was 9.78 m³ (61.6 bbl) OPD, 0.92 m³ (5.8 bbl) water per day (WPD) and an 8.6% water cut (WCUT).

From peak production in April 2014 to date, oil production is declining at an annual rate of approximately 17% under the current Primary Production method.

The remainder of the field's production and decline rates indicate the need for pressure restoration and maintenance. Waterflooding is deemed to be the most efficient means of secondary recovery to introduce energy back into the system and provide areal sweep between wells.

UNITIZATION

Unitization and implementation of a Waterflood EOR project is forecasted to increase overall recovery of OOIP from the proposed project area by 35% (from a recovery factor of 10.5% to 14.8%). The basis for unitization is to develop the lands in an effective manner that will be conducive to waterflooding. Unitizing will enable the reservoir to have a higher recovery of oil by allowing the development of additional drilling and injector conversions over time. In addition, Unitizing will facilitate a pressure maintenance scheme, and overall will increase oil production over time.

Unit Name

Tundra proposes that the official name of the new Unit shall be Ewart Unit No. 12.

Unit Operator

Tundra Oil and Gas Partnership (Tundra) will be the Operator of record for Ewart Unit No. 12.

Unitized Zone

The unitized zone(s) to be waterflooded in Ewart Unit No. 12 will be the Lodgepole formation.

Unit Wells

The 5 wells to be included in the proposed Ewart Unit No. 12 are outlined in Table 3.

Unit Lands

Ewart Unit No. 12 will consist of 8 LSDs as follows:

S/2 Section 20, of Township 8, Range 28, W1M

The lands included in the 40 acre tracts are outlined in Table 1.

Tract Factors

The Tract Factor contribution for each of the LSD's within the proposed Ewart Unit No. 12 was calculated as follows:

- OOIP by LSD, minus cumulative production to date for the LSD as distributed by the LSD specific Production Allocation (PA) % in the applicable producing horizontal well (to yield Remaining OOIP)
- Tract Factor by LSD = The product of Remaining OOIP by LSD as a % of total proposed Unit Remaining OOIP

Tract Factor calculations for all individual LSD's based on the above methodology are outlined within Table 2.

Working Interest Owners

Table 1 outlines the working interest % (WI) for each recommended Tract within the proposed Ewart Unit No. 12.

Tundra Oil and Gas Partnership will have a 100% working interest in the proposed Ewart Unit No. 12.

WATERFLOOD EOR DEVELOPMENT

The waterflood performance predictions for the proposed Ewart Unit No. 12 Lodgepole project are based on internal engineering assessments. Project area specific reservoir and geological parameters were used to guide the overall Secondary Waterflood recovery factor.

Based on the geological descriptions, primary production decline rate, and positive waterflood response in the analog Clearfork formation in the Permian Basin of West Texas, the Lodgepole formation in the project area is deemed to be a suitable trial for waterflood EOR operations.

Pre-Production of New Horizontal Injection Wells

Two (2) of the existing producing horizontal wells and one (1) of the recently drilled horizontal wells will be converted to horizontal injection wells as shown in Figure 5. This will result in 100m Horizontal to Horizontal waterflood patterns within Ewart Unit No. 12.

Placing new horizontal wells immediately on water injection in areas without significant reservoir pressure depletion has been problematic in similar low permeability formations, and has a negative impact on the ultimate total recovery factor of OOIP. Considering the expected reservoir pressures and reservoir lithology described, Tundra believes an initial period of producing horizontal wells prior to placing them on permanent water injection is essential and all Unit mineral owners will benefit.

Tundra monitors reservoir pressure, fluid production and decline rates in each pattern to determine when the well will be converted to water injection.

Reserves Recovery Profiles and Production Forecasts

The primary waterflood performance predictions for the proposed Ewart Unit No. 12 are based on oil production decline curve analysis, and the secondary predictions are based on internal engineering analysis performed by the Tundra reservoir engineering group using numerical simulation in combination with analogue studies of successful waterfloods in the Clearfork formation.

Primary Production Forecast

Cumulative production to the end of August 2016 from the 2 producing Lodgepole wells within the proposed Ewart Unit No. 12 project area is 15.78 e³m³ of oil and 2.37 e³m³ of water for a recovery factor of 1.8% of the total OOIP.

Based on decline curve analysis of the wells currently on production, the estimated ultimate recovery (EUR) for the proposed Unit with no further development is estimated to be 42.98 e³m³, representing a recovery factor of **5.0%** of the total OOIP (Figures 6 & 7).

Recently drilled 3 infill horizontal wells at 100m inter-well spacing is estimated to increase the estimated ultimate recovery (EUR) for the proposed unit to 89.7 e³m³, representing a primary recovery factor of **10.5%** of the total OOIP.

Production plots of the forecasted oil rate v. time and oil rate v. cumulative oil produced are shown in Figures 8 & 9, respectively.

Pre-Production Schedule/Timing for Conversion of Horizontal Wells to Water Injection

Tundra will plan an injection conversion schedule to allow for the most expeditious development of the waterflood within the proposed Ewart Unit No. 12, while maximizing reservoir knowledge.

Criteria for Conversion to Water Injection Well

Three (3) water injection wells are required for this proposed unit as shown in Figure 5.

Tundra will monitor the following parameters to assess the best timing for each individual horizontal well to be converted from primary production to water injection service.

- Measured reservoir pressures at start of and/or through primary production
- Fluid production rates and any changes in decline rate
- Any observed production interference effects with adjacent wells
- Pattern mass balance and/or oil recovery factor estimates
- Reservoir pressure relative to bubble point pressure

The above schedule allows for the proposed Ewart Unit No. 12 project to be developed equitably, efficiently, and moves the project to the best condition for the start of waterflood as quickly as possible. It also provides the Unit Operator flexibility to manage the reservoir conditions and response to help ensure maximum ultimate recovery of OOIP.

Secondary EOR Production Forecast

The proposed Ewart Unit No. 12 Secondary Waterflood oil production forecast over time is plotted on Figure 10. Total EOR recoverable volumes in the proposed Ewart Unit No. 12 project under Secondary WF has been estimated at 126.8 e³m³, resulting in a **14.8%** overall RF of calculated Net OOIP.

An incremental 37.0 e³m³ of oil is forecast to be recovered under the proposed Unitization and Secondary EOR production scheme vs. the Primary Production method. This relates to an incremental **4.3%** recovery factor as a result of secondary EOR implementation.

Estimated Fracture Pressure

The estimated fracture gradient for the Lodgepole is 21 kPa/m based on DFIT ISIP data in the area. The horizontal wells in this area are ~ 790mTVD. Therefore, the estimated frac pressure would be 16.6MPa.

WATERFLOOD OPERATING STRATEGY

Water Source

The injection water for the proposed Ewart Unit No. 12 will be supplied from the existing source and injection water system at the Sinclair 04-01-008-29 Water Filtration Plant. All existing injection water is obtained from the Mannville formation in the 102/14-30-007-28W1 licensed water source well. Mannville water from the 102/14-30 source well is pumped to the main Water Plant at 4-1-8-29W1, filtered, and pumped up to injection system pressure. A diagram of the Daly Sinclair water injection system and new pipeline connection to the proposed Ewart Unit No. 12 project area is shown as Figure 12.

Produced water is not currently used for any water injection in the Tundra-operated Daly Sinclair Units and there are no plans to use produced water as a source supply for Ewart Unit No. 12.

Injection Wells

The water injection wells for the proposed Ewart Unit No. 12 have been drilled, are currently producing and plans are in progress to re-configure the wells for downhole injection after approval for waterflood has been received (Figure 13). The horizontal injection wells have been stimulated by multiple hydraulic fracture treatments to obtain suitable injection. Tundra has extensive experience with horizontal fracturing in the area, and all jobs are rigorously programmed and monitored during execution. This helps ensure optimum placement of each fracture stage to prevent, or minimize, the potential for out-of-zone fracture growth and thereby limit the potential for future out-of-zone injection.

The new water injection well will be placed on injection after the pre-production period and approval to inject. Wellhead injection pressures will be maintained below the least value of either:

1. the area specific known and calculated fracture gradient, or
2. the licensed surface injection Maximum Allowable Pressure (MOP).

Tundra has a thorough understanding of area fracture gradients. A management program will be implemented to set and routinely review injection target rates and pressures vs. surface MOP and the known area formation fracture pressures.

All new water injection wells will be surface equipped with injection volume metering and rate/pressure control. An operating procedure for monitoring water injection volumes and meter balancing will also be utilized to monitor the entire system measurement and integrity on a daily basis.

The proposed Ewart Unit No. 12 horizontal water injection well rate is estimated to average 10 – 25 m³ WPD, based on expected reservoir permeability and pressure.

Reservoir Pressure

No recent or representative initial pressure surveys are available for the proposed Ewart Unit No. 12 project area in the Lodgepole producing zone.

Initial reservoir pressure measurements for the infill wells are planned and underway. These pressures along with any subsequent pressures will be submitted in the annual progress reports.

Reservoir Pressure Management during Waterflood

Tundra expects to inject water for a minimum 2 – 4 year period to re-pressurize the reservoir due to cumulative primary production voidage and pressure depletion. Initial Voidage Replacement Ratio (VRR) is expected to be approximately 1.25 to 1.75 within the pattern during the fill up period. As the cumulative VRR approaches 1, target reservoir operating pressure for waterflood operations will be 75 – 90 % of original reservoir pressure.

Waterflood Surveillance and Optimization

Ewart Unit No. 12 EOR response and waterflood surveillance will consist of the following:

- Regular production well rate and WCT testing
- Daily water injection rate and pressure monitoring vs target
- Water injection rate / pressure / time vs cumulative injection plot
- Reservoir pressure surveys as required to establish pressure trends
- Pattern VRR
- Potential use of chemical tracers to track water injector / producer responses
- Use of some or all of: Water Oil Ratio (WOR) trends, Log WOR vs Cum Oil, Hydrocarbon Pore Volumes Injected, Conformance Plots

The above surveillance methods will provide an ever increasing understanding of reservoir performance, and provide data to continually control and optimize the Ewart Unit No. 12 waterflood operation. Controlling the waterflood operation will significantly reduce or eliminate the potential for out-of-zone injection, undesired channeling or water breakthrough, or out-of-Unit migration. The monitoring and surveillance will also provide early indicators of any such issues so that waterflood operations may be altered to maximize ultimate secondary reserves recovery from the proposed Ewart Unit No. 12.

Economic Limits

Under the current Primary recovery method, existing wells within the proposed Ewart Unit No. 12 will be deemed uneconomic when the net oil rate and net oil price revenue stream becomes less than the current producing operating costs. With any positive oil production response under the proposed Secondary recovery method, the economic limit will be significantly pushed out into the future. The actual economic cut off point will then again be a function of net oil price, the magnitude and duration of production rate response to the waterflood, and then current operating costs. Waterflood projects generally become uneconomic to operate when Water Oil Ratios (WOR's) exceed 100.

WATER INJECTION FACILITIES

The Ewart Unit No. 12 waterflood operation will utilize the existing Tundra operated source well supply and water plant (WP) facilities located at 4-1-8-29 W1M Battery. Injection wells will be connected to the existing high pressure water pipeline system supplying other Tundra-operated Waterflood Units.

A complete description of all planned system design and operational practices to prevent corrosion related failures is shown on Figure 14.

NOTIFICATION OF MINERAL AND SURFACE RIGHTS OWNERS

Tundra will notify all mineral rights and surface rights owners of the proposed EOR project and formation of Ewart Unit No. 12. Copies of the Notices, and proof of service, to all surface rights owners will be forwarded to the Petroleum Branch when available to complete the Ewart Unit No. 12 Application.

Ewart Unit No. 12 Unitization, and execution of the formal Ewart Unit No. 12 Agreement by affected Mineral Owners, is expected during Q4 2016. Copies of same will be forwarded to the Petroleum Branch, when available, to complete the Ewart Unit No. 12 Application.

Should the Petroleum Branch have further questions or require more information, please contact Abhy Pandey at 403.767.1247 or by email at abhy.pandey@tundraoilandgas.com.

TUNDRA OIL & GAS PARTNERSHIP

Original Signed by Abhy Pandey, December 5th, 2016, in Calgary, AB

Proposed Ewart Unit No. 12
Application for Enhanced Oil Recovery Waterflood Project

List of Figures

Figure 1	Daly Sinclair Field Map
Figure 2	Ewart Unit No. 12 Proposed Boundary
Figure 3	Lodgepole Pool Boundaries
Figure 4	Ewart Unit No. 12 Historical Production
Figure 5	Ewart Unit No. 12 Proposed Injectors
Figure 6	Ewart Unit No. 12 Primary Recovery – Rate vs. Time
Figure 7	Ewart Unit No. 12 Primary Recovery – Rate vs. Cumulative Oil
Figure 8	Ewart Unit No. 12 Primary Recovery with 3 Infill Wells – Rate vs. Time
Figure 9	Ewart Unit No. 12 Primary Recovery with 3 Infill wells – Rate vs. Cumulative Oil
Figure 10	Ewart Unit No. 12 Waterflood with 3 Infill Wells – Rate vs. Time
Figure 11	Ewart Unit No. 12 Waterflood with 3 Infill Wells – Rate vs. Cumulative Oil
Figure 12	Ewart Unit No. 12 Injection Facilities Process Flow Diagram
Figure 13	Typical Injector Downhole Schematic
Figure 14	Corrosion Control

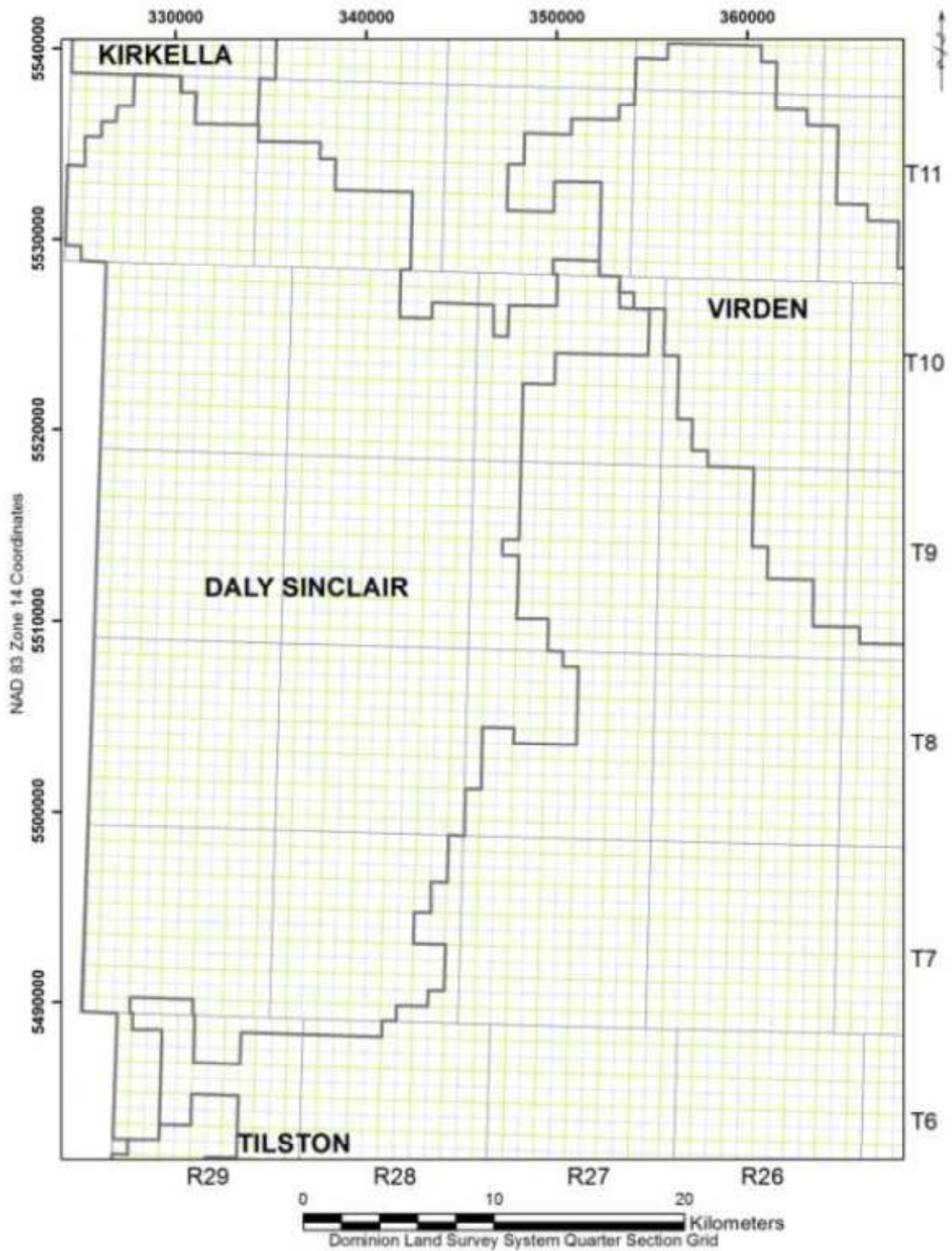
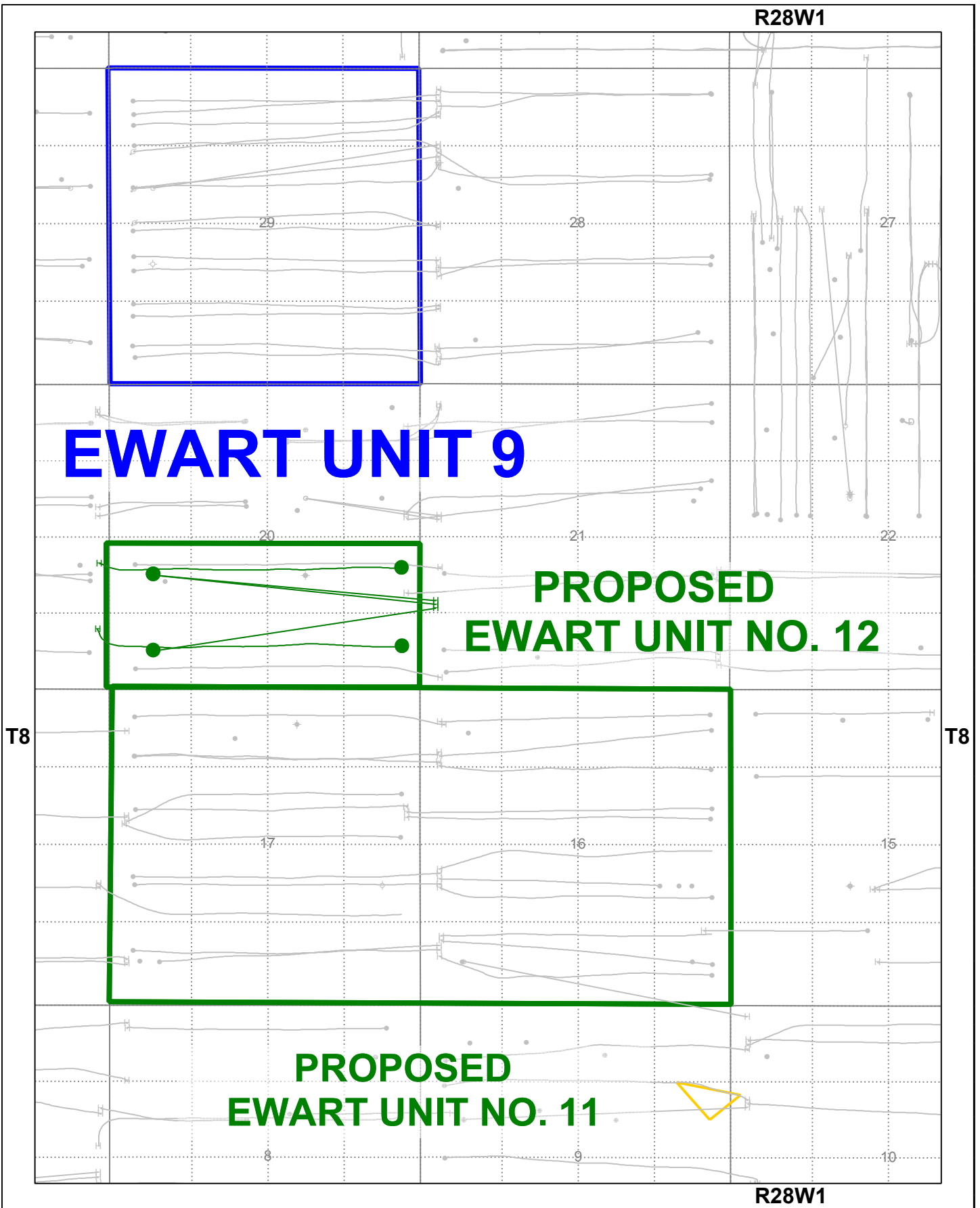

Figure 2 - Daly Sinclair (01)



Datum: NAD27 Projection: Stereographic DLS Version AB: ATS 2.6, BC: PRB 2.0, SK: STS 2.5, MB: MLI07



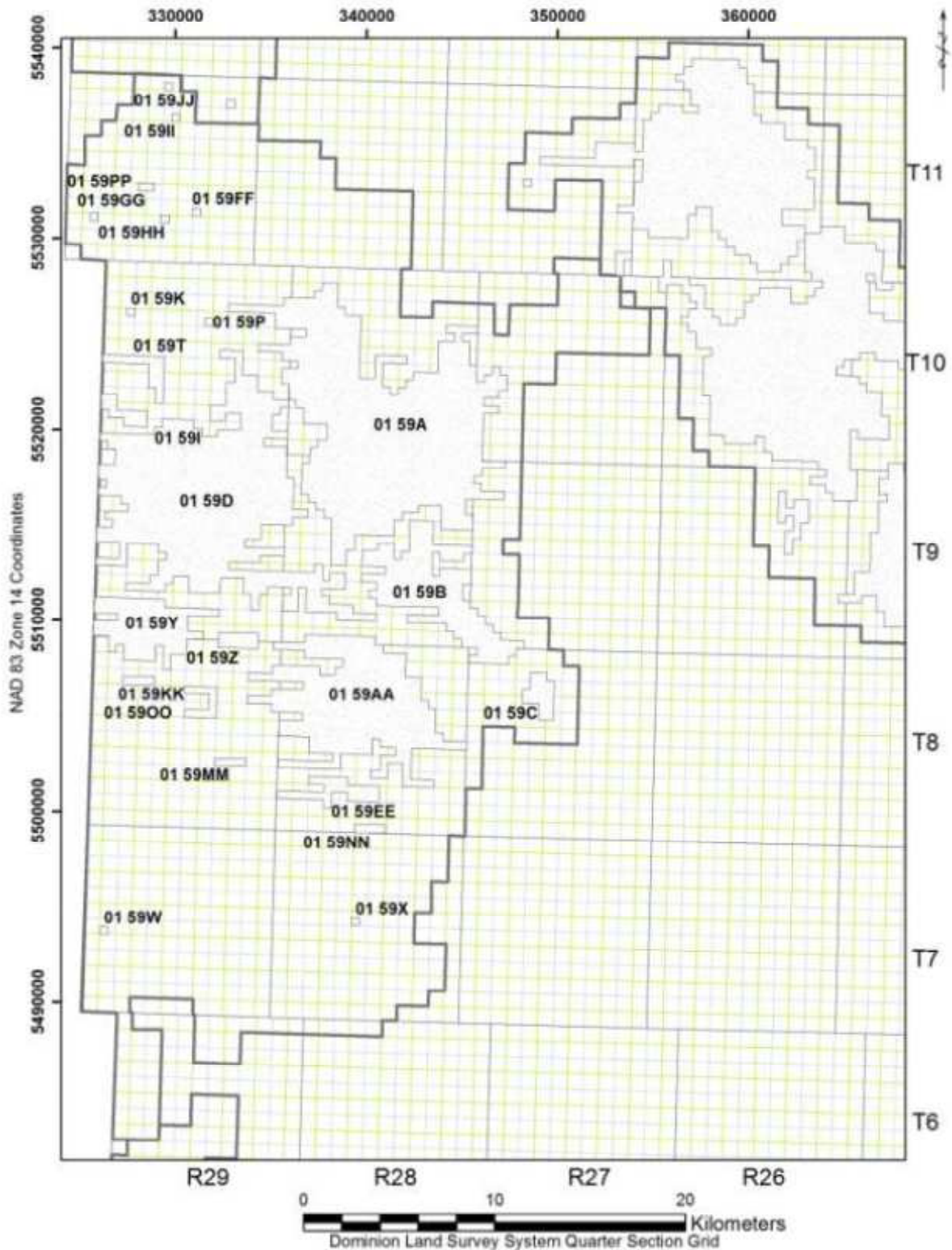

Figure 12 - Daly Sinclair Lodgepole Pools (01 59A, B, C, D, I, K, P, T, W, X, Y, Z, AA, EE, FF, GG, HH, II, JJ, KK, MM, NN, OO & PP)

Well Information as of 10/6/2016 - Group Well Report

Production Graph

Group:	ewart unit 12 well list.lwell	On Prod:	2014-03 to 2016-07	Cum Oil:	15478.2 m3
# of Wells:	5	Prod Form:	LODGEPOL	Cum Gas:	0.0 E3m3
Fluid:	Oil	Field:	DALY (1)	Cum Wtr:	2340.2 m3
Mode:	Producing	Pool Code:	59A	Cum Inj Oil:	0.0 m3
		Unit Code:		Cum Inj Gas:	0.0 E3m3
				Cum Inj Wtr:	0.0 m3

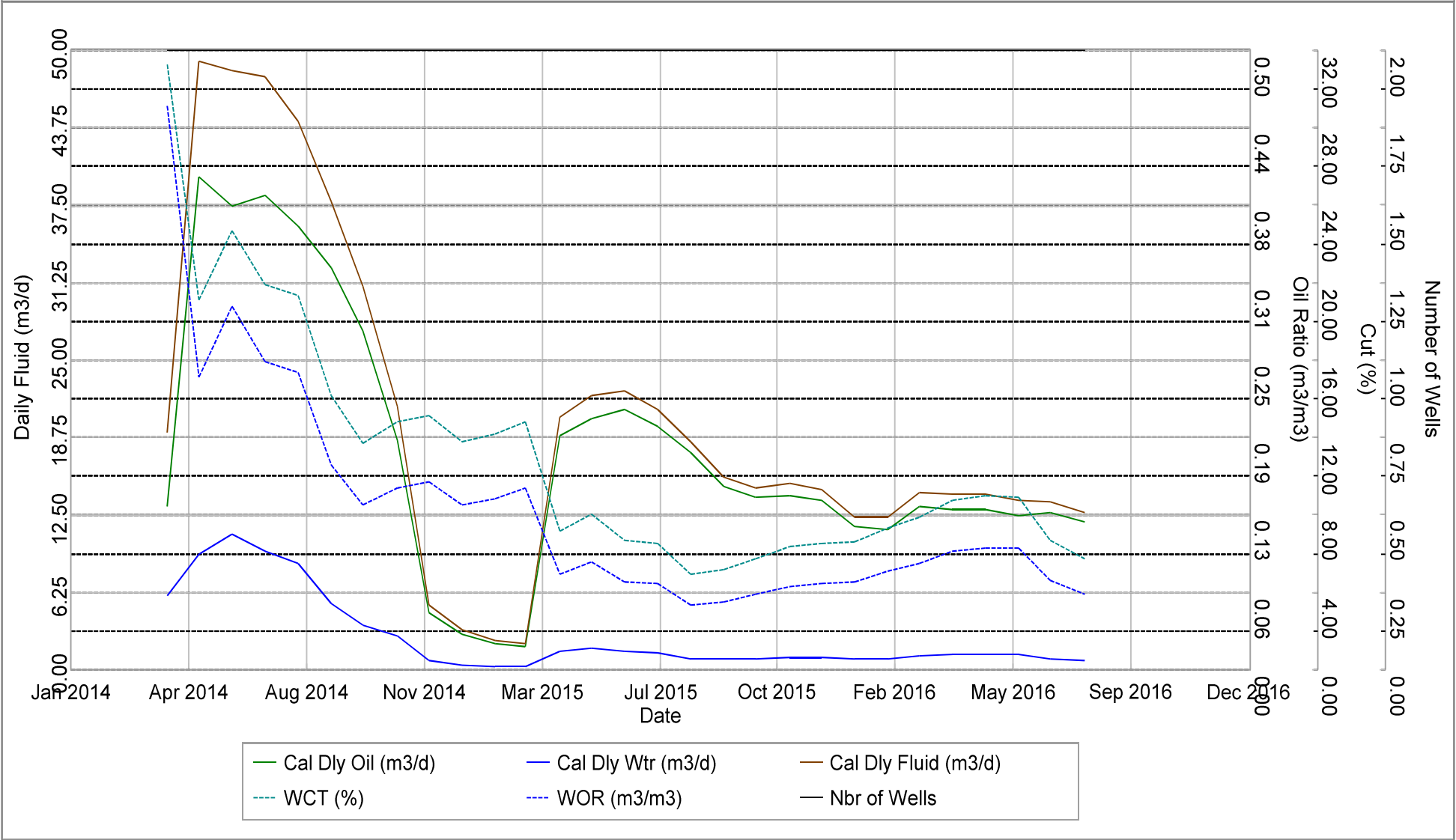
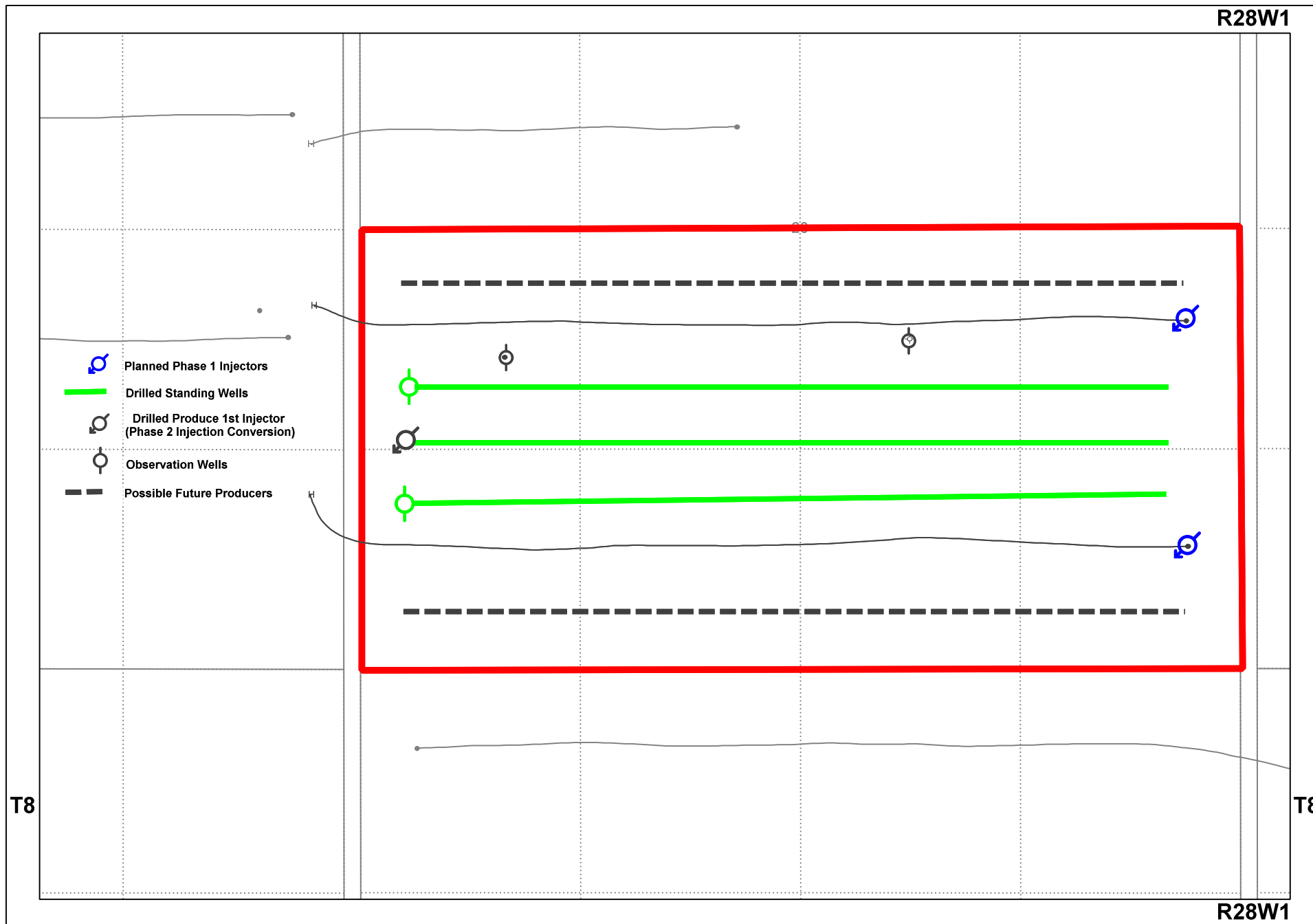

Figure No. 5

R28W1



Primary Recovery

Figure No. 6

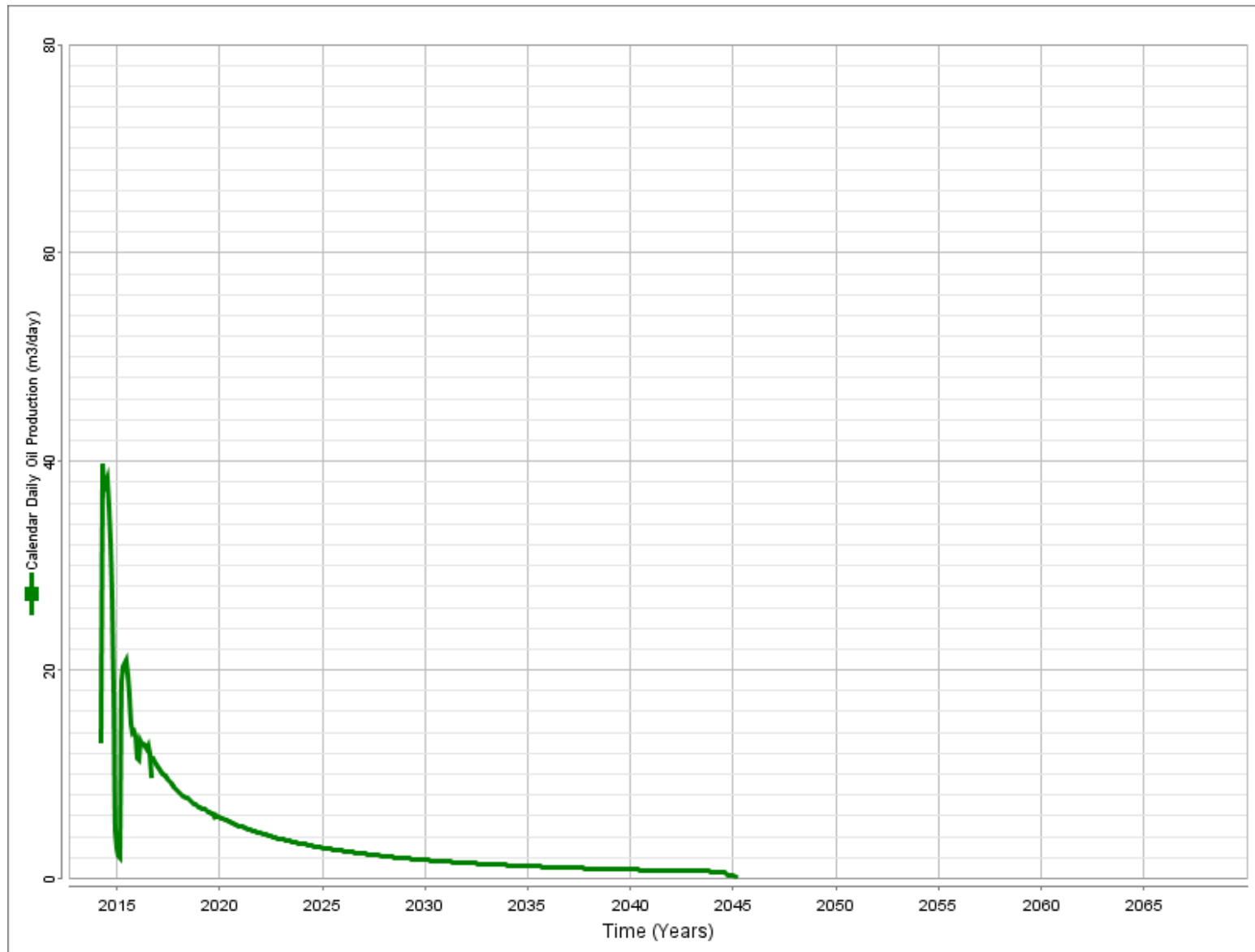

Primary Recovery

Figure No. 7

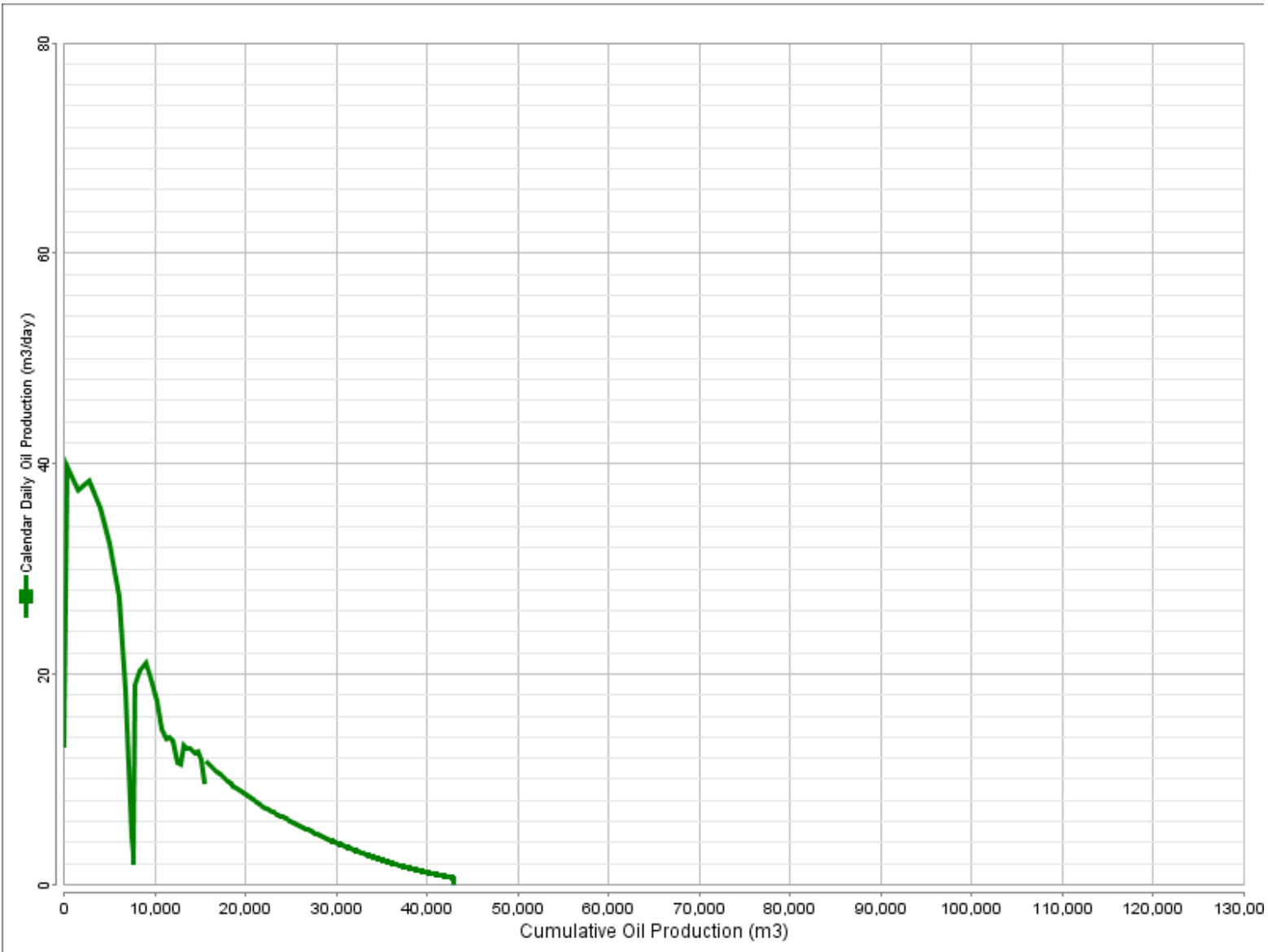

Primary Recovery + 3 Infill Wells

Figure No. 8

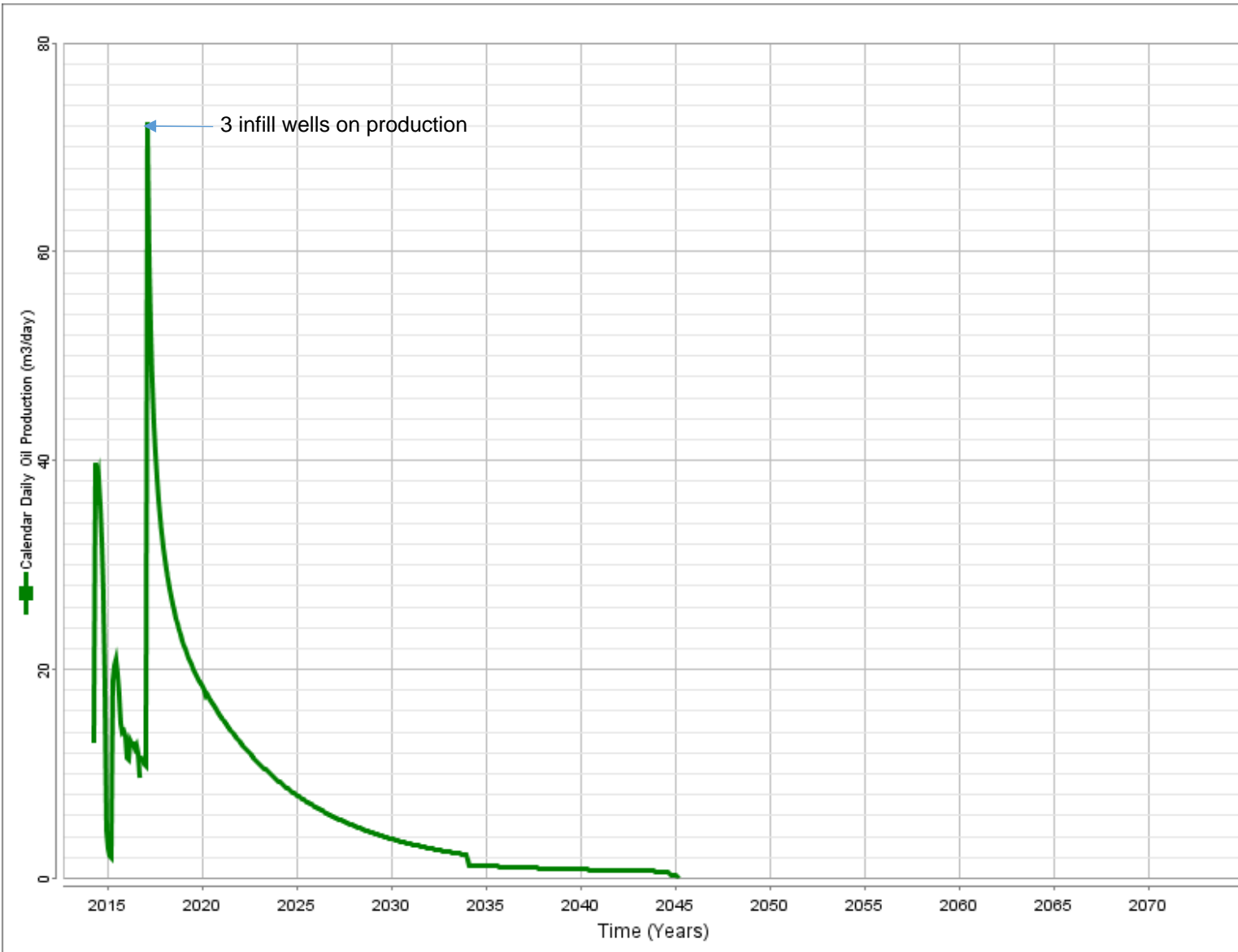

Primary Recovery + 3 Infill Wells

Figure No. 9

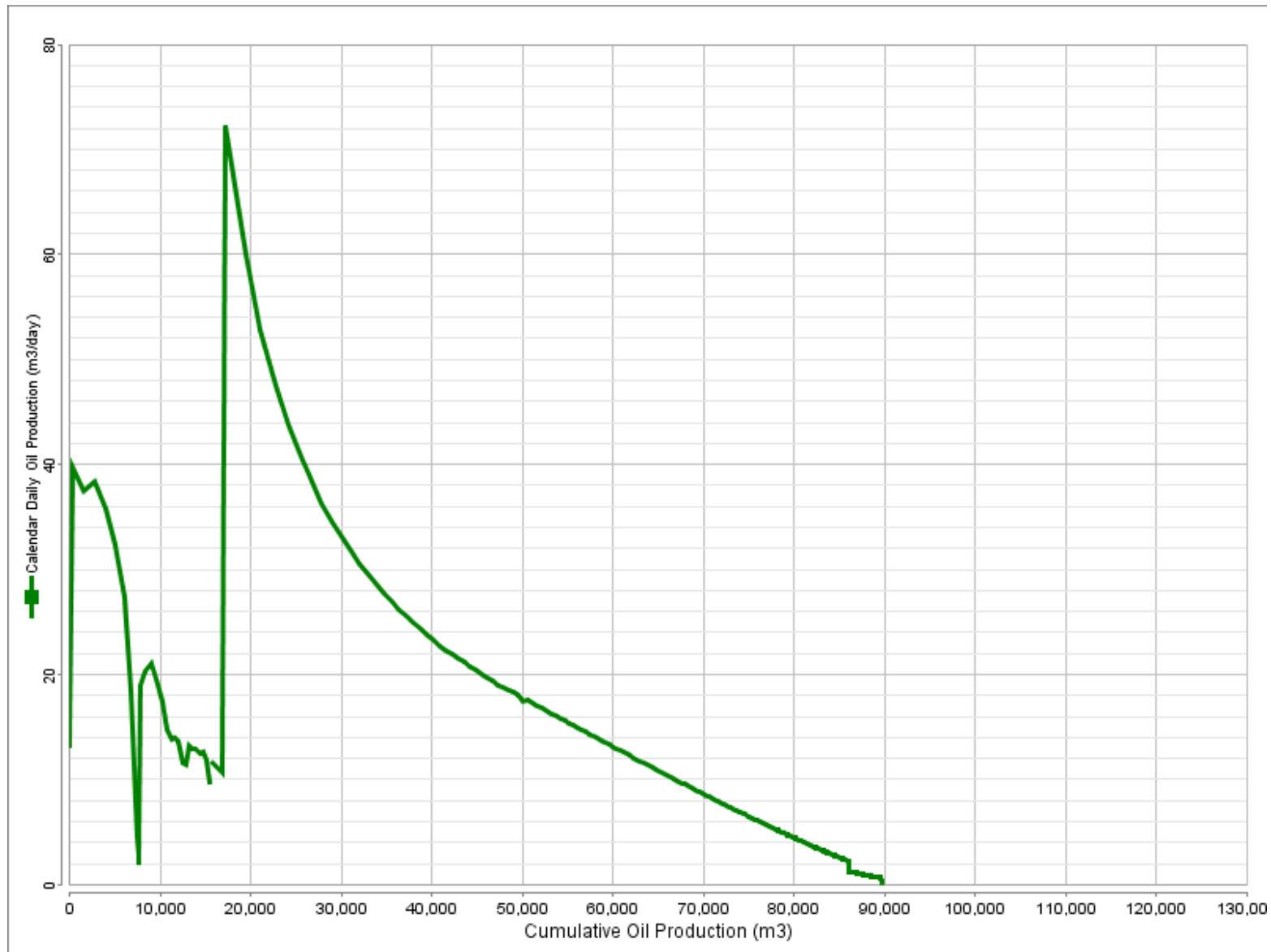

Waterflood + 3 Infill Wells

Figure No. 10

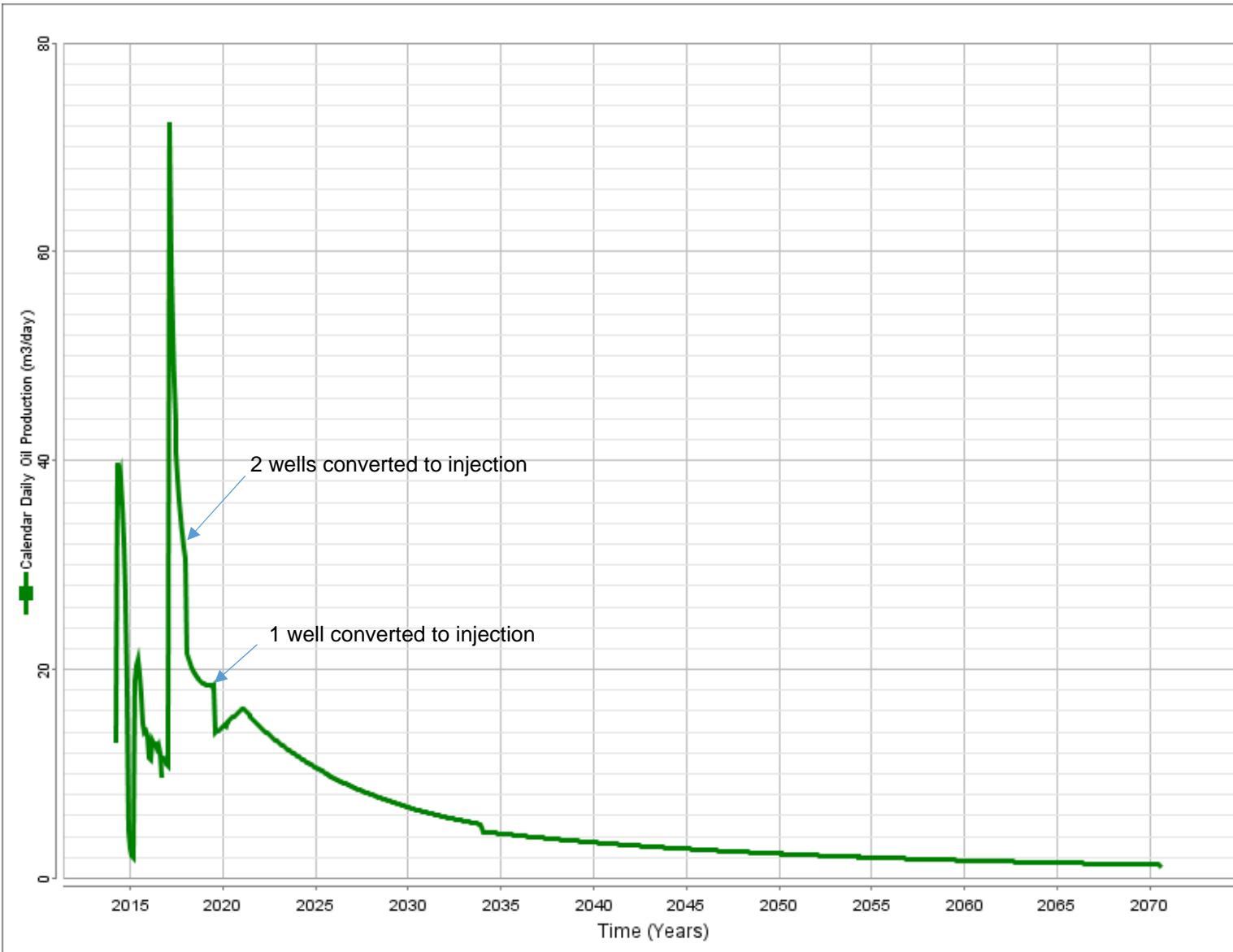

Waterflood + 3 Infill Wells

Figure No. 11

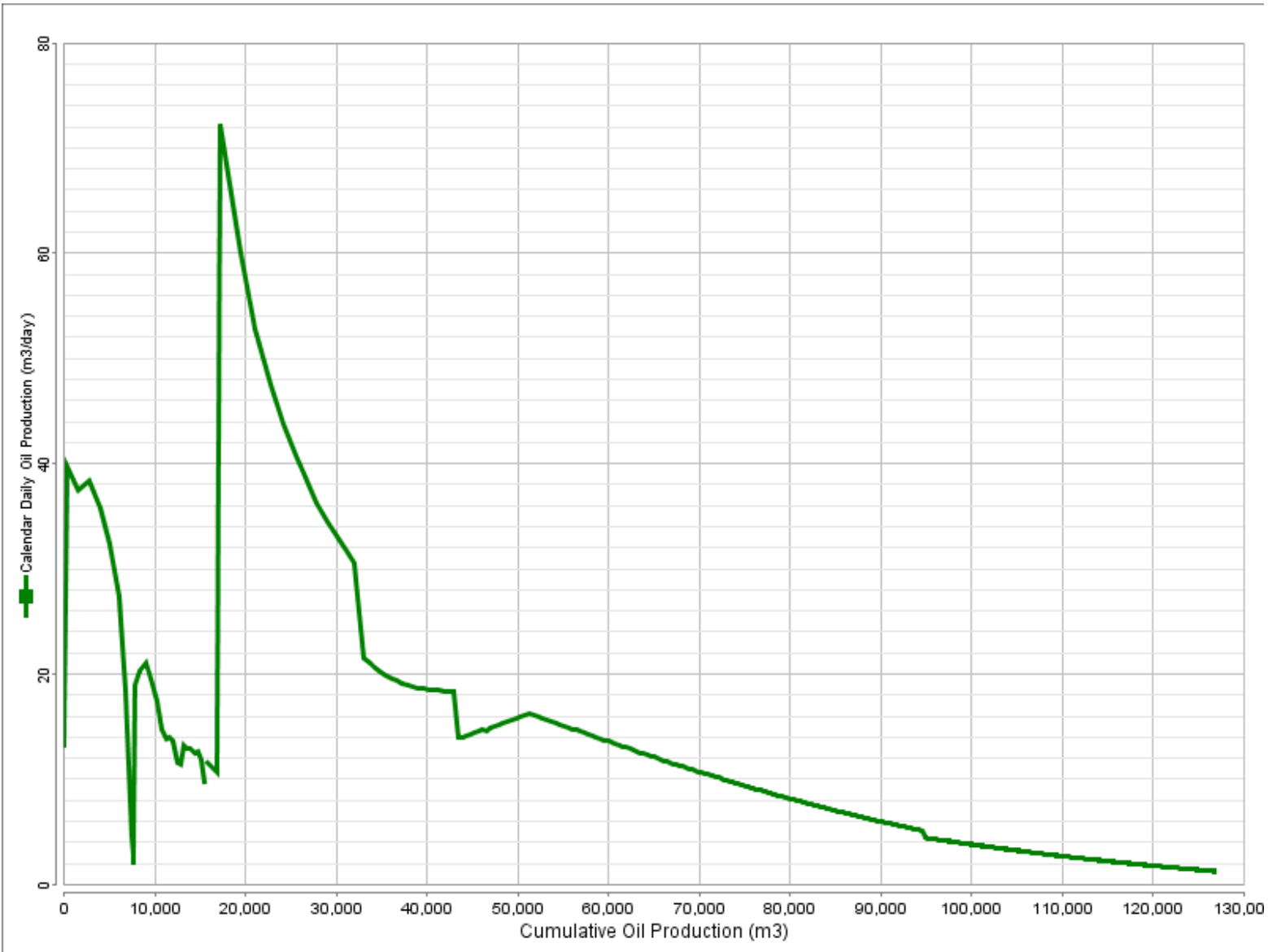
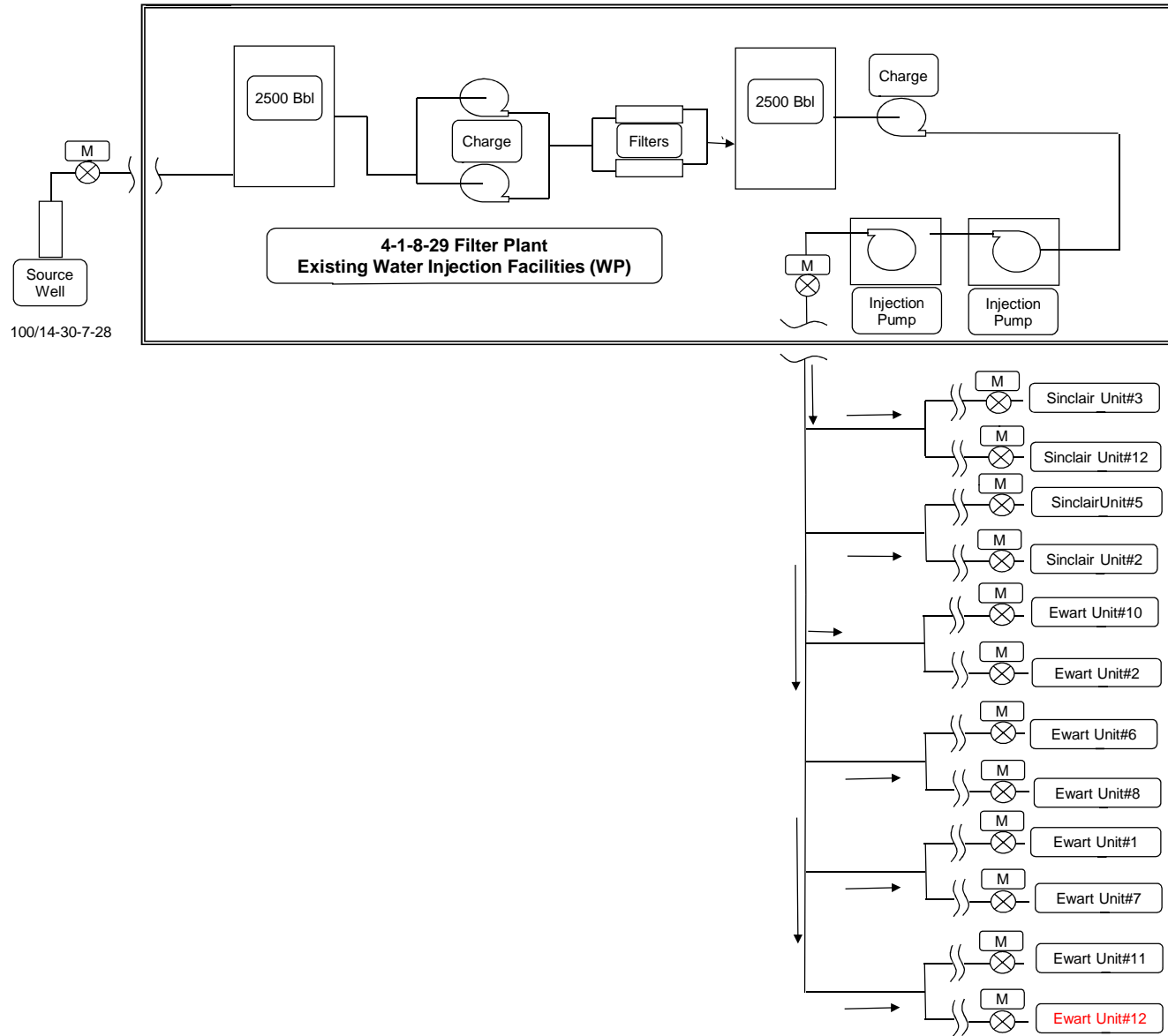
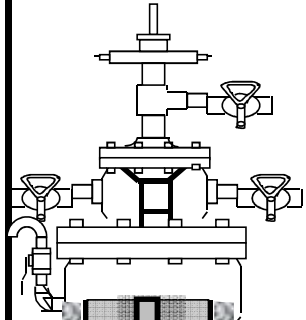

FIGURE NO. 12

Sinclair Water Injection System



TYPICAL CEMENTED LINER WATER INJECTION WELL (WIW) DOWNHOLE DIAGRAM



WELL NAME: Tundra Ewart Unit 12 HZNTL Cemented Liner WIW				WELL LICENCE:	
Prepared by CP (average depths)			Date: 2016		
Elevations :					
KB [m]		KB to THF [m]		TD [m]	2400.0
GL [m]		CF (m)		PBTD [m]	
Current Perfs:	Cemented Casing / Liner		950.0	to	2400.0
Current Perfs:				to	
KOP:	600 m MD		Total Interval		to
Tubulars	Size [mm]	Wt - Kg/m	Grade	Landing Depth [mKB]	
Surface Casing	244.5	48.06	H-40 - ST&C	Surface	to 140.0
Intermed Csg (if run)	139.7	34.23 & 29.76	J-55 - LT&C	Surface	to 900.0
Production Liner	114.3	17.26	L-80	Surf or from Intermed Csg to 2400.0	
Tubing	60.3 or 73.0 - TK-99	6.99 or 9.67	J-55	Surface	to 900.0
Date of Tubing Installation:					
Item	Description	K.B.--Tbg. Fig.	Length 0.00	Top @ m KB	
	Corrosion Protected ENC Coated Packer (set near TD of intermediate casing, if run)				
	60.3 mm or 73 mm TK-99 Internally Coated Tubing				
	TK-99 Internally Coated Tubing Pup Jt				
	Coated Split Dognut				
	Annular space above injection packer filled with inhibited fresh water				
Bottom of Tubing mKB					
Rod String :					
Date of Rod Installation:					
Bottomhole Pump:					
Directions:					

SC = 140mKB

KOP = ~ 600 mMD

Inhibited Annular Fluid

Packer set near TD of intermediate casing)

Tubing bottom

Hz Lateral 114.3 mm Casing Liner

Fractures

Cement

Intermediate Casing, if run

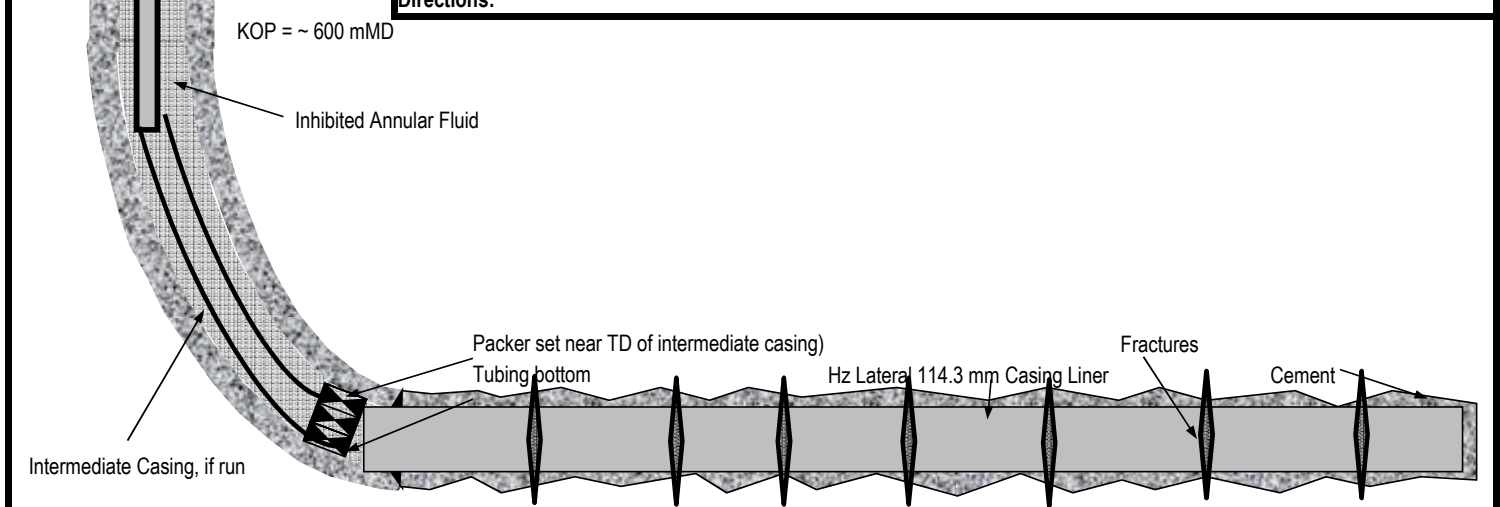

Ewart Unit No. 12

EOR Waterflood Project

Planned Corrosion Control Program **

Source Well

- Continuous downhole corrosion inhibition
- Continuous surface corrosion inhibitor injection
- Downhole scale inhibitor injection
- Corrosion resistant valves and internally coated surface piping

Pipelines

- Source well to 4-1-8-29 Water Plant - Fiberglass
- New High Pressure Pipeline to injection well – 2000 psi high pressure Fiberglass

Facilities

- 4-1-8-29 Water Plant and New Injection Pump Station
 - Plant piping – 600 ANSI schedule 80 pipe, Fiberglass or Internally coated
 - Filtration – Stainless steel, HDPE Poly, fiberglass materials
 - Pumping – Ceramic plungers, stainless steel disc valves
 - Tanks – Fiberglass shell, corrosion resistant valves

Injection Wellhead / Surface Piping

- Corrosion resistant valves and internally coated surface piping

Injection Well

- Casing cathodic protection where required
- Wetted surfaces coated downhole packer
- Corrosion inhibited water in the annulus between tubing / casing
- Internally coated tubing surface to packer
- Surface freeze protection of annular fluid
- Corrosion resistant master valve
- Corrosion resistant pipeline valve

Producing Wells

- Casing cathodic protection where required
- Downhole batch corrosion inhibition as required
- Downhole scale inhibitor injection as required

FIGURE 14

** subject to final design and engineering

Proposed Ewart Unit No. 12

Application for Enhanced Oil Recovery Waterflood Project

List of Tables

Table 1	Land Information and Tract Participation
Table 2	Original Oil in Place and Recovery Factors
Table 3	Current Well List and Status
Table 4	Original Oil in Place

TABLE NO. 1: TRACT PARTICIPATION FOR PROPOSED EWART UNIT NO. 12

Tract No.	Working Interest			Royalty Interest			Tract Participation (%)
	Land Description	Owner	Share (%)	Owner	Share (%)	Share (%)	
1	01-20-008-28W1M	Tundra Oil & Gas Partnership	100%	Minister of Finance - Manitoba	100.000%	11.877463774	
2	02-20-008-28W1M	Tundra Oil & Gas Partnership	100%	Minister of Finance - Manitoba	100.000%	11.518059094	
3	03-20-008-28W1M	Tundra Oil & Gas Partnership	100%	Minister of Finance - Manitoba	100.000%	12.625570320	
4	04-20-008-28W1M	Tundra Oil & Gas Partnership	100%	Minister of Finance - Manitoba	100.000%	13.819241056	
5	05-20-008-28W1M	Tundra Oil & Gas Partnership	100%	Minister of Finance - Manitoba	100.000%	14.905178046	
6	06-20-008-28W1M	Tundra Oil & Gas Partnership	100%	Minister of Finance - Manitoba	100.000%	12.874692701	
7	07-20-008-28W1M	Tundra Oil & Gas Partnership	100%	Minister of Finance - Manitoba	100.000%	11.036240953	
8	08-20-008-28W1M	Tundra Oil & Gas Partnership	100%	Minister of Finance - Manitoba	100.000%	11.343554058	

100.000000000

TABLE NO. 2: TRACT FACTOR CALCULATIONS
TRACT FACTORS BASED ON OIL-IN-PLACE (OOIP) LESS CUMULATIVE OIL PRODUCED METHOD

PROPOSED EWART UNIT NO. 12

LSD-SEC	TWP-RGE	UWI	OOIP (m3)	Hz Allocated Cum Prodn August 2016 (m3)	OOIP - Cum Oil Prodn (m3)	Tract Factor (%)	UWI
01-20	008-28W1M	100/01-20-008-28W1M	101,996	1951.2	100,044	11.877463774	100/01-20-008-28W1M
02-20	008-28W1M	100/02-20-008-28W1M	99,053	2035.9	97,017	11.518059094	100/02-20-008-28W1M
03-20	008-28W1M	100/03-20-008-28W1M	108,380	2034.7	106,346	12.625570320	100/03-20-008-28W1M
04-20	008-28W1M	100/04-20-008-28W1M	118,129	1728.5	116,400	13.819241056	100/04-20-008-28W1M
05-20	008-28W1M	100/05-20-008-28W1M	127,403	1855.8	125,547	14.905178046	100/05-20-008-28W1M
06-20	008-28W1M	100/06-20-008-28W1M	110,537	2092.6	108,444	12.874692701	100/06-20-008-28W1M
07-20	008-28W1M	100/07-20-008-28W1M	95,052	2093.0	92,959	11.036240953	100/07-20-008-28W1M
08-20	008-28W1M	100/08-20-008-28W1M	97,537	1989.9	95,547	11.343554058	100/08-20-008-28W1M
			858,086	15781.5	842,305	100.000000000	

TABLE NO. 3

Proposed Ewart Unit 12 Well List

UWI	License Number	Rig Release Date	Type	Pool Name	Producing Zone	Mode	On Prod Date	Prod Date	Cal Dly Oil (m3/d)	Monthly Oil (m3)	Cum Prd Oil (m3)	Cal Dly Water (m3/d)	Monthly Water (m3)	Cum Prd Water (m3)	WCT (%)
100/01-20-008-28W1/0	009805	2/26/2014	Horizontal	LODGEPOLE A	LODGEPOL	Producing	3/16/2014	Aug-2016	6.5	200.4	7750.3	0.8	24.3	1461.6	10.81
102/04-20-008-28W1/0	010561	N/A	Horizontal	N/A		N/A	N/A								
103/05-20-008-28W1/0	010562	N/A	Horizontal	N/A		N/A	N/A								
104/05-20-008-28W1/0	010563	N/A	Horizontal	N/A		N/A	N/A								
100/08-20-008-28W1/0	009796	2/18/2014	Horizontal	LODGEPOLE A	LODGEPOL	Producing	3/13/2014	Aug-2016	3.3	102.9	8031.2	0.1	4.1	907.0	3.83
											15781.5			2368.6	

TABLE NO. 4: OOIP Calculation

UWI	Average Thickness (m)	OOIP (m3)	OOIP (bbls)
01-20-008-28W1M	7.3834	101,996	641,533
02-20-008-28W1M	7.1722	99,053	623,025
03-20-008-28W1M	7.8400	108,380	681,692
04-20-008-28W1M	8.5472	118,129	743,007
05-20-008-28W1M	9.2071	127,403	801,339
06-20-008-28W1M	7.9863	110,537	695,255
07-20-008-28W1M	6.8866	95,052	597,858
08-20-008-28W1M	7.0649	97,537	613,490
Total:		858,086	5,397,199

Average Net:Gross: 0.381
Average Porosity: 12.5%
Sw: 25.0%
Boi: 1.1

Proposed Ewart Unit No. 12

Application for Enhanced Oil Recovery Waterflood Project

LIST OF APPENDICES

- | | |
|------------|------------------------------------------------|
| Appendix 1 | Ewart Unit No. 12 -- Offsetting Units |
| Appendix 2 | Ewart Unit No. 12 – Structural Cross Section |
| Appendix 3 | Ewart Unit No. 12 – Lodgepole Dolomite Isopach |
| Appendix 4 | Ewart Unit No. 12 – Mississippian Structure |
| Appendix 5 | Ewart Unit No. 12 – Dolomite Core PDPK data |
| Appendix 6 | Ewart Unit No. 12 – Dolomite Reservoir Phi*h |

APPENDIX 1

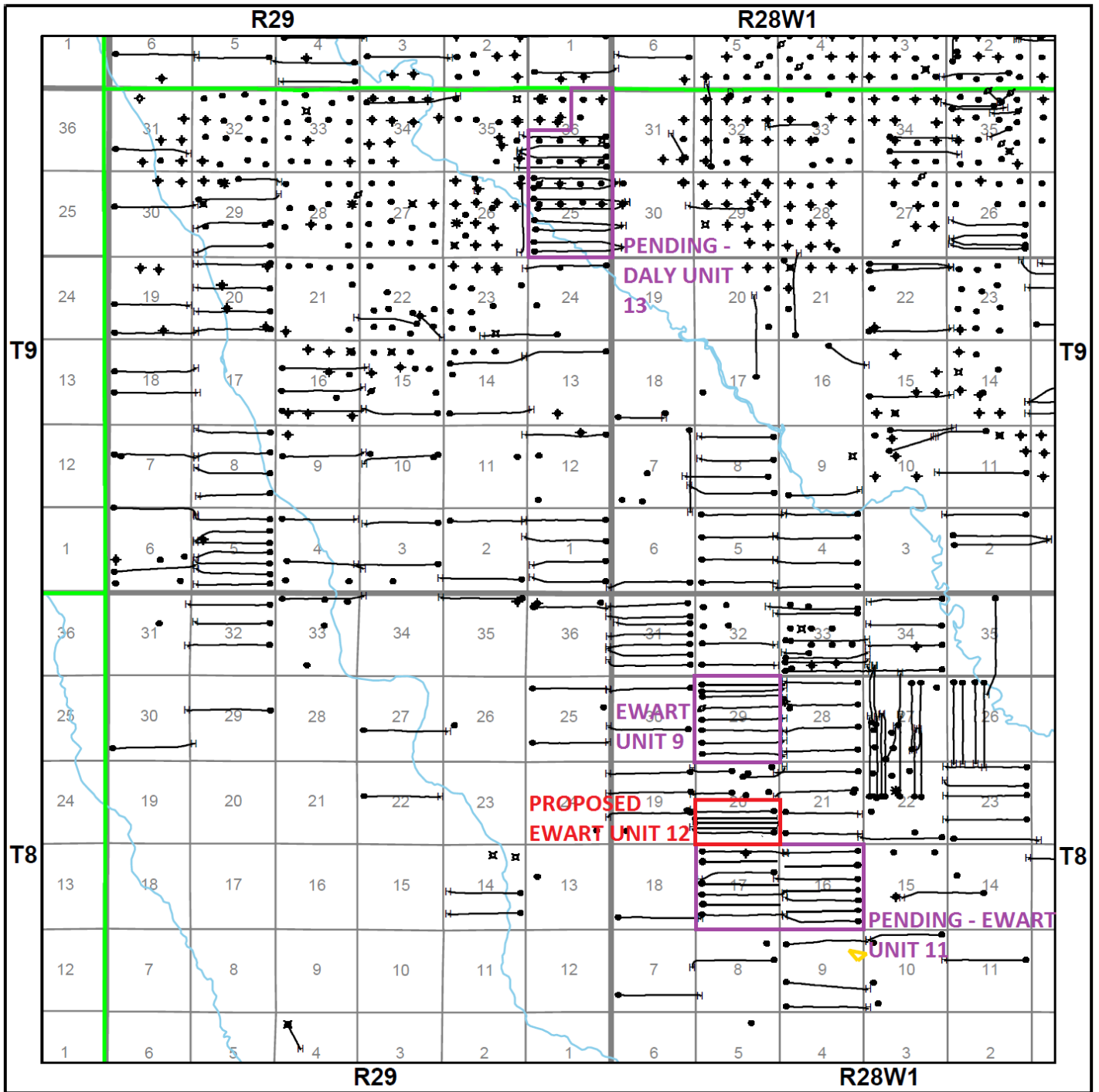

Datum: NAD27 Projection: Stereographic DLS Version AB: ATS 2.6, BC: PRB 2.0, SK: STS 2.5, MB: MLI07

Well Legend		
* Abandoned Gas	* Gas	◊ Suspended
* Abandoned Heavy Oil	* Gas Injection	* Suspended Gas
* Abandoned Oil	* Heavy Oil	* Suspended Heavy Oil
* Abandoned Oil & Gas	◊ Injection	◊ Suspended Oil
* Abandoned Service	○ Location	* Suspended Oil & Gas
○ Canceled	● Oil	Lists
◊ Drilling	* Oil & Gas	* Wells - Lpl wells2
◊ Dry & Abandoned	* Service or Drain	

Center: 49.7173, -101.2981
 Scale: 1:111,575

Sinclair Daly Dolomite Unit Overview

Map Showing Only Lodgepole Producing Wells

APPENDIX 2

A

00/05-20-008-28W1/0
 KB: 508.9 m
 RR: 2006-06-05
 FormID: BIRDBER
 TD: 970.0 m (TVI)
 MWD: 970.0 m
 FLOW: 5.20-8-28(WPM)
 TUNDRA DAILY SINCLAIR PROV. 5-20-8-28(WPM)

741.5m to next well >

00/07-20-008-28W1/0
 KB: 504.2 m
 RR: 1994-06-06
 FormID: TORQUAY
 TD: 925.0 m (TVI)
 MWD: 925.0 m
 FLOW: 7-20-8-28(WPM)
 TUNDRA DAILY SINCLAIR PROV. 7-20-8-28(WPM)

< 741.5m to previous well

571.3m to next well >

00/09-20-008-28W1/0
 KB: 503.1 m
 RR: 2008-10-31
 FormID: TORQUAY
 TD: 986.0 m (TVI)
 MWD: 986.0 m
 FLOW: 9-20-8-28(WPM)
 COREX DAILY SINCLAIR PROV. 9-20-8-28(WPM)

< 571.3m to previous well

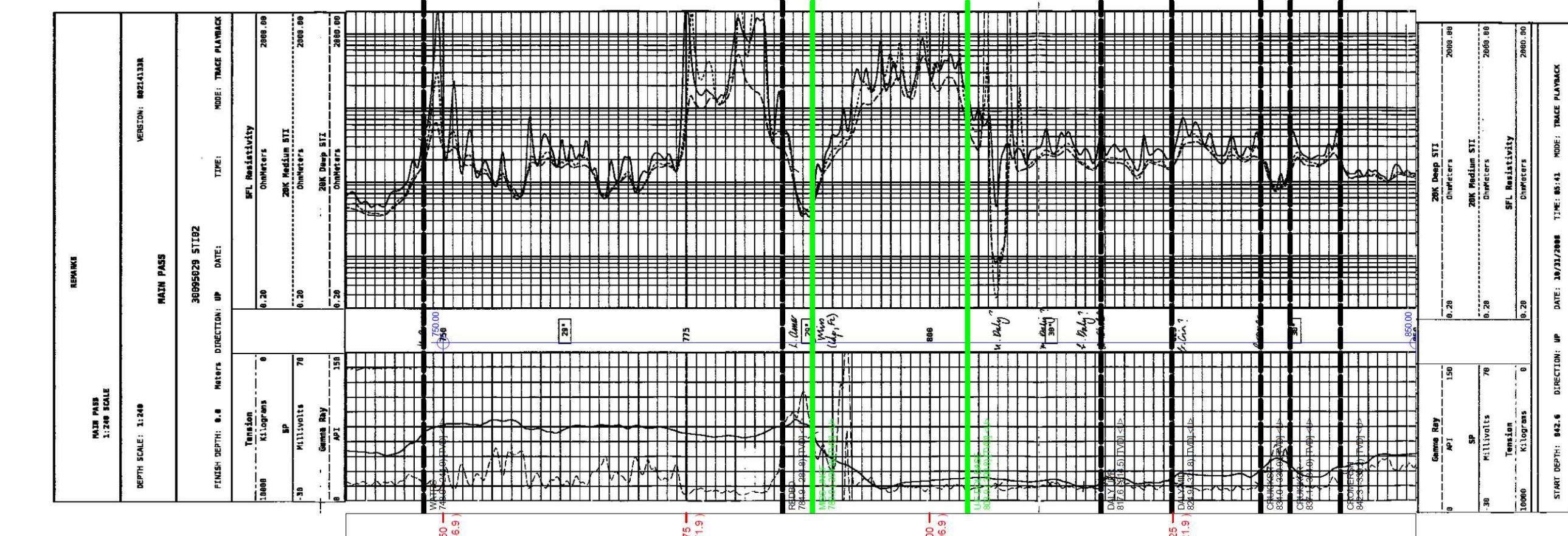
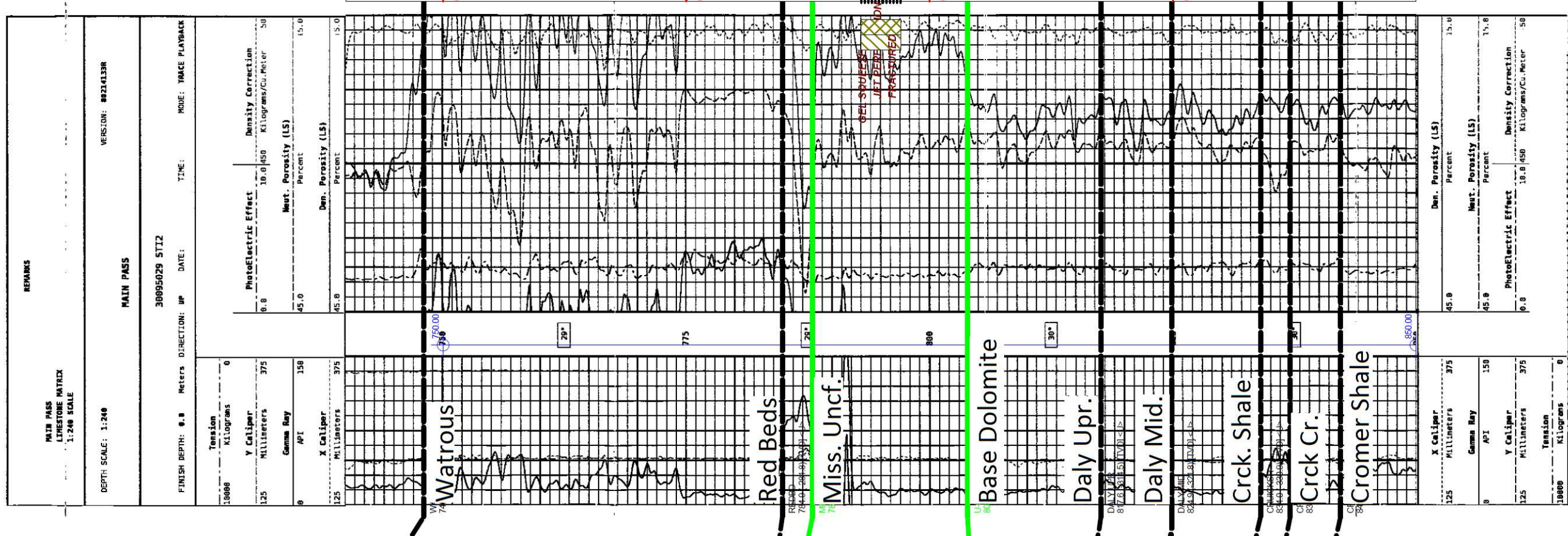
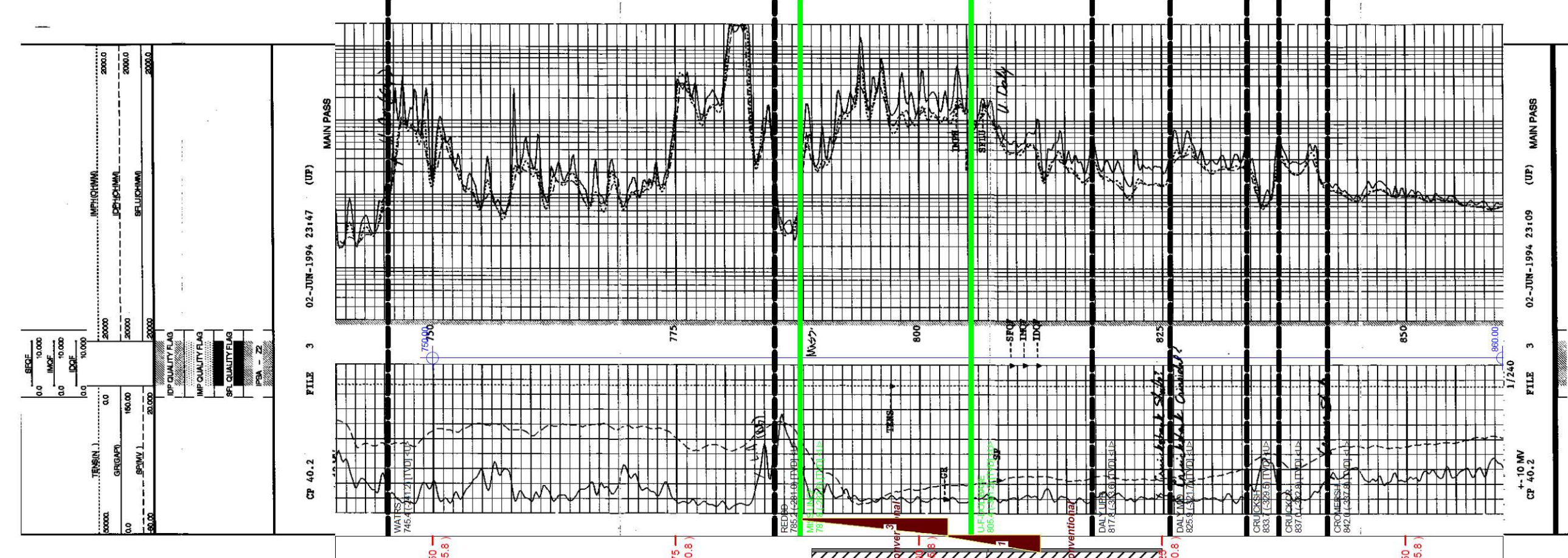
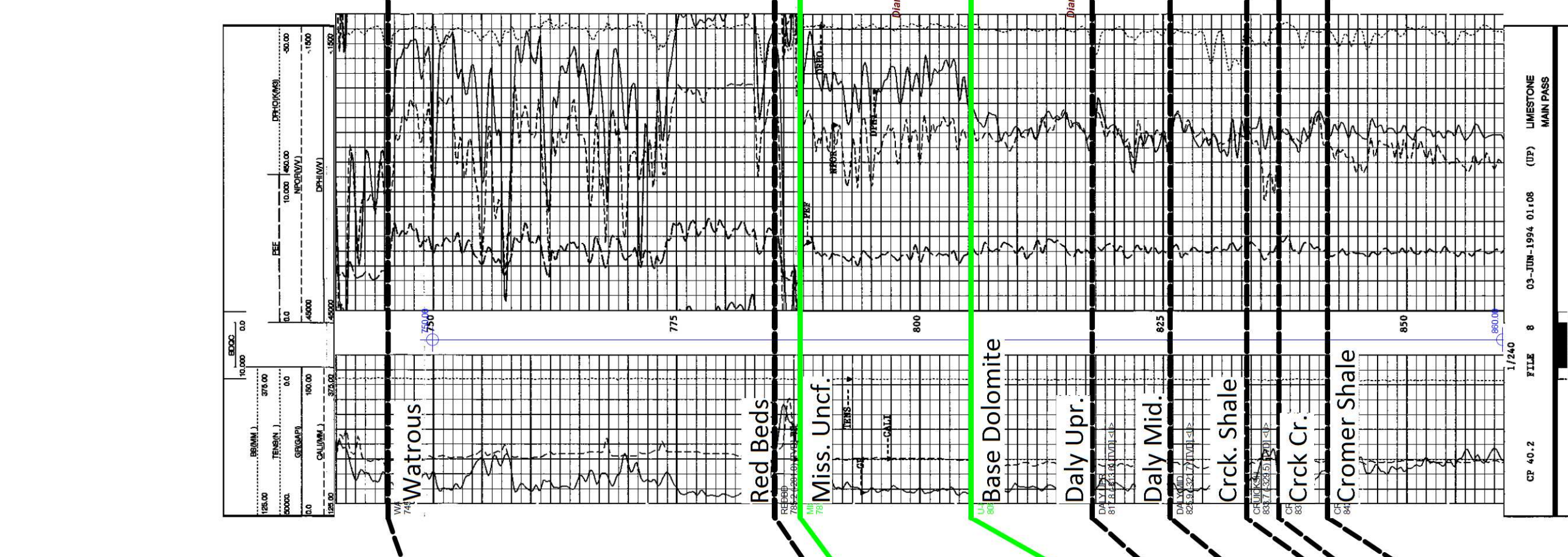
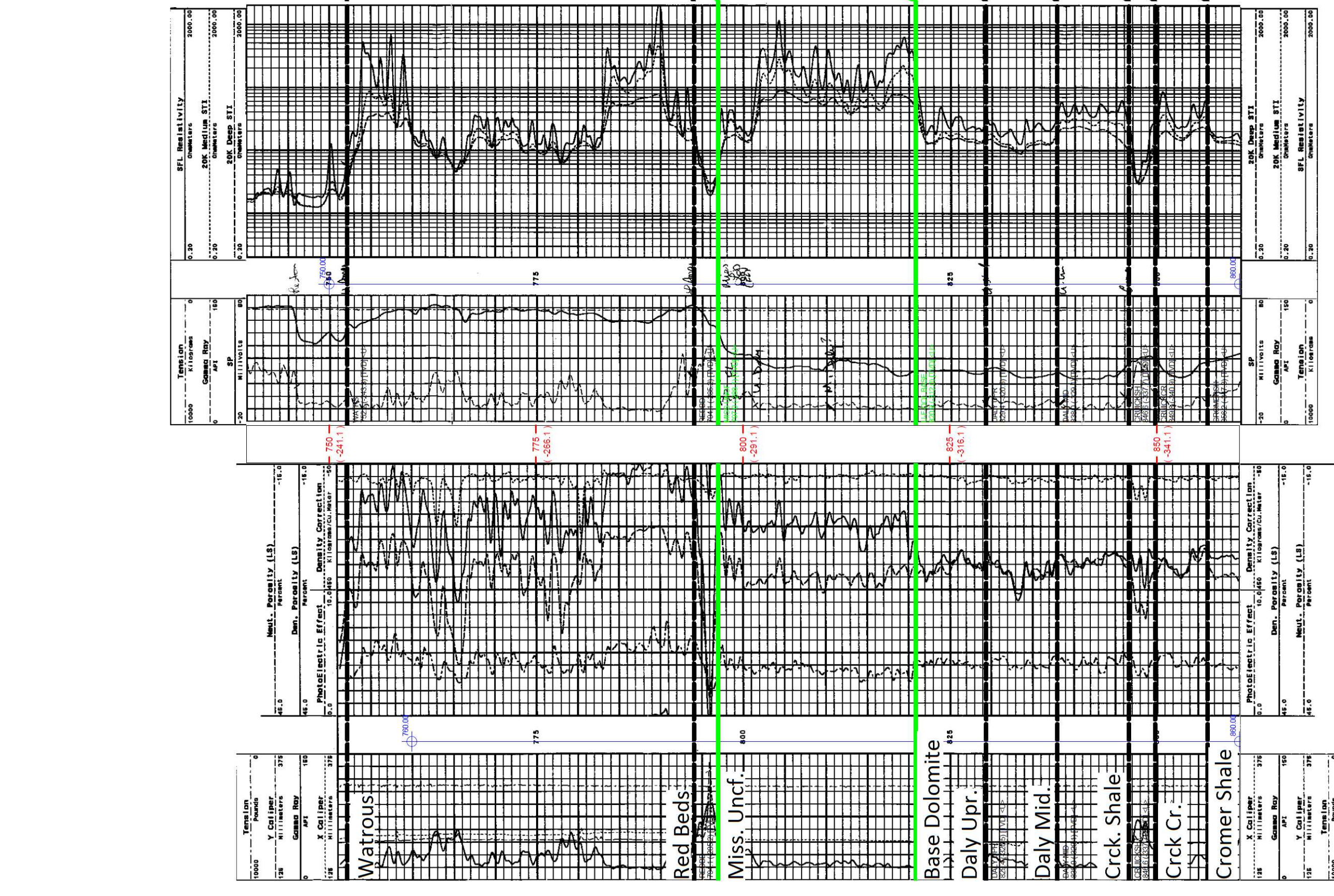

Legend

- Oil
- Dry & Abandoned
- Contact Type - Conformity
- Contact Type - Unconformity
- Contact Type - Time Equivalence
- Contact Type - Left Fault
- Contact Type - Right Fault

Proposed Ewart Unit 12

Structural Cross Section - West to East - Through Proposed Unit Area

Produced by: AcuLoops
 Version 8.2.1.78546
 Datum: NAD27
 Copyright 2015, IHS

Author: Tuesday, October 11, 2016 02:56PM
 Printed On: Tuesday, October 11, 2016 03:00PM
 Start Formation: 5m above WATRS
 End Formation: 5m above WATRS
 Cross Section Name: E120A

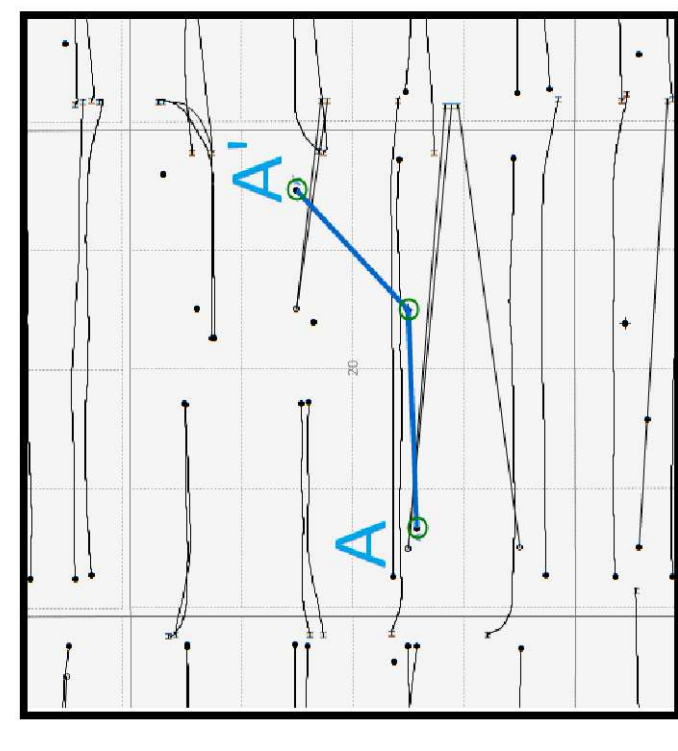

APPENDIX 3

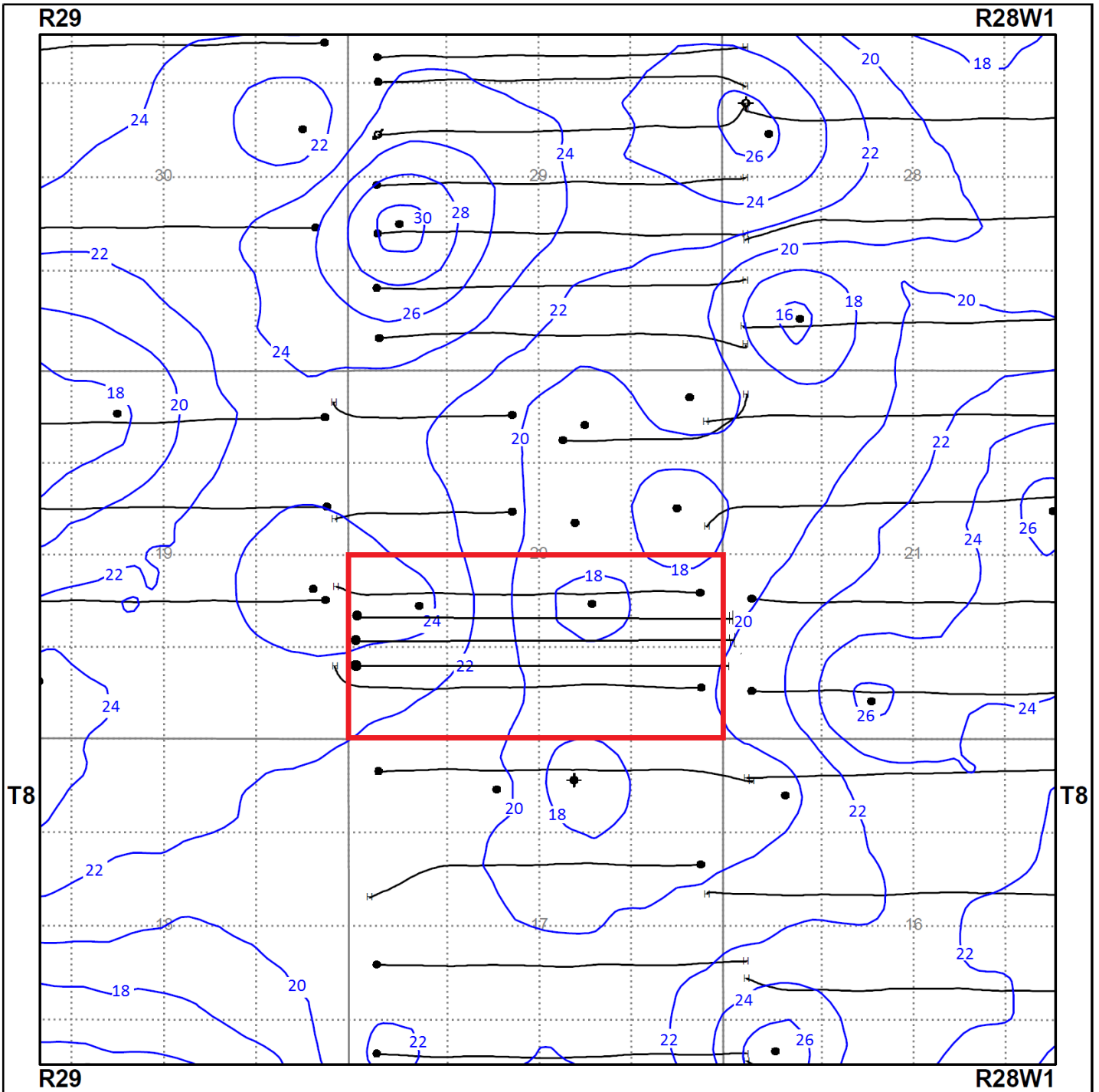

Datum: NAD27 Projection: Stereographic DLS Version AB: ATS 2.6, BC: PRB 2.0, SK: STS 2.5, MB: ML107

Center: 49.6731, -101.2461

Scale: 1:25,092

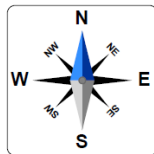
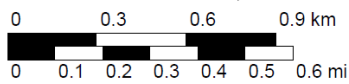

Lodgepole Dolomite Isopach (2m CI)
 Map Showing Vertical Wells and Lodgepole Producing Horizontal Wells

APPENDIX 4

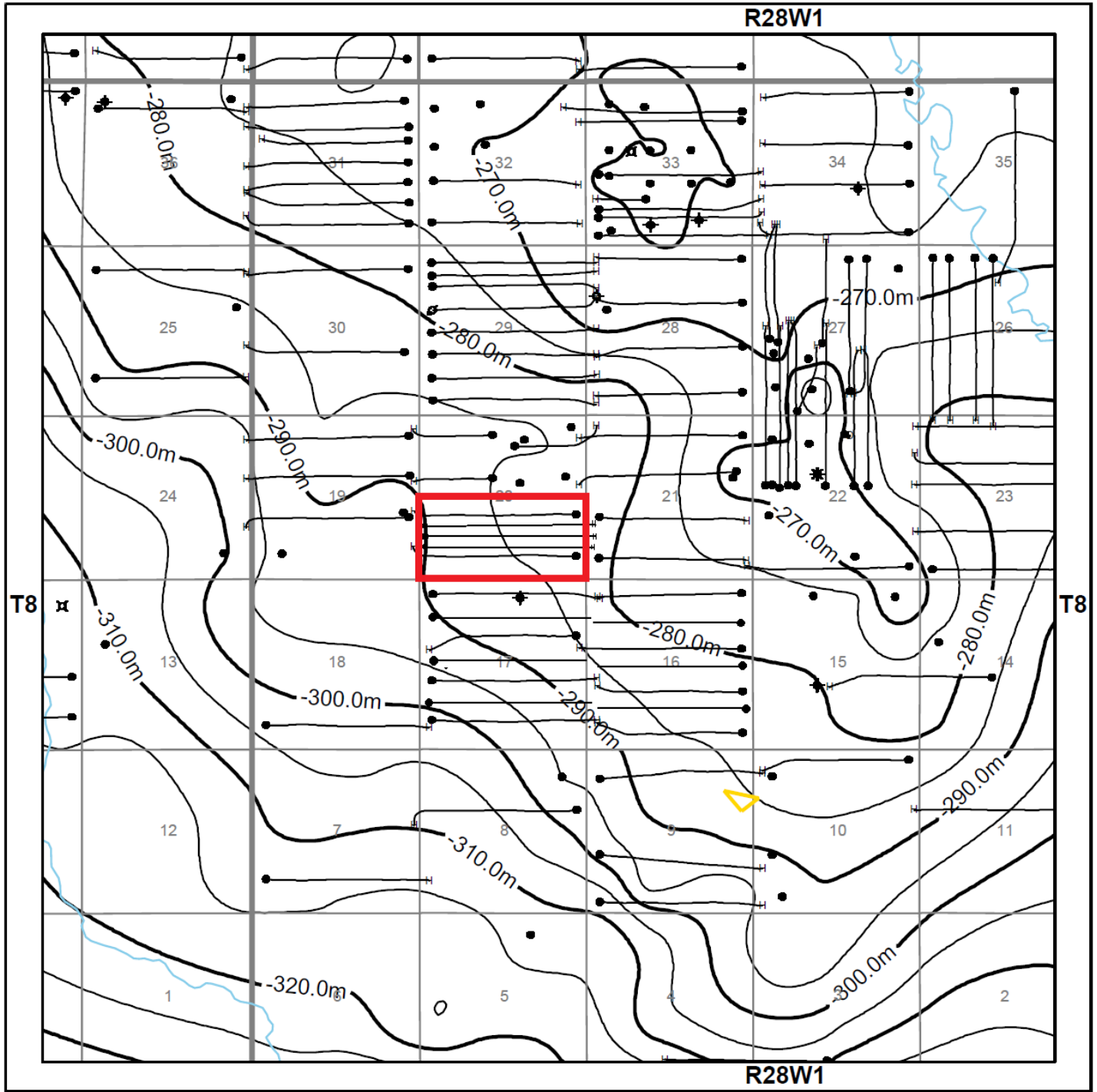

Datum: NAD27 Projection: Stereographic DLS Version AB: ATS 2.6, BC: PRB 2.0, SK: STS 2.5, MB: MLI07

Well Legend			
✱	Abandoned Gas	○	Location
✱	Abandoned Heavy Oil	●	Oil
✱	Abandoned Oil	✱	Oil & Gas
✱	Abandoned Oil & Gas	✱	Service or Drain
✱	Abandoned Service	✱	Suspended
○	Canceled	✱	Suspended Gas
○	Drilling	✱	Suspended Heavy Oil
○	Dry & Abandoned	✱	Suspended Oil
✱	Gas	✱	Suspended Oil & Gas
✱	Gas Injection	✱	
✱	Heavy Oil	✱	
✱	Injection	✱	
		Lists	
		✱	Wells - Lodgepole producing wells

Center: 49.6684, -101.2406

Scale: 1:56,165

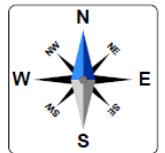
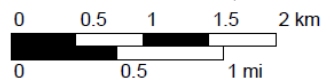

Top Lodgepole Structure (5m CI)

Map Showing Only Lodgepole Producing Wells

APPENDIX 5

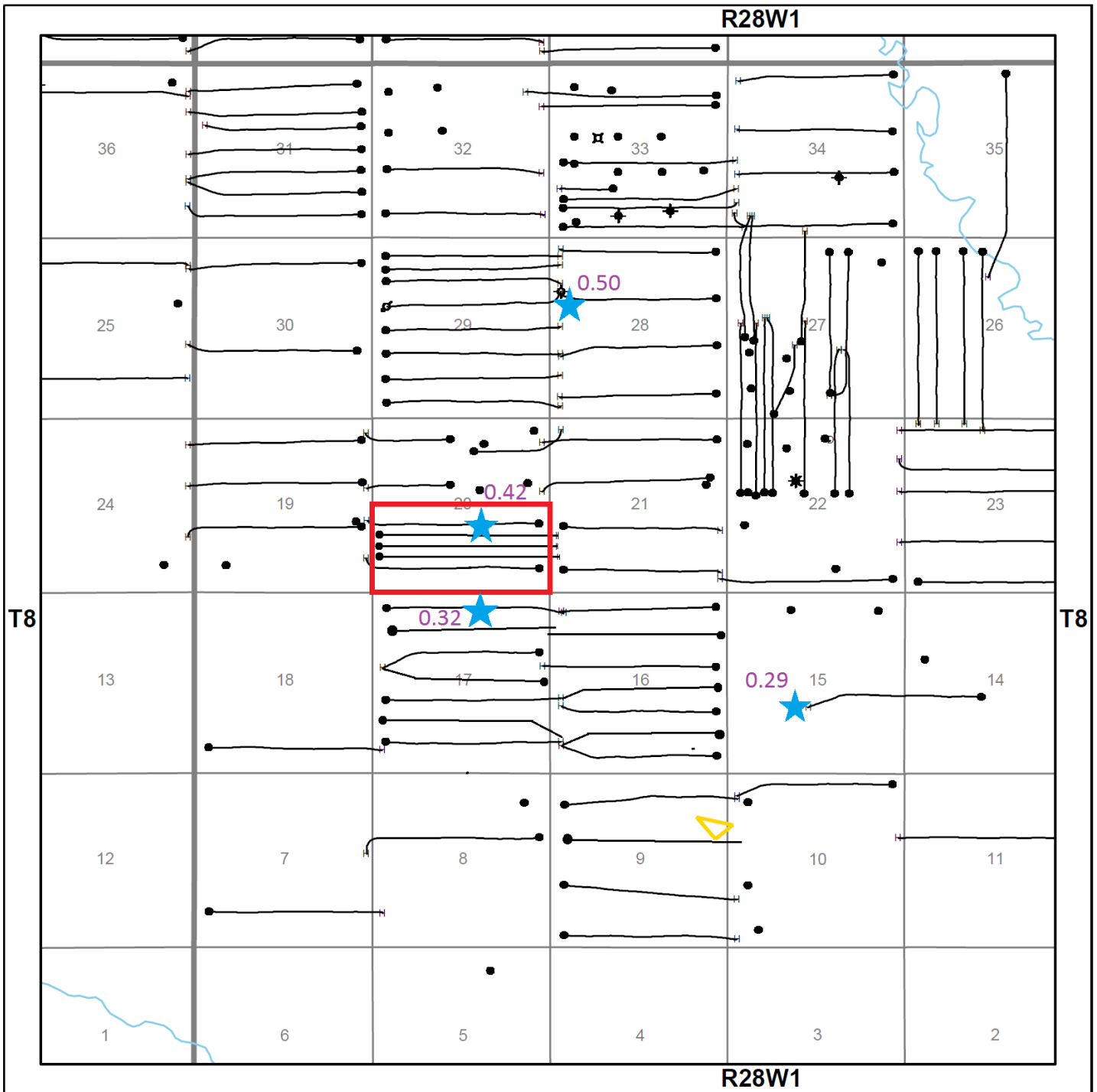

Center: 49.6692, -101.2357

Scale: 1:52,905

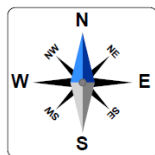
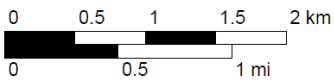

Proposed Ewart Unit 12 - Core Data

 ★ Core PDPK Points Used for OOIP
 - N/G Values Posted

APPENDIX 6

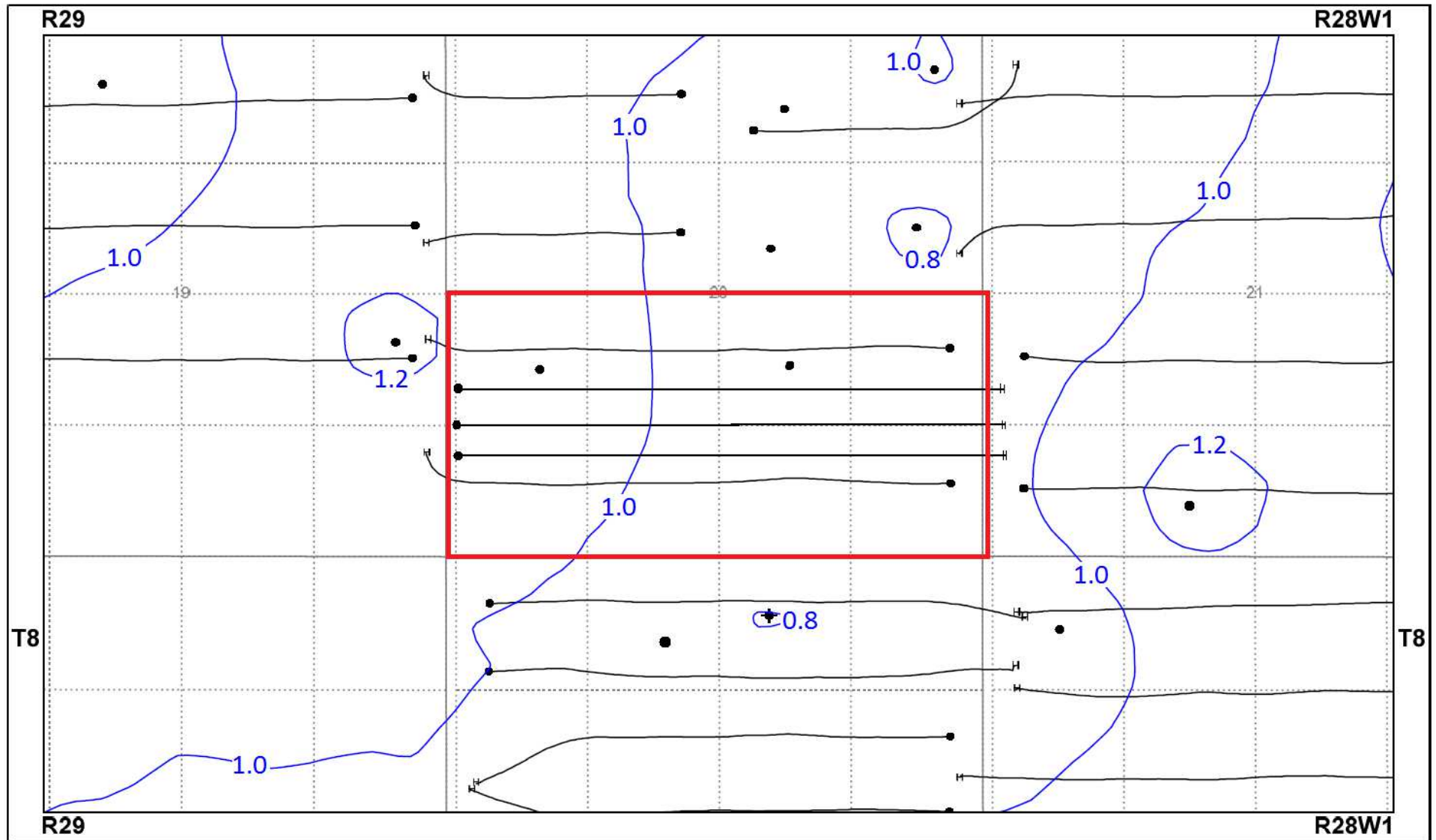

Datum: NAD27 Projection: Stereographic DLS Version AB: ATS 2.6, BC: PRB 2.0, SK: STS 2.6, MB: MLI07

Lodgepole Dolomite Phi-h (0.2m CI)
 Map Showing Vertical Wells and Lodgepole Producing Horizontal Wells

