

June 20, 2014

SUBJECT

Middle Bakken/Three Forks Formations

Bakken – Three Forks B Pool (01 62B)

Daly Sinclair Field, Manitoba

Proposed Unitization of Section 20-7-28W1

Application for Enhanced Oil Recovery Waterflood Project

INTRODUCTION

The Sinclair portion of the Daly Sinclair Oil Field is located in Ranges 28 and 29 W1 in Townships 7 and 8. Since discovery in 2004, the main oilfield area was developed with vertical wells at 40 acre spacing on Primary Production. Since early 2009, a significant portion of the main oilfield has been unitized and placed on Secondary Waterflood (WF) Enhanced Oil Recovery (EOR) Production, mainly from the Lyleton A & B members of the Three Forks Formation. Tundra Oil and Gas (Tundra) currently operates and continues to develop Sinclair Units 1, 2, 3, 5, 6, 7, 8, 10 and 11 and Ewart Units 1, 2, 3 and 4 as shown on **Figure 1**.

In the eastern part of the Sinclair field, potential exists for incremental production and reserves from a Waterflood EOR project in the Three Forks and Middle Bakken oil reservoirs. The following represents an application by Tundra to establish Ewart Unit No. 8 (Section 20-7-28W1) and implement a Secondary Waterflood EOR scheme within the Three Forks and Middle Bakken formations as outlined on **Figure 2**.

The proposed project area falls within the existing designated 01-62B Bakken-Three Forks Pool of the Daly Sinclair Oilfield (**Figure 3**).

CONCLUSIONS

1. The proposed Ewart Unit No. 8 will include 8 producing vertical wells and 3 producing horizontal wells within 16 Legal Sub Divisions (LSD) of the Middle Bakken/Three Forks producing reservoir. The project is located east of Sinclair Unit No. 2 and south of Ewart Unit No. 2 (Figure 2).
2. Total Net Original Oil in Place (OOIP) in Ewart Unit No. 8 has been calculated to be **616.0** E³m³ (3874.5 Mbbbl) for an average of **38.5** net E³m³ OOIP per 40 acre LSD.
3. Cumulative production to the end March 2014 from the 11 wells within the proposed Ewart Unit No. 8 project area was **41.4** E³m³ of oil, and **34.1** E³m³ of water, representing an **6.7%** Recovery Factor (RF) of the Net OOIP.
4. Estimated Ultimate Recovery (EUR) of Primary Proved Producing oil reserves in the proposed Ewart Unit No. 8 project area has been calculated to be **60.9** E³m³ (383.0 Mbbbl), with **19.5** E³m³ (122.7 Mbbbl) remaining as of the end of March 2014.
5. Ultimate oil recovery of the proposed Ewart Unit No. 8 OOIP, under the current Primary Production method, is forecasted to be **9.9%**.
6. Figure 4 shows the production from the Ewart Unit No. 8 which peaked in March 2009 at 42.8 m³ of oil per day (OPD). As of March 2014, production was 8.9 m³ OPD, 5.8 m³ of water per day (WPD) and a 36.8% watercut.
7. In March 2009, production averaged 3.9 m³ OPD per well in Ewart Unit No. 8. As of March 2014, average per well production has declined to 0.81 m³ OPD. Decline analysis of the group primary production data forecasts total oil to continue declining at an annual rate of approximately **16.8%** in the project area.
8. Estimated Ultimate Recovery (EUR) of proved oil reserves under Secondary WF EOR for the proposed Ewart Unit No. 8 has been calculated to be **99.4** E³m³ (625.8 Mbbbl), with **58.1** E³m³ (365.5 Mbbbl) remaining. An incremental **38.5** E³m³ (242.8 Mbbbl) of proved oil reserves, or **6.2%**, are forecasted to be recovered under the proposed Unitization and Secondary EOR production vs the existing Primary Production method.
9. Total RF under Secondary WF in the proposed Ewart Unit No. 8 is estimated to be **16.1%**.
10. Based on waterflood response in the adjacent main portion of the Sinclair field, the Three Forks and Middle Bakken Formations in the proposed project area are believed to be suitable reservoirs for WF EOR operations.
11. Tundra intends to convert two (2) horizontal producers to injection as well as drill another horizontal producer (Figure 5) within the proposed Ewart Unit No. 8. This unit will have a combination of waterflood patterns at 20 acre and 40 acre spacing having utilized the existing horizontal and vertical wells in the area.

DISCUSSION

RESOURCE POTENTIAL IN PROPOSED EWART UNIT NO. 8

The proposed Ewart Unit No. 8 project area is located within Township 7, Range 28 W1 of the Daly Sinclair oil field. The proposed Ewart Unit No. 8 currently consists of 8 producing vertical wells and 3 producing horizontal wells within an area covering Section 20-7-28W1 (Figure 2). A project area well list complete with recent production statistics is attached as Table 3.

Tundra believes that the waterflood response in the adjacent main portion of the Sinclair field demonstrates potential for incremental production and reserves from a WF EOR project in the subject Middle Bakken and/or Three Forks oil reservoirs.

Geology

Stratigraphy:

The stratigraphy of the reservoir section for the proposed unit is shown on the structural cross section attached as Appendix 1. The section runs W to E through the southern limit of the proposed Unit. The producing sequence in descending order consists of the Upper Bakken Shale, Middle Bakken Siltstone, Lyleton A Siltstone, the Red Shale, Lyleton B Siltstone and the Torquay silty shale. The reservoir units are represented by the Middle Bakken, Lyleton A and Lyleton B Siltstones. The Upper Bakken Shale is a black, organic rich, platy shale which forms the top seal for the underlying Middle Bakken/Lyleton B reservoirs. The reservoir units in the proposed unit are analogous to the Bakken / Lyleton producing reservoirs that have been approved adjacent to the proposed unit (Sinclair Unit 2 and Ewart Unit 2) Appendix 2.

Sedimentology:

The Middle Bakken reservoir consists of fine to coarse grained grey siltstone to fine sandstone which may be subdivided on the basis of lithologic characteristics into upper and lower units. The upper portion is very often heavily bioturbated and is generally non-reservoir. These bioturbated beds often contain an impoverished fauna consisting of well-worn brachiopod, coral and occasional crinoid fragments suggesting deposition in a marginal marine environment. The lower part of the Middle Bakken is generally finely laminated with alternating light and dark laminations with occasional bioturbation. Reservoir quality is highly variable within the Unit area. Within the proposed unit, the Middle Bakken ranges from 0.5 m on the West side to just over 1.5 m on the Eastern boundary (Appendix 3).

The Lyleton A reservoir within the proposed unit area consists of buff to tan medium to coarse siltstone (occasionally fine sandstone) made up of quartz, feldspar and detrital dolomite with minor mica and clay mostly in the form of clay clasts or chips. Clays do not generally occur as pore filling material, but rather as discrete grains within the siltstone. The Upper part is generally well bedded and shows evidence of parallel lamination with occasional wind ripples. The coarser siltstones are interbedded with finer grained grey-green siltstone similar in composition to the reservoir siltstone, but generally with lower permeability (i.e. < 0.1 md). These finer grained siltstones show evidence of haloturbation producing smeared siltstone clasts floating in a fine grained grey-green siltstone matrix. The lower part of the

Lyleton A generally shows a greater proportion of the grey-green fine-grained siltstone than the Upper and is generally a poorer reservoir. It also tends to exhibit greater amounts of haloturbation and pseudo-breccia of siltstone clasts in a finer grained siltstone matrix. Because of the fine grained matrix in this pseudo-breccia, the connectivity between the clasts is much lower than the bedded siltstone and the Lower part of the Lyleton A is generally a poorer reservoir than the Upper part of the Lyleton A. Within the proposed unit area, the Upper Lyleton A is present throughout most of the section but it pinches out along the Northwestern edge of the proposed boundary (Appendix 4). The Lower Lyleton A is continuous in the section but thins Eastward from approximately 3.0m to less than 2.0m in the Southeast (Appendix 5).

The Red Shale forms an aquitard between the Lyleton A and B reservoirs and consists of brick red dolomitic siltstones which are highly water soluble. The Red Shale is generally between 3.0m and 3.5m thick with the area of the proposed unit (Appendix 6).

The Lyleton B reservoir consists of buff to tan very fine grained siltstone (occasionally very fine siltstone) made up of quartz, feldspar and detrital dolomite with minor mica and clay mostly in the form of clay clasts or chips. The Lyleton B is generally well-bedded and shows evidence of parallel lamination with occasional wind ripples. The coarser siltstones are interbedded with dark grey-green very fine grained siltstone which is generally non-reservoir. The Lyleton B is approximately 5.0m thick within the proposed unit (Appendix 7).

The Torquay (Three Forks) forms the base of the reservoir sequence and is a brick red dolomitic fine to very fine siltstone similar to the Red Shale Marker that forms a good basal seal to the Lyleton B reservoir.

Structure:

Structure contour maps are provided for the top of each major unit (Appendices 8 through 13). The structure within the proposed unit area generally consists of a gentle dip to the SW. Structural variations in the area are interpreted as being caused by dissolution of the underlying Prairie Evaporites. Structural variations caused by dissolution are common in the Sinclair Field but do not appear to represent continuous barriers to lateral fluid flow within the reservoir as they do not appear to interrupt the lateral continuity of the reservoir beds (Appendix 1).

Reservoir Continuity:

Lateral continuity of the reservoir units is an essential requirement of a successful waterflood and as demonstrated by the cross-section (Appendix 1) and the isopach maps, the lateral continuity of the reservoir units within proposed Ewart Unit No. 8 is very good. While the Upper Lyleton A unit can be shown to be depositionally thin laterally, it can be demonstrated to be by pre-Middle Bakken erosion removing the underlying sequences from the top down.

Vertical continuity between the Middle Bakken and underlying Lyleton A reservoir is good and there is no evidence of an intervening aquitard between these units. In fact it is often difficult even in core to pick the unconformity surface between these units. The vertical continuity between the Lyleton A and Lyleton B reservoirs is obviously non-existent due to the presence of the Red Shale Marker which represents an effective barrier to vertical flow (Appendix 1).

Reservoir Quality:

Permeability (k-h in mD*m) and porosity (Phi-h in por*m) maps for all four reservoir units are provided (Appendix 13 through 21). These maps are generated using core data and are generated as follows. First the core is divided into the reservoir units present. This data is then subject to a permeability cutoff. Intervals that meet or exceed the cutoff are multiplied by the interval thickness and then summed to get the total value for the Phi-h or k-h for that particular reservoir unit. The value of the permeability cutoffs for each formation are the same values used by GLJ for third party reserve evaluations on Tundra's Sinclair properties. The permeability cutoffs applied are as follows:

- Middle Bakken = 0.5 md
- Upper Lyleton A = 1.0 md
- Lower Lyleton A = 1.0 md
- Lyleton B = 0.5 md

As can be noted from the Phi-h and k-h maps the bulk of the reservoir in the proposed unit is contained in the Middle Bakken and Lyleton A formations. It is important to note that the 0.5 md cutoff effectively ignores pore volume with permeability between 0.2 and 0.49 md that may contain moveable oil.

Fluid Contacts:

The oil/water contact for the Middle Bakken and Lyleton reservoir is estimated from production to be at about -525 m subsea. In tight reservoirs such as these the transition zone could be considerable and the top of the transition zone is estimated to be at about -490 m subsea based on production and simulation studies of the reservoir. The postulated oil/water contact at -525 m subsea is below the lowest contour on any of the attached structure contour maps.

OOIP Estimates

OOIP was calculated by Tundra Geologists Barry Larson and Todd Neely. Barry holds a BSc. in Geology from the U of S and has 35 years of industry experience, 19 of which are in the Williston Basin. Todd Neely holds a BSc. in Geology from the University of Manitoba, and has 15 years of industry experience, 4 of which are in the Williston Basin. The dataset used to determine the OOIP values for Ewart Unit 8 was originally compiled by Barry Larson. It consists of conventional core analysis of all available core in the Sinclair area. Todd took over Barry's dataset in 2012. Ultimately, OOIP values for Ewart Unit 8 were generated by Todd, using Barry's original dataset.

Total volumetric OOIP for the Middle Bakken and Lyleton B within the proposed unit has been calculated to be **616.0 E³m³** (3874.8 Mbbl) using Tundra internally created maps. Maps used were generated from core data from 316 wells available in the greater Sinclair area (Appendix 22)

Net pay for each cored well is calculated using the formation specific permeability cut off discussed above. Representative intervals that had a measured permeability greater than the formation specific cutoff were considered pay. The weighted average porosity (phi) of all pay intervals for each formation was calculated for each cored well. The height of pay (h) was derived by summing the heights of each representative sample that met the permeability cut off. From these two parameters, a phi*h value was calculated for all four productive horizons in all wells with core over each respective formation.

The phi*h values for all cored wells were contoured using Golden Software’s “Surfer 9” program using a 500 m grid node spacing. Phi*h values for each LSD were calculated off the associated Surfer 9 grid by determining the values at the center of each LSD.

Tabulated parameters for each LSD from the calculations can be found in [Table 4](#).

OOIP values were calculated using the following volumetric equation:

$$OOIP = \frac{Area * Net Pay * Porosity * (1 - Water Saturation)}{Initial Formation Volume Factor of Oil}$$

or

$$OOIP(m3) = \frac{A * h * \phi * (1 - Sw)}{Bo} * \frac{10,000m2}{ha}$$

or

$$OOIP(Mbbl) = \frac{A * h * \phi * (1 - Sw)}{Bo} * 3.28084 \frac{ft}{m} * 7,758.367 \frac{bbl}{acre * ft} * \frac{1Mbbl}{1,000bbl}$$

where

OOIP	= Original Oil in Place by LSD (Mbbl, or m3)
A	= Area (40 acres, or 16.187 hectares, per LSD)
h * φ	= Net Pay * Porosity, or Phi * h (ft, or m)
Bo	= Formation Volume Factor of Oil (stb/rb, or sm3/rm3)
Sw	= Water Saturation (decimal)

The initial oil formation volume factor was adopted from a PVT taken from the 3-3-8-29 Sinclair Bakken well, thought to be representative of the fluid characteristics in the reservoir.

A listing of Middle Bakken/Three Forks formation rock and fluid properties used to characterize the reservoir are provided in [Table 5](#).

Historical Production

A historical group production history plot for the proposed Ewart Unit No. 8 is shown as [Figure 4](#). Oil production commenced from the proposed Unit area in December 2004 and peaked during March 2009 at 42.8 m³ OPD.

As of March 2014, production was 8.9 m³ of OPD, 5.6 m³ of WPD and a 36.8% watercut. From peak production in March 2009 to date, oil production is declining at an annual rate of approximately **16.8%** under the current Primary Production method.

The field's production rate indicates the need for pressure restoration and maintenance, and waterflooding is deemed to be the most efficient means of re-introducing energy back into the reservoir system and to provide areal sweep between wells.

UNITIZATION

Unitization and implementation of a Waterflood EOR project is forecasted to increase overall recovery of OOIP to **16.1%**. The basis for unitization is to develop the lands in an effective manner that will be conducive to waterflooding. Unitizing will enable the reservoir to have the greatest recovery possible by allowing the development of additional drilling and injector conversions over time, in order to maintain reservoir pressure and increase oil production.

Unit Name

Tundra proposes that the official name of the new Unit covering Section 20-7-28W1 shall be Ewart Unit No. 8.

Unit Operator

Tundra Oil and Gas Partnership (Tundra) will be the Operator of record for Ewart Unit No. 8.

Unitized Zone

The Unitized zone(s) to be waterflooded in the Ewart Unit No. 8 will be the Middle Bakken and Three Forks formations.

Unit Wells

The 8 vertical wells and 3 horizontal wells to be included in the proposed Ewart Unit No. 8 are outlined in **Table 3**.

Unit Lands

Ewart Unit No. 8 will consist of 16 LSD as follows:

Section 20 of Township 7, Range 28, W1M

The lands included in the 40 acre tracts are outlined in **Table 1**.

Tract Factors

The proposed Ewart Unit No. 8 will consist of 16 Tracts based on the 40 acre LSD's containing the existing 8 vertical and 3 horizontal producing wells.

The Tract Factor contribution for each of the LSD's within the proposed Ewart Unit No. 8 was calculated as follows:

- Gross OOIP by LSD, minus cumulative production to date for the LSD as distributed by the LSD specific Production Allocation (PA) % in the applicable producing horizontal or vertical well (to yield Remaining Gross OOIP)
- Tract Factor by LSD = the product of Remaining Gross OOIP by LSD as a % of total proposed Unit Remaining Gross OOIP

Tract Factor calculations for all individual LSD's based on the above methodology are outlined within **Table 2**.

Working Interest Owners

Table 1 outlines the working interest (WI) for each recommended Tract within the proposed Ewart Unit No. 8. Tundra Oil and Gas Partnership holds a 100% WI ownership in all the proposed Tracts. The Crown is the lessor.

Tundra Oil and Gas Partnership will have a 100% WI in the proposed Ewart Unit No. 8.

WATERFLOOD EOR DEVELOPMENT

Technical Studies

The waterflood performance predictions for the proposed Ewart Unit No. 8 Bakken project are based on internal engineering assessments. Project area specific reservoir and geological parameters were utilized and then compared to Sinclair Unit No. 1 parameters, yielding the WF EOR response observed there to date.

As Tundra has a direct comparison of waterflood performance in Sinclair Unit 1, Tundra does not feel it is crucial to construct a simulation model for this area.

Pre-Production of New Horizontal Injection Wells

Primary production from the vertical and horizontal producing wells in the proposed Ewart Unit No. 8 has declined significantly from peak rate indicating a need for secondary pressure support. Two (2) of the existing producing horizontal wells will be converted to horizontal injection wells upon approval as shown in **Figure 5**. This will result in effective 20 acre and 40 acre waterflood patterns within Ewart Unit No. 8. Since the proposed horizontal injection wells have already been on production for a period of time there will not be a need for an additional pre-production period within this unit.

Tundra monitors reservoir pressure, fluid production and decline rates in each pattern to determine the best time for each well to be converted to water injection.

Reserves Recovery Profiles and Production Forecasts

The primary waterflood performance predictions for the proposed Ewart Unit No. 8 are based on oil production decline curve analysis, and the secondary predictions are based on internal engineering analysis performed by the Tundra reservoir engineering group.

Primary Production Forecast

Cumulative production to the end March 2014 from the 11 wells within the proposed Ewart Unit No. 8 project area was 41.4 E³m³ of oil, and 34.1 E³m³ of water, representing an 6.7% Recovery Factor (RF) of the calculated Net OOIP.

Ultimate Primary Proved Producing oil reserves recovery for Ewart Unit No. 8 has been estimated to be **60.9 E³m³**, or a **9.9%** Recovery Factor (RF) of OOIP. Remaining Producing Primary Reserves has been estimated to be **19.5 E³m³** to the end of March 2014. The expected production decline and forecasted cumulative oil recovery under continued Primary Production is shown in **Figures 7 and 8**.

Pre-Production Schedule/Timing for Conversion of Horizontal Wells to Water Injection

Tundra will plan an injection conversion schedule to allow for the most expeditious development of the waterflood within the proposed Ewart Unit No. 8, while maximizing reservoir knowledge (**Table 6**).

Criteria for Conversion to Water Injection Well

Two (2) water injection wells are required for this proposed unit as shown in **Figure 5**.

Tundra will monitor the following parameters to assess the best timing for each individual horizontal well to be converted from primary production to water injection service.

- Measured reservoir pressures at start of and/or through primary production
- Fluid production rates and any changes in decline rate
- Any observed production interference effects with adjacent vertical and horizontal wells
- Pattern mass balance and/or oil recovery factor estimates
- Reservoir pressure relative to bubble point pressure

The above schedule allows for the proposed Ewart Unit No. 8 project to be developed equitably, efficiently, and moves to project to the best condition for the start of waterflood as quickly as possible. It also provides the Unit Operator flexibility to manage the reservoir conditions and response to help ensure maximum ultimate recovery of OOIP.

Secondary EOR Production Forecast

Secondary Waterflood plots of the expected oil production forecast over time and the expected oil production v. cumulative oil are plotted in **Figures 9 and 10**, respectively. Total Secondary EUR for the proposed Ewart Unit No. 8 is estimated to be **99.4 E³m³** with **58.1 E³m³** remaining representing a total secondary recovery factor of **16.1%** for the proposed Unit area. An incremental **38.5 E³m³** of oil, or an incremental **6.2%** recovery factor, are forecasted to be recovered under the proposed Unitization and Secondary EOR production scheme vs. the existing Primary Production method.

Estimated Fracture Pressure

Completion data from the existing producing wells within the project area indicate a fracture pressure gradient range of 18.0 to 22.0 kPa/m true vertical depth (TVD). Tundra expects the fracture gradient encountered during completion of the proposed horizontal injection well will be somewhat lower than these values due to expected reservoir pressure depletion.

WATERFLOOD OPERATING STRATEGY

Water Source

The injection water for the proposed Ewart Unit No. 8 will be supplied from the existing Sinclair 3-4-8-29W1 Battery source and injection water system. All existing injection water is obtained from the Lodgepole formation in the 102/16-32-7-29W1 licensed water source well. Lodgepole water from the 102/16-32 source well is pumped to the main Sinclair Units Water Plant at 3-4-8-29W1, filtered, and pumped up to injection system pressure. A diagram of the Sinclair water injection system and new pipeline connection to the proposed Ewart Unit No. 8 project area injection wells is shown as **Figure 12 and 13**.

Produced water is not currently used for any water injection in the Tundra operated Sinclair Units and there are no current plans to use produced water as a source supply for Ewart Unit No. 8.

Since all producing Middle Bakken/Three Forks wells in the Daly Sinclair area, whether vertical or horizontal, have been hydraulically fractured, produced waters from these wells are inherently a mixture of Three Forks and Bakken native sources. This mixture of produced waters has been extensively tested for compatibility with 102/16-32 source Lodgepole water, by a highly qualified third party, prior to implementation by Tundra in Sinclair Unit 1. All potential mixture ratios between the two waters, under a range of temperatures, have been simulated and evaluated for scaling and precipitate producing tendencies. Testing of multiple scale inhibitors has also been conducted and minimum inhibition concentration requirements for the source water volume determined. At present, continuous scale inhibitor application is maintained into the source water stream out of the Sinclair injection water facility. Review and monitoring of the source water scale inhibition system is also part of an existing routine maintenance program.

Injection Wells

The two (2) water injection wells for the proposed Ewart Unit No. 8 have been drilled, are currently producing and plans are in progress to re-configure the wells for downhole injection after approval for waterflood has been received (**Figure 11**). The horizontal injection wells have been stimulated by multiple hydraulic fracture treatments to obtain suitable injection. Tundra has extensive experience with horizontal fracturing in the area, and all jobs are rigorously programmed and monitored during execution. This helps ensure optimum placement of each fracture stage to prevent, or minimize, the potential for out-of-zone fracture growth and thereby limit the potential for future out-of-zone injection.

The new water injection wells will be placed on injection after approval to inject. Wellhead injection pressures will be maintained below the least value of either:

- the area specific known and calculated fracture gradient, or
- the licensed surface injection Maximum Allowable Pressure (MOP)

Tundra has a thorough understanding of area fracture gradients. A management program will be utilized to set and routinely review injection target rates and pressures vs. surface MOP and the known area formation fracture pressures.

All new water injection wells are surface equipped with injection volume metering and rate/pressure control. An operating procedure for monitoring water injection volumes and meter balancing will also be utilized to monitor the entire system measurement and integrity on a daily basis.

The proposed Ewart Unit No. 8 horizontal water injection well rate is forecasted to average **10 – 25 m³ WPD**, based on expected reservoir permeability and pressure.

Reservoir Pressure

No recent or representative initial pressure surveys are available for the proposed Ewart Unit No. 8 project area in the Bakken formation. The extremely long shut-in and build-up times required to obtain any possible representative surveys from the producing wells are economically prohibitive. Tundra will make all attempts to capture a reservoir pressure survey in the proposed horizontal injection wells during the completion of the well and prior to injection or production.

Reservoir Pressure Management during Waterflood

Tundra expects it will take 2-4 years to re-pressurize the reservoir due to cumulative primary production voidage and pressure depletion. Initial monthly Voidage Replacement Ratio (VRR) is expected to be approximately 1.25 to 2.00 within the patterns during the fill up period. As the cumulative VRR approaches 1, target reservoir operating pressure for waterflood operations will be 75-90% of original reservoir pressure.

Waterflood Surveillance and Optimization

Ewart Unit No. 8 EOR response and waterflood surveillance will consist of the following:

- Regular production well rate and WCT testing
- Daily water injection rate and pressure monitoring vs target
- Water injection rate/pressure/time vs. cumulative injection plot
- Reservoir pressure surveys as required to establish pressure trends
- Pattern VRR
- Potential use of chemical tracers to track water injector/producer responses
- Use of some or all of: Water Oil Ratio (WOR) trends, Log WOR vs Cum Oil, Hydrocarbon Pore Volumes Injected, Conformance Plots

The above surveillance methods will provide an ever increasing understanding of reservoir performance, and provide data to continually control and optimize the Ewart Unit No. 8 waterflood operation. Controlling the waterflood operation will significantly reduce or eliminate the potential for out-of-zone injection, undesired channeling or water breakthrough, or out-of-Unit migration. The monitoring and surveillance will also provide early indicators of any such issues so that waterflood operations may be altered to maximize ultimate secondary reserves recovery from the proposed Ewart Unit No. 8.

On Going Reservoir Pressure Surveys

For each openhole horizontal injection well, a measured reservoir pressure will be obtained prior to water injection. Tundra expects useful reservoir pressure data may be obtained from existing vertical wells within the project area after WF start up. These pressures will be reported within the Annual Progress Reports for Ewart Unit No. 8 as per Section 73 of the Drilling and Production Regulation.

Economic Limits

Under the current Primary recovery method, existing wells within the proposed Ewart Unit No. 8 will be deemed uneconomic when the net oil rate and net oil price revenue stream becomes less than the current producing operating costs. With any positive oil production response under the proposed Secondary recovery method, the economic limit will be significantly pushed out into the future. The actual economic cut off point will then again be a function of net oil price, the magnitude and duration of production rate response to the waterflood, and then current operating costs. Waterflood projects generally become uneconomic to operate when Water Oil Ratios (WOR's) exceed 100.

WATER INJECTION FACILITIES

The Ewart Unit No. 8 waterflood operation will utilize the existing Tundra operated source well supply and water plant (WP) facilities located at 3-4-8-29 W1M which supplies the existing Sinclair Units.

A complete description of all planned system design and operational practices to prevent corrosion related failures is shown in **Figure 14**.

NOTIFICATION OF MINERAL AND SURFACE RIGHTS OWNERS

Tundra is in the process of notifying all mineral rights and surface rights owners of this proposed EOR project and formation of Ewart Unit No. 8. Copies of the notices and proof of service, to all surface and mineral rights owners will be forwarded to the Petroleum Branch when available to complete the Ewart Unit No. 8 Application.

Ewart Unit No. 8 Unitization, and execution of the formal Ewart Unit No. 8 Agreement by affected Mineral Owners, is expected during Q3 2014. Copies of same will be forwarded to the Petroleum Branch, when available, to complete the Ewart Unit No. 8 Application.

Should the Petroleum Branch have further questions or require more information, please contact Abhy Pandey at 403.767.1247 or by email at abhy.pandey@tundraoilandgas.com.

TUNDRA OIL & GAS PARTNERSHIP

Original Signed by Abhy Pandey, Exploitation Engineer, June 20, 2014

Proposed Ewart Unit No. 8
Application for Enhanced Oil Recovery Waterflood Project

List of Figures

Figure 1	Daly Field Area Map
Figure 2	Ewart Unit No. 8 Proposed Boundary
Figure 3	Bakken-Three Forks A Pool
Figure 4	Ewart Unit No. 8 Historical Production
Figure 5	Ewart Unit No. 8 Development Plan
Figure 6	Sinclair Pilot Waterflood Section 4 Production Profile
Figure 7	Ewart Unit No. 8 Primary Recovery – Rate v. Time
Figure 8	Ewart Unit No. 8 Primary Recovery – Rate v. Cumulative Oil
Figure 9	Ewart Unit No. 8 Primary + Secondary Recovery – Rate v. Time
Figure 10	Ewart Unit No. 8 Primary + Secondary Recovery – Rate v. Cumulative Oil
Figure 11	Typical Cemented Liner Water Injection Well Downhole Diagram
Figure 12	Sinclair Water Injection System
Figure 13	Typical Water Injection Surface Wellhead Piping Diagram
Figure 14	Planned Corrosion Program

Proposed Ewart Unit No. 8
Application for Enhanced Oil Recovery Waterflood Project

List of Tables

Table 1	Tract Participation
Table 2	Tract Factor Calculation
Table 3	Current Well List and Status
Table 4	Original Oil in Place and Recovery Factors
Table 5	Reservoir and Fluid Properties
Table 6	Ewart Unit No. 8 – Project Schedule

Proposed Ewart Unit No. 8

Application for Enhanced Oil Recovery Waterflood Project

List of Appendices

Appendix 1	Structural Cross-Section
Appendix 2	Map of Offsetting Units
Appendix 3	Middle Bakken Isopach
Appendix 4	Upper Lyleton A Isopach
Appendix 5	Lower Lyleton A Isopach
Appendix 6	Red Shale Isopach
Appendix 7	Lyleton B Isopach
Appendix 8	Middle Bakken Structure
Appendix 9	Upper Lyleton A Structure
Appendix 10	Lower Lyleton A Structure
Appendix 11	Red Shale Structure
Appendix 12	Lyleton B Structure
Appendix 13	Torquay Structure
Appendix 14	Middle Bakken k^*h @ 0.5 mD CO
Appendix 15	Upper Lyleton A k^*h @ 1.0 mD CO
Appendix 16	Lower Lyleton A k^*h @ 1.0 mD CO
Appendix 17	Lyleton B k^*h @ 0.5 mD CO
Appendix 18	Middle Bakken ϕ^*h @ 0.5 mD CO
Appendix 19	Upper Lyleton A ϕ^*h @ 1.0 mD CO
Appendix 20	Lower Lyleton A ϕ^*h @ 1.0 mD CO
Appendix 21	Lyleton B ϕ^*h @ 0.5 mD CO
Appendix 22	Area Cored Wells

R30

R29

R28W1

T9

T9

T8

T8

T7

T7

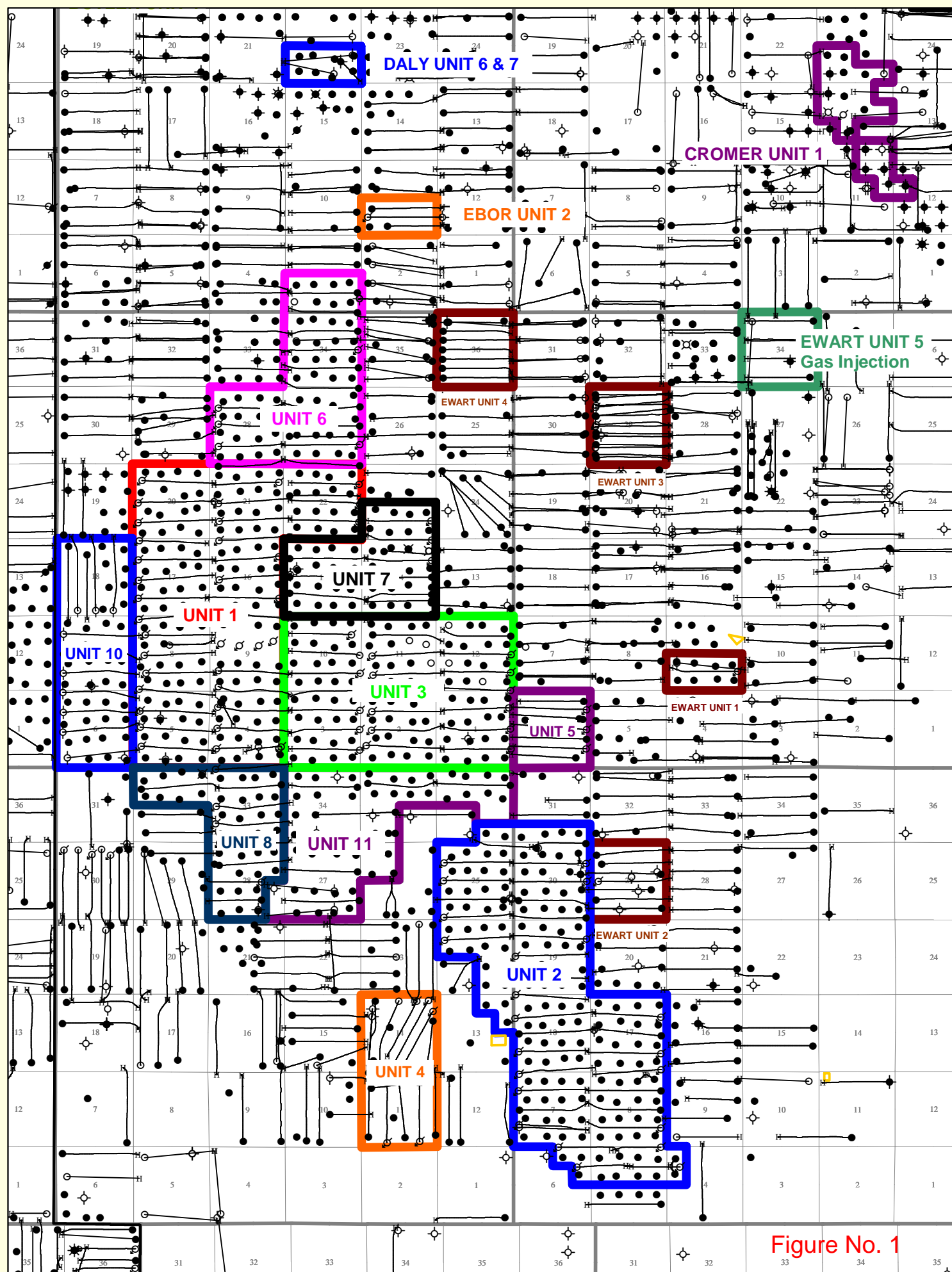

Figure No. 1

R30

R29

R28W1

R29

R28W1

Figure No. 2

T8

T8

UNIT 5

EWART UNIT 1

EWART UNIT 2

UNIT 2

Proposed EWART UNIT 8

T7

T7

R29

R28W1

Figure No. 3

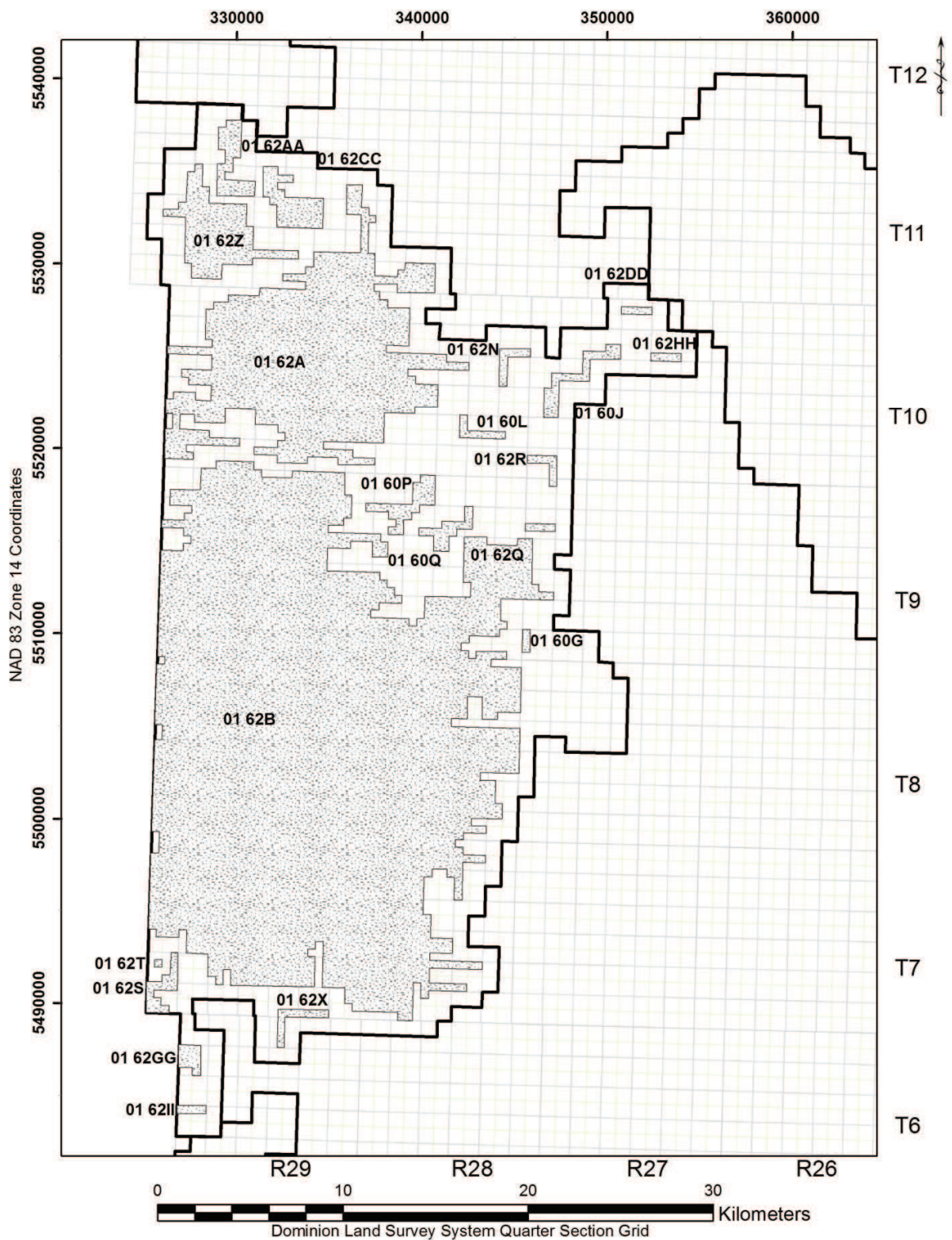

Figure 13 - Daly Sinclair Bakken & Bakken-Three Forks Pools
(01 60A - 01 60BB & 01 62A - 01 62II)

Ewart Unit No. 8

Figure No. 4

Production Graph

# of Wells:	11	Prod Zone:	BAKKEN; THREEFK; TORQUAY	On Prod:	2004-12 to 2014-03
Fluid:	Oil	Field:	DALY (1)	Cum Oil:	41354.4 m3
Mode:	Producing	Pool Code:	62B	Cum Gas:	0.0 E3m3
		Unit Code:		Cum Wtr:	34108.9 m3

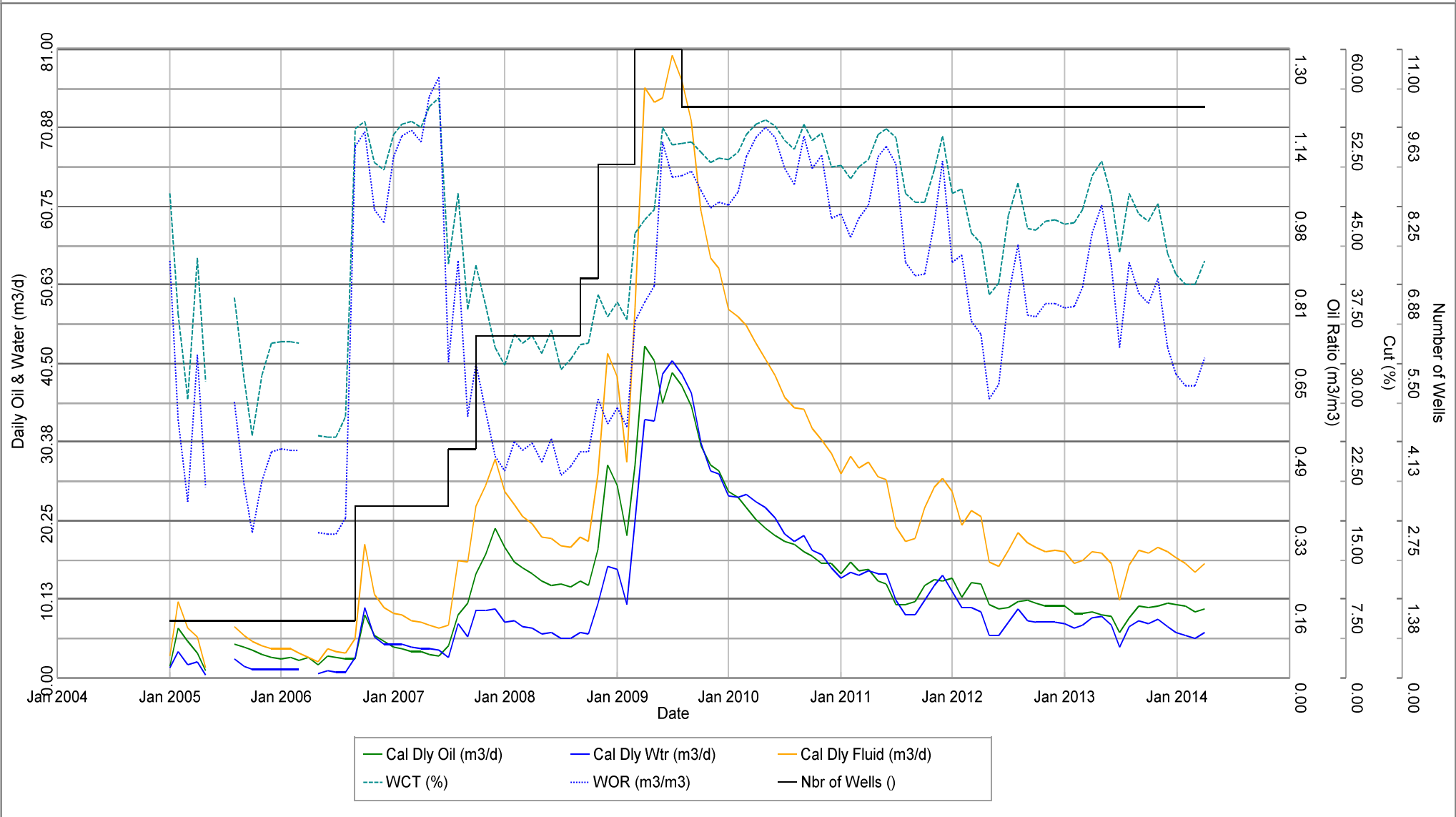
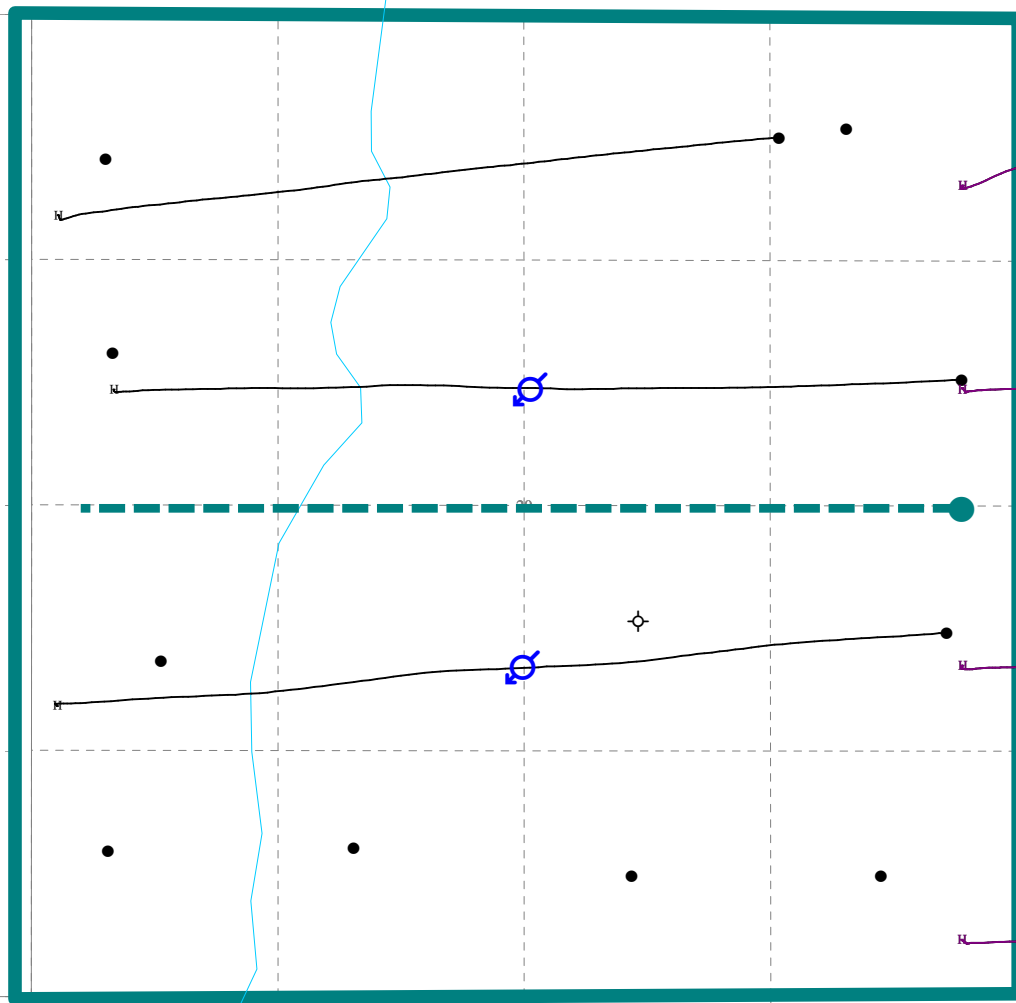

Figure No. 5



Proposed EWART UNIT 8 Development

**1 infill producer to be drilled;
2 existing producers to be converted to injectors**

Sinclair Unit No. 1 Analog

Figure No. 6

Production Graph

# of Wells:	16	Prod Zone:	BAKKEN; TORQUAY	On Prod:	2004-12 to 2014-02
Fluid:	Oil; Water Injection	Field:	DALY (1)	Cum Oil:	145249.5 m3
Mode:	Producing; Injection	Pool Code:	62B	Cum Gas:	0.0 E3m3
		Unit Code:	162B01	Cum Wtr:	22626.7 m3

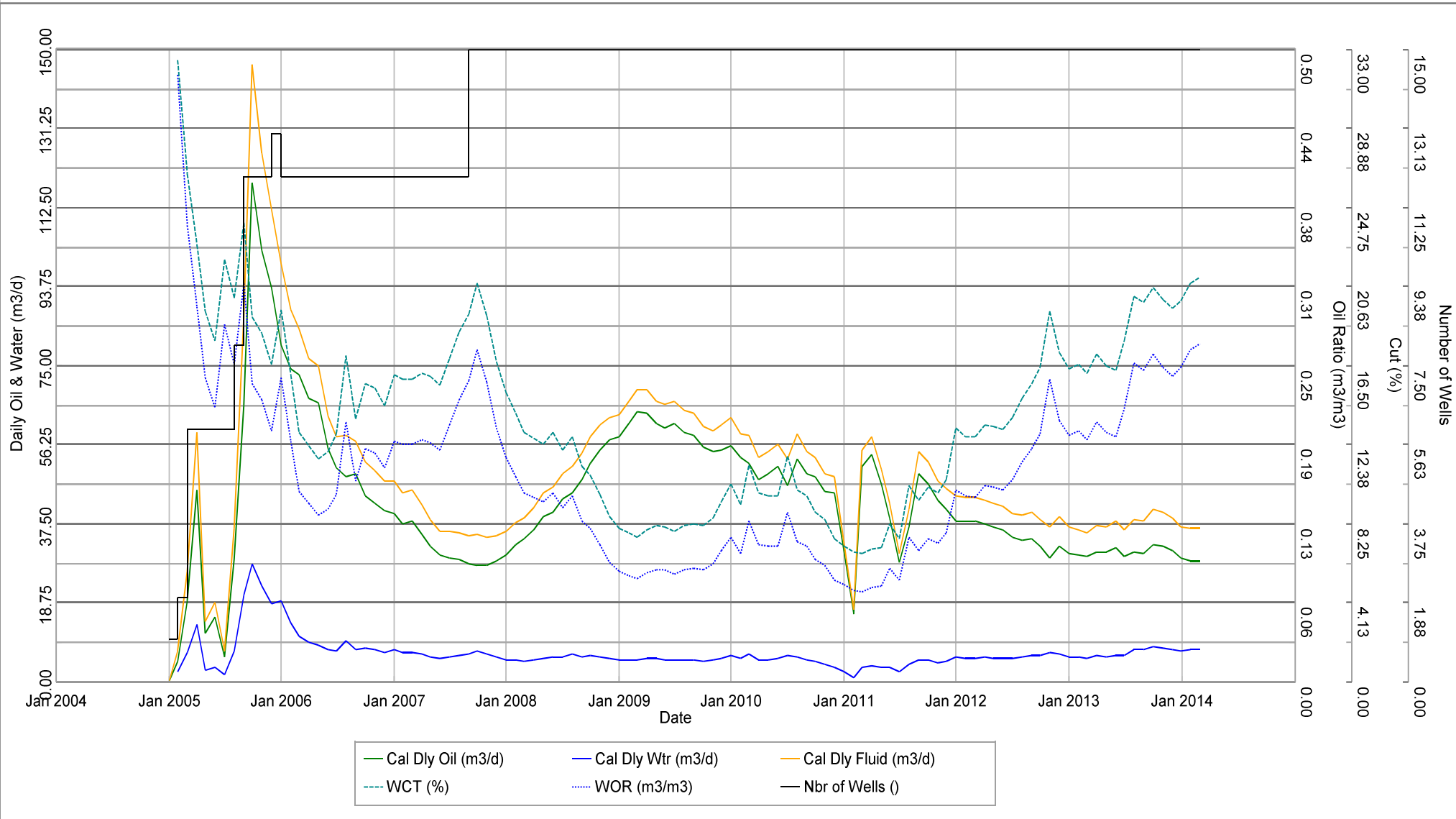

— Cal Dly Oil (m3/d) — Cal Dly Wtr (m3/d) — Cal Dly Fluid (m3/d)
- - - WCT (%) . . . WOR (m3/m3) — Nbr of Wells ()

Figure No. 7

Province: Manitoba
 Field: DALY SINCLAIR
 Pool: BAKKEN-THREE FORKS B
 Unit: multi zone (11)
 Status: n/a
 Operator: Tundra O&G Ptnshp

Primary Recovery

Proposed Ewart Unit 8
 Ewart 8 for Unit App
 Base

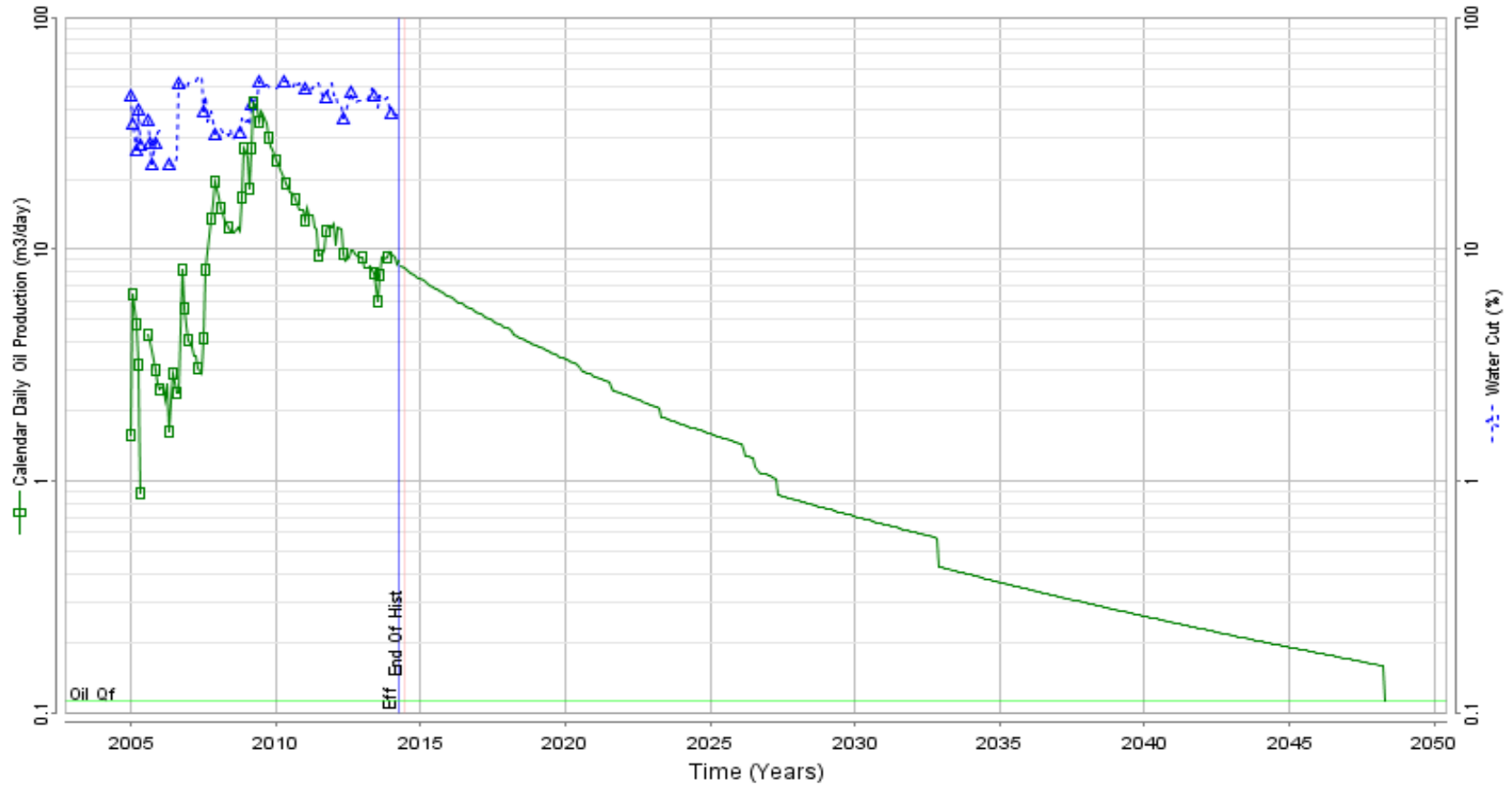

Cum Oil(m3):	41,354	Cum Gas(E3m3):	0	Cum Water(m3):	34,109	Cum Cond(m3):	0
Forecast Start:	04/01/2014	Calculation Type:	Undefined	Est. Cum Prod (m3):	41,354	Decline Exponent:	0.000
Forecast End:	04/30/2048	OMP (m3):	0	Remaining (m3):	19,504	Initial Decline (%/yr):	0.0
Initial Rate (m3):	8.4	Recovery Factor:	0.000				
Final Rate (m3):	0.1	Ult. Recoverable (m3):	60,859				

Figure No. 8

Province: Manitoba
 Field: DALY SINCLAIR
 Pool: BAKKEN-THREE FORKS B
 Unit: multi zone (11)
 Status: n/a
 Operator: Tundra O&G Ptnshp

Proposed Ewart Unit 8
 Ewart 8 for Unit App
 Base

Primary Recovery

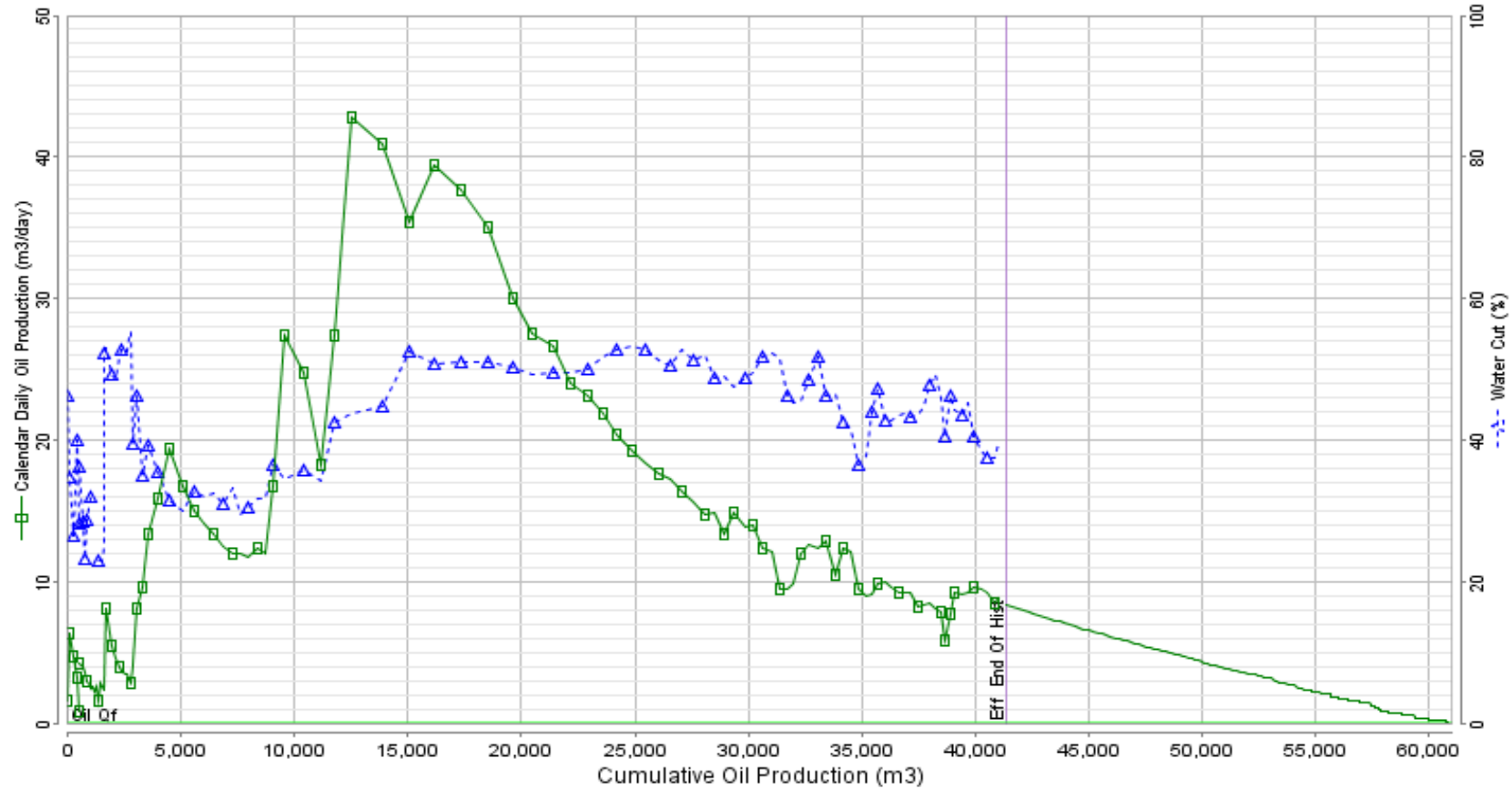

Cum Oil(m3):	41,354	Cum Gas(E3m3):	0	Cum Water(m3):	34,109	Cum Cond(m3):	0
Forecast Start:	04/01/2014	Calculation Type:	Undefined	Est. Cum Prod (m3):	41,354	Decline Exponent:	0.000
Forecast End:	04/30/2048	O'VP (m3):	0	Remaining (m3):	19,504	Initial Decline (%/yr):	0.0
Initial Rate (m3):	8.4	Recovery Factor:	0.000				
Final Rate (m3):	0.1	Ult. Recoverable (m3):	60,859				

Figure No. 9

Province: Manitoba
 Field: DALY SINCLAIR
 Pool: BAKKEN-THREE FORKS B
 Unit: multi zone (11)
 Status: n/a
 Operator: Tundra O&G Ptnshp

Proposed Ewart Unit 8
 Ewart 8 for Unit App
 Base+G1+G2

Primary + Secondary Recovery

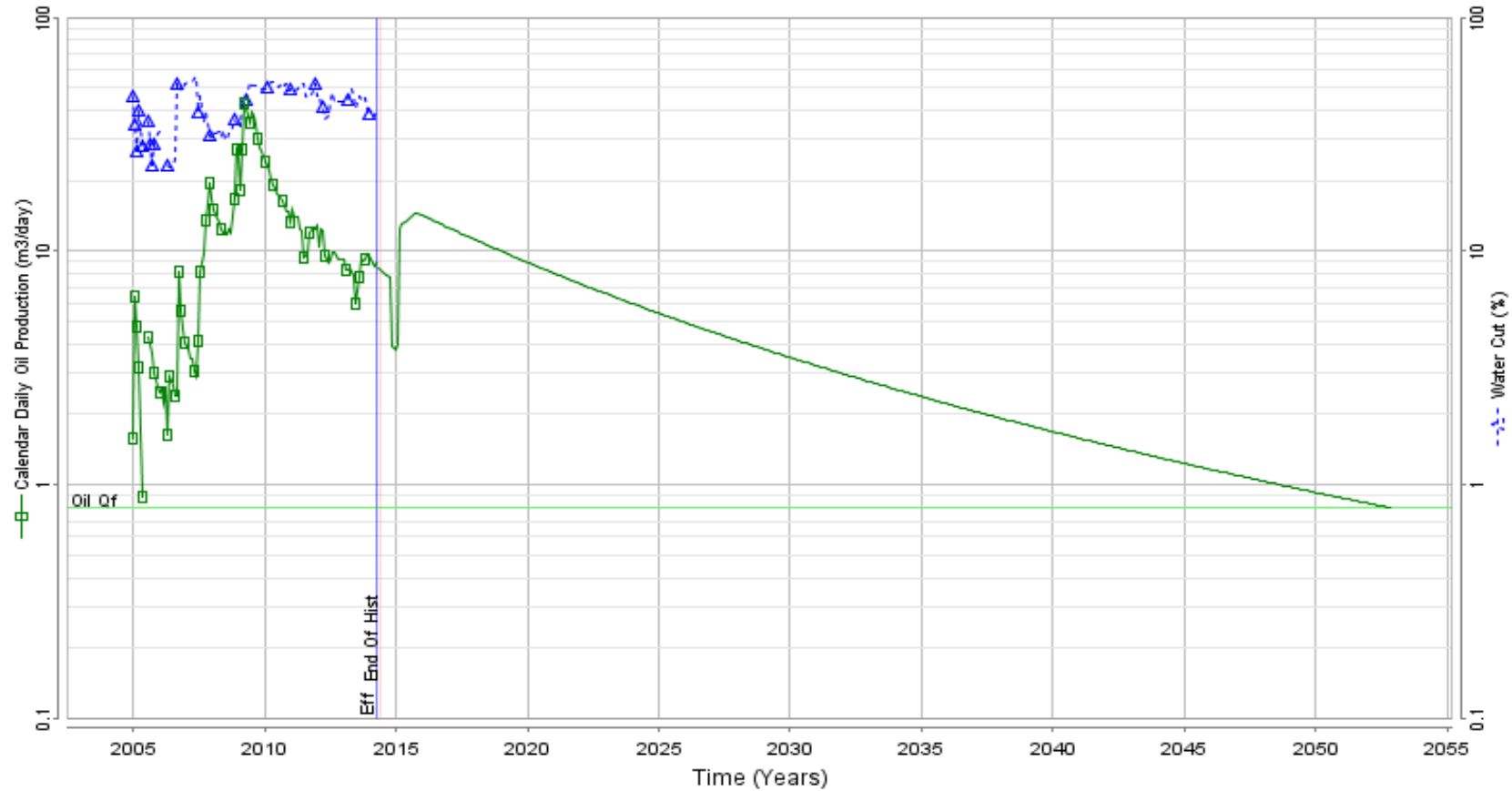

Cum Oil(m3):	41,354	Cum Gas(E3m3):	0	Cum Water(m3):	34,109	Cum Cond(m3):	0
Forecast Start:	04/01/2014	Calculation Type:	Undefined	Est. Cum Prod (m3):	41,354	Decline Exponent:	0.000
Forecast End:	10/24/2052	OVP (m3):	0	Remaining (m3):	58,086	Initial Decline (%/yr):	0.0
Initial Rate (m3):	8.4	Recovery Factor:	0.000				
Final Rate (m3):	0.8	Ult. Recoverable (m3):	99,441				

Figure No. 10

Province: Manitoba
 Field: DALY SINCLAIR
 Pool: BAKKEN-THREE FORKS B
 Unit: multi zone (11)
 Status: n/a
 Operator: Tundra O&G Ptnshp

Proposed Ewart Unit 8
 Ewart 8 for Unit App
 Base+G1+G2

Primary + Secondary Recovery

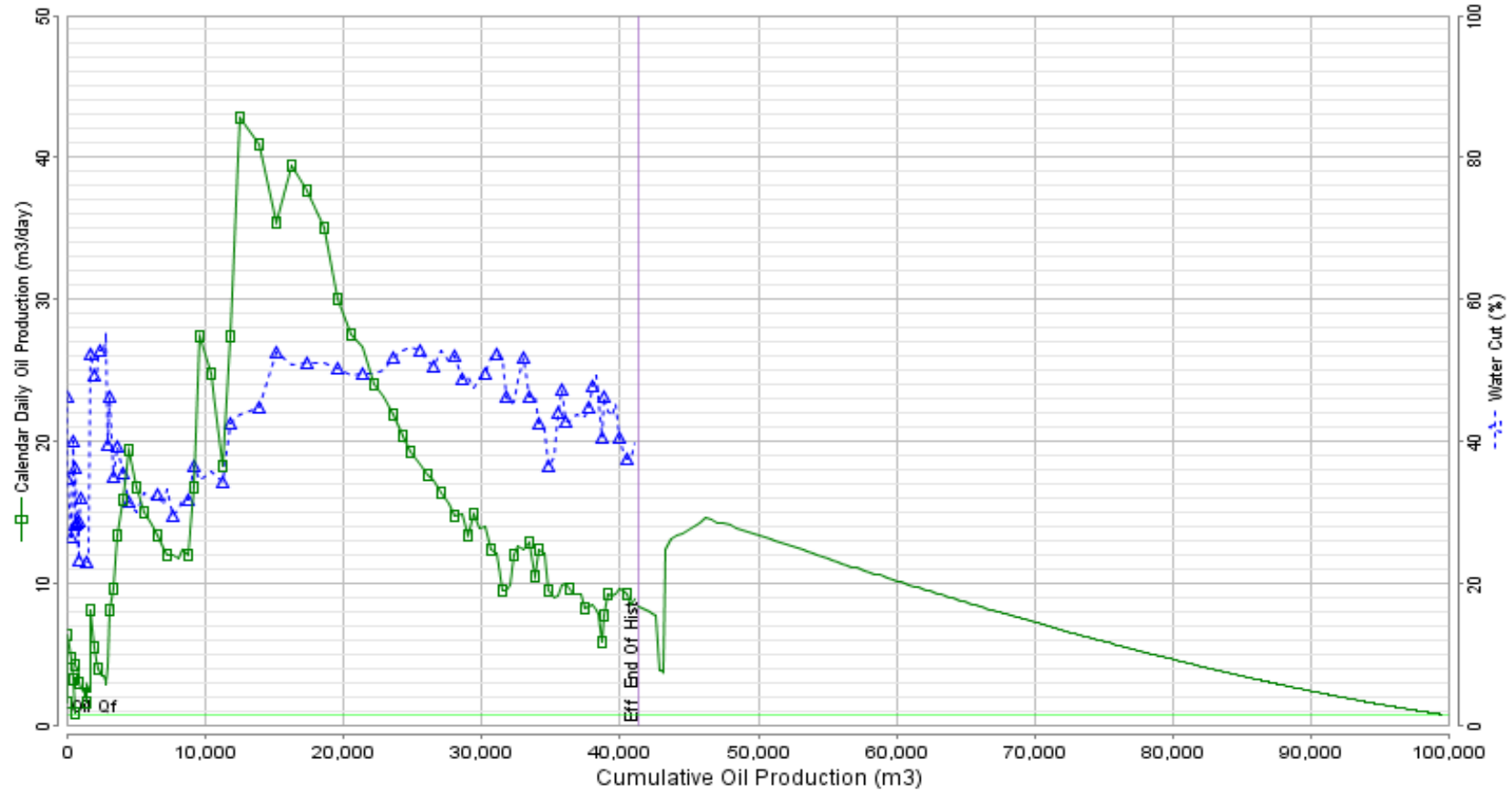

Cum Oil(m3):	41,354	Cum Gas(E3m3):	0	Cum Water(m3):	34,109	Cum Cond(m3):	0
Forecast Start:	04/01/2014	Calculation Type:	Undefined	Est. Cum Prod (m3):	41,354	Decline Exponent:	0.000
Forecast End:	10/24/2052	OVP (m3):	0	Remaining (m3):	58,086	Initial Decline (%/yr):	0.0
Initial Rate (m3):	8.4	Recovery Factor:	0.000				
Final Rate (m3):	0.8	Ult. Recoverable (m3):	99,441				

FIGURE NO. 12

Sinclair Water Injection System

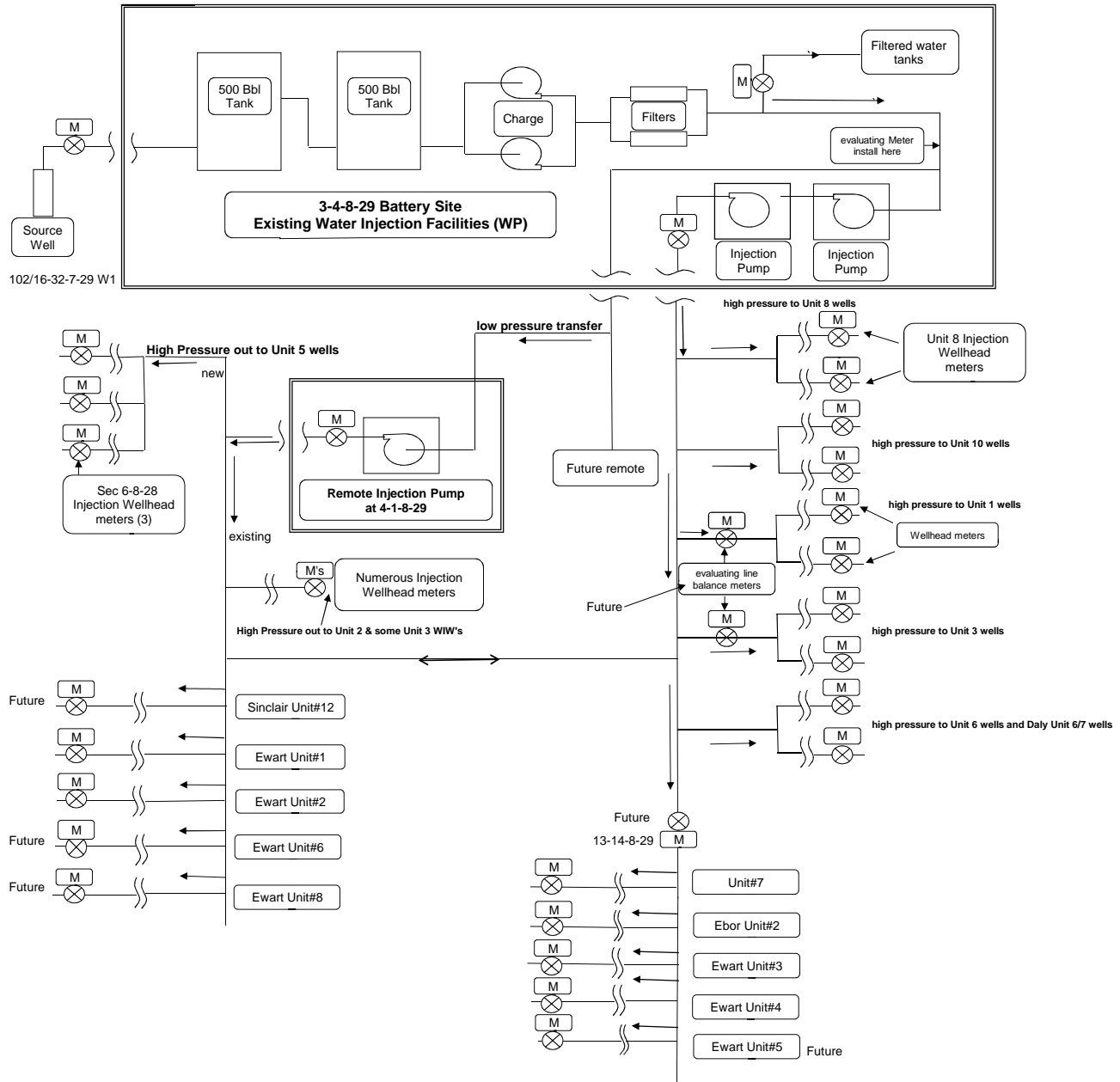

Ewart Unit No. 8

Proposed Injection Well Surface Piping P&ID

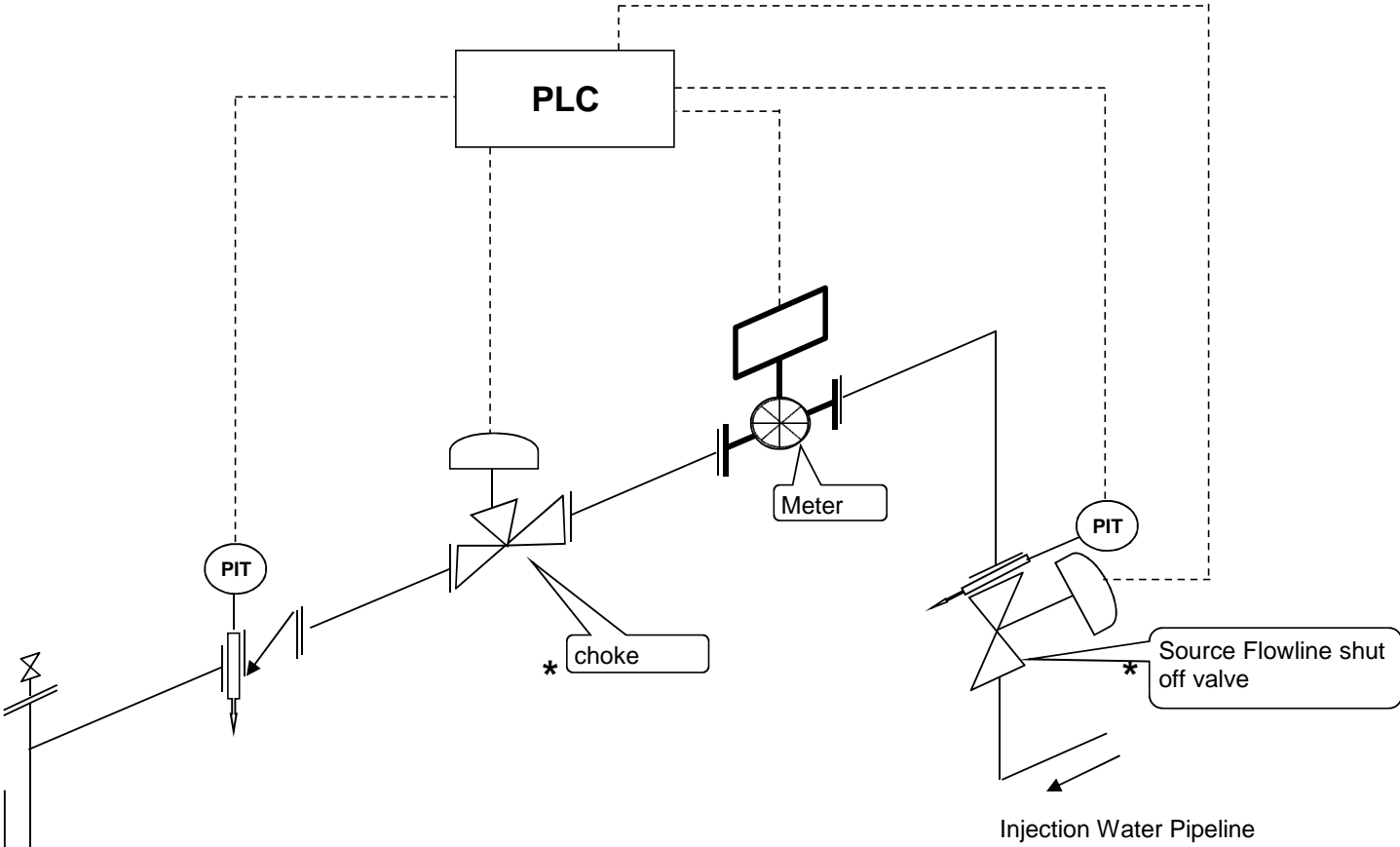

- * - metering, Injection Well master valve, source pipeline valve, rate control / choke are all standard
- dashed lines indicate future potential automation
- Piping and Flanges designed ANSI 600

Injection Well

Injection Water Pipeline

Ewart Unit No. 8

EOR Waterflood Project

Planned Corrosion Control Program **

Source Well

- Continuous downhole corrosion inhibition
- Continuous surface corrosion inhibitor injection
- Downhole scale inhibitor injection
- Corrosion resistant valves and internally coated surface piping

Pipelines

- Source well to 3-4-8-29 Water Plant – Fiberglass
- New High Pressure Pipeline to Unit 9 injection wells – 2000 psi high pressure Fiberglass

Facilities

- 3-4-8-29 Water Plant and New Injection Pump Station
 - Plant piping – 600 ANSI schedule 80 pipe, Fiberglass or Internally coated
 - Filtration – Stainless steel bodies and PVC piping
 - Pumping – Ceramic plungers, stainless steel disc valves
 - Tanks – Fiberglass shell, corrosion resistant valves

Injection Wellhead / Surface Piping

- Corrosion resistant valves and stainless steel and/or internally coated steel surface piping

Injection Well

- Casing cathodic protection where required
- Wetted surfaces coated downhole packer
- Corrosion inhibited water in the annulus between tubing / casing
- Internally coated tubing surface to packer
- Surface freeze protection of annular fluid
- Corrosion resistant master valve
- Corrosion resistant pipeline valve

Producing Wells

- Casing cathodic protection where required
- Downhole batch corrosion inhibition as required
- Downhole scale inhibitor injection as required

Figure 14

** subject to final design and engineering

EXHIBIT 'A': TRACT PARTICIPATION

Table 1

Proposed EWART UNIT NO. 8

Attached to and made part of an Agreement Entitled
Ewart Unit No. 8 - Unit Agreement

Tract No.	Working Interest			Royalty Interest		Tract Participation %
	Land Description	Owner	Share (%)	Owner	Share (%)	
1	LSD 1-20-7-28 WPM	Tundra Oil & Gas Partnership	100%	HER MAJESTY THE QUEEN IN RIGHT OF THE PROVINCE OF MANITOBA	100%	5.280734325
2	LSD 2-20-7-28 WPM	Tundra Oil & Gas Partnership	100%	HER MAJESTY THE QUEEN IN RIGHT OF THE PROVINCE OF MANITOBA	100%	5.526268814
3	LSD 3-20-7-28 WPM	Tundra Oil & Gas Partnership	100%	HER MAJESTY THE QUEEN IN RIGHT OF THE PROVINCE OF MANITOBA	100%	6.592644194
4	LSD 4-20-7-28 WPM	Tundra Oil & Gas Partnership	100%	HER MAJESTY THE QUEEN IN RIGHT OF THE PROVINCE OF MANITOBA	100%	8.852555857
5	LSD 5-20-7-28 WPM	Tundra Oil & Gas Partnership	100%	HER MAJESTY THE QUEEN IN RIGHT OF THE PROVINCE OF MANITOBA	100%	10.812821294
6	LSD 6-20-7-28 WPM	Tundra Oil & Gas Partnership	100%	HER MAJESTY THE QUEEN IN RIGHT OF THE PROVINCE OF MANITOBA	100%	7.461063080
7	LSD 7-20-7-28 WPM	Tundra Oil & Gas Partnership	100%	HER MAJESTY THE QUEEN IN RIGHT OF THE PROVINCE OF MANITOBA	100%	5.444426435
8	LSD 8-20-7-28 WPM	Tundra Oil & Gas Partnership	100%	HER MAJESTY THE QUEEN IN RIGHT OF THE PROVINCE OF MANITOBA	100%	3.263779574
9	LSD 9-20-7-28 WPM	Tundra Oil & Gas Partnership	100%	HER MAJESTY THE QUEEN IN RIGHT OF THE PROVINCE OF MANITOBA	100%	2.915374667
10	LSD 10-20-7-28 WPM	Tundra Oil & Gas Partnership	100%	HER MAJESTY THE QUEEN IN RIGHT OF THE PROVINCE OF MANITOBA	100%	2.603677224
11	LSD 11-20-7-28 WPM	Tundra Oil & Gas Partnership	100%	HER MAJESTY THE QUEEN IN RIGHT OF THE PROVINCE OF MANITOBA	100%	8.187345694
12	LSD 12-20-7-28 WPM	Tundra Oil & Gas Partnership	100%	HER MAJESTY THE QUEEN IN RIGHT OF THE PROVINCE OF MANITOBA	100%	10.464706094
13	LSD 13-20-7-28 WPM	Tundra Oil & Gas Partnership	100%	HER MAJESTY THE QUEEN IN RIGHT OF THE PROVINCE OF MANITOBA	100%	9.313334194
14	LSD 14-20-7-28 WPM	Tundra Oil & Gas Partnership	100%	HER MAJESTY THE QUEEN IN RIGHT OF THE PROVINCE OF MANITOBA	100%	7.788330433
15	LSD 15-20-7-28 WPM	Tundra Oil & Gas Partnership	100%	HER MAJESTY THE QUEEN IN RIGHT OF THE PROVINCE OF MANITOBA	100%	2.598375563
16	LSD 16-20-7-28 WPM	Tundra Oil & Gas Partnership	100%	HER MAJESTY THE QUEEN IN RIGHT OF THE PROVINCE OF MANITOBA	100%	2.894562556

100.00000000

TABLE NO. 2: TRACT FACTOR CALCULATIONS
TRACT FACTORS BASED ON OIL-IN-PLACE (OOIP) LESS CUMULATIVE OIL PRODUCED METHOD

PROPOSED EWART UNIT NO. 8							
LSD-SEC	TWP-RGE	UWI	OOIP (m3)	Hz Allocated Cum Prodn Mar 2014 (m3)	Vertical Cum Prodn Mar 2014 (m3)	OOIP Minus Cum Oil Prodn (m3)	Tract Factor (%)
01-20	007-28W1	100/01-20-007-28W1/0	31737	0	1389	30348	5.280734325
02-20	007-28W1	100/02-20-007-28W1/0	32552	0	793	31759	5.526268814
03-20	007-28W1	100/03-20-007-28W1/0	39982	19	2076	37887	6.592644194
04-20	007-28W1	100/04-20-007-28W1/0	54949	77	3998	50875	8.852555857
05-20	007-28W1	100/05-20-007-28W1/0	65726	933	2654	62140	10.812821294
06-20	007-28W1	100/06-20-007-28W1/0	44800	1922	0	42878	7.461063080
07-20	007-28W1	100/07-20-007-28W1/0	33227	1939	0	31288	5.444426435
08-20	007-28W1	100/08-20-007-28W1/0	20637	1880	0	18757	3.263779574
09-20	007-28W1	100/09-20-007-28W1/0	19133	2378	0	16754	2.915374667
10-20	007-28W1	100/10-20-007-28W1/0	17330	2367	0	14963	2.603677224
11-20	007-28W1	100/11-20-007-28W1/0	49419	2367	0	47052	8.187345694
12-20	007-28W1	100/12-20-007-28W1/0	64750	839	3772	60139	10.464706094
13-20	007-28W1	100/13-20-007-28W1/0	59159	1584	4053	53523	9.313334194
14-20	007-28W1	100/14-20-007-28W1/0	47437	2679	0	44759	7.788330433
15-20	007-28W1	100/15-20-007-28W1/0	17628	2695	0	14933	2.598375563
16-20	007-28W1	100/16-20-007-28W1/0	17577	738	204	16635	2.894562556
TOTAL			616042	22417	18937	574688	100.000000000

TABLE NO. 3

Proposed Ewart Unit 8 Well List

<i>UWI</i>	<i>License Number</i>	<i>Type</i>	<i>Pool Name</i>	<i>Producing Zone</i>	<i>Mode</i>	<i>On Prod Date</i>	<i>Prod Date</i>	<i>Cal Dly Oil (m3/d)</i>	<i>Monthly Oil (m3)</i>	<i>Cum Prd Oil (m3)</i>	<i>Cal Dly Water (m3/d)</i>	<i>Monthly Water (m3)</i>	<i>Cum Prd Water (m3)</i>	<i>WCT (%)</i>	
100/01-20-007-28W1/0	006683	Vertical	BAKKEN-THREE FORKS B	BAKKEN	Producing	10/1/2008	2014-03	0.6	18.8	1389.3	0.5	15.4	1679.4	45	
100/02-20-007-28W1/0	006684	Vertical	BAKKEN-THREE FORKS B	BAKKEN	Producing	8/1/2008	2014-03	0.4	12.3	792.7	0.3	8.4	1232.7	40.6	
100/03-20-007-28W1/0	006000	Vertical	BAKKEN-THREE FORKS B	BAKKEN	Producing	8/1/2006	2014-03	0.3	10.6	2075.9	0.1	4.4	1846.3	29.3	
100/04-20-007-28W1/0	006326	Vertical	BAKKEN-THREE FORKS B	THREEFK,BAKKEN	Producing	9/1/2007	2014-03	0.8	26.2	3997.5	0.2	7.5	1613.7	22.3	
102/05-20-007-28W1/0	006392	Vertical	BAKKEN-THREE FORKS B	BAKKEN	Producing	9/1/2007	2014-03	0.2	4.8	2653.5	0.2	4.9	1047	50.5	
100/08-20-007-28W1/0	006880	Horizontal	BAKKEN-THREE FORKS B	BAKKEN	Producing	2/1/2009	2014-03	2.6	79.7	6769.8	1.7	51.2	8318.3	39.1	
100/09-20-007-28W1/0	006747	Horizontal	BAKKEN-THREE FORKS B	TORQUAY	Producing	10/1/2008	2014-03	1.7	52.9	7940.5	1.9	60.1	7419.5	53.2	
100/12-20-007-28W1/0	006253	Vertical	BAKKEN-THREE FORKS B	BAKKEN	Producing	6/1/2007	2014-03	0.6	18.7	3771.7	0.3	10.1	1427.4	35.1	
100/13-20-007-28W1/0	005351	Vertical	BAKKEN-THREE FORKS B	BAKKEN	Producing	12/1/2004	2014-03	0.5	14.6	4053	0.1	4.1	1561.4	21.9	
100/16-20-007-28W1/00	006001	Vertical	BAKKEN-THREE FORKS B	BAKKEN	Producing	8/1/2006	2014-03	0	0	203.8	0	0	931.5	0	
102/16-20-007-28W1/0	006881	Horizontal	BAKKEN-THREE FORKS B	BAKKEN	Producing	2/1/2009	2014-03	1.2	36.2	7706.7	0.5	16	7031.7	30.7	
											41354.4			34108.9	

TABLE NO. 4: OOIP Calculation

UWI	MBKKN OOIP 0.5 md (m3)	Lyleton UA OOIP 1.0 md (m3)	Lyleton LA OOIP 1.0 md (m3)	Lyleton B OOIP 0.5 md (m3)	TOTAL OOIP GLJ Cut-Offs (m3)	MB Pih 0.5 md	UA Pih 1.0 md	LA Pih 1.0 md	LB Pih 0.5 md
01-20-007-28W1M	4,315	11,255	3,895	12,272	31,737	0.045998	0.108813	0.040788	0.128527
02-20-007-28W1M	4,634	18,462	3,749	5,707	32,552	0.052452	0.178487	0.039260	0.059771
03-20-007-28W1M	5,793	28,580	2,510	3,099	39,982	0.061746	0.276299	0.026285	0.032458
04-20-007-28W1M	6,302	38,587	4,663	5,397	54,949	0.066734	0.373045	0.048835	0.056523
05-20-007-28W1M	4,492	48,267	6,008	6,960	65,726	0.051831	0.466622	0.062919	0.072893
06-20-007-28W1M	4,206	31,034	4,480	5,079	44,800	0.049324	0.300026	0.046922	0.053198
07-20-007-28W1M	4,227	17,889	3,817	7,294	33,227	0.048290	0.172942	0.039976	0.076396
08-20-007-28W1M	4,886	0	4,128	11,623	20,637	0.053989	0.000000	0.043231	0.121735
09-20-007-28W1M	4,984	0	5,039	9,110	19,133	0.056010	0.000000	0.052774	0.095409
10-20-007-28W1M	4,125	0	5,381	7,825	17,330	0.045795	0.000000	0.056355	0.081950
11-20-007-28W1M	3,804	30,830	6,661	8,124	49,419	0.043353	0.298052	0.069761	0.085086
12-20-007-28W1M	3,912	43,888	7,249	9,702	64,750	0.044460	0.424288	0.075916	0.101608
13-20-007-28W1M	3,131	36,789	7,634	11,606	59,159	0.035467	0.355660	0.079949	0.121554
14-20-007-28W1M	3,148	27,243	7,459	9,588	47,437	0.036367	0.263372	0.078115	0.100413
15-20-007-28W1M	3,650	0	6,150	7,828	17,628	0.040267	0.000000	0.064415	0.081980
16-20-007-28W1M	4,658	0	5,539	7,379	17,577	0.052741	0.000000	0.058010	0.077286

616,042

3,874,790 BBL

TABLE NO. 5

Ewart Unit 8 - Section 20-007-28W1M
Middle Bakken/Three Forks Fm (Lyleton) Rock and Fluid Properties

Formation Pressure		9,400 kPa @ -452 mSS	Initial Average Reservoir Pressure
Formation Temperature		32°C	
Saturation Pressure		2034 kPa	Bubble Point
GOR		6-10 m ³ /m ³	Gas-Oil Ratio
API Oil Gravity		36-38	
Swi (fraction)		0.4	Initial Water Saturation
Produced Water Sp. Gr.		1.11	
Produced Water pH		7.1-7.3	
Produced Water TDS (mg/L)		150,000-156,000	
Wettability		Moderately oil-wet	
Average Air Permeability	Middle Bakken	0.902	Wt. Average Core Data
	Lyleton A	0.834	(kmax>1 mD)
	Lyleton B	1.399	
Average Porosity (Fraction)	Middle Bakken	0.148	Wt. Average Core Data
	Lyleton A	0.148	(kmax>1 mD)
	Lyleton B	0.152	

Wt Average from all MBKKN/Lyleton Cores in Section 29-7-28W1M plus 1 section around Section 29

Table No. 6: Ewart Unit No. 8 Project Schedule

Timing	Injectors			Producer
	Drilled	Future	Conversion	Future
Q3 2014				
Q4 2014			2	
Q1 2015				1
Q2 2015				
Q3 2015				
Q4 2015				
Q1 2016				

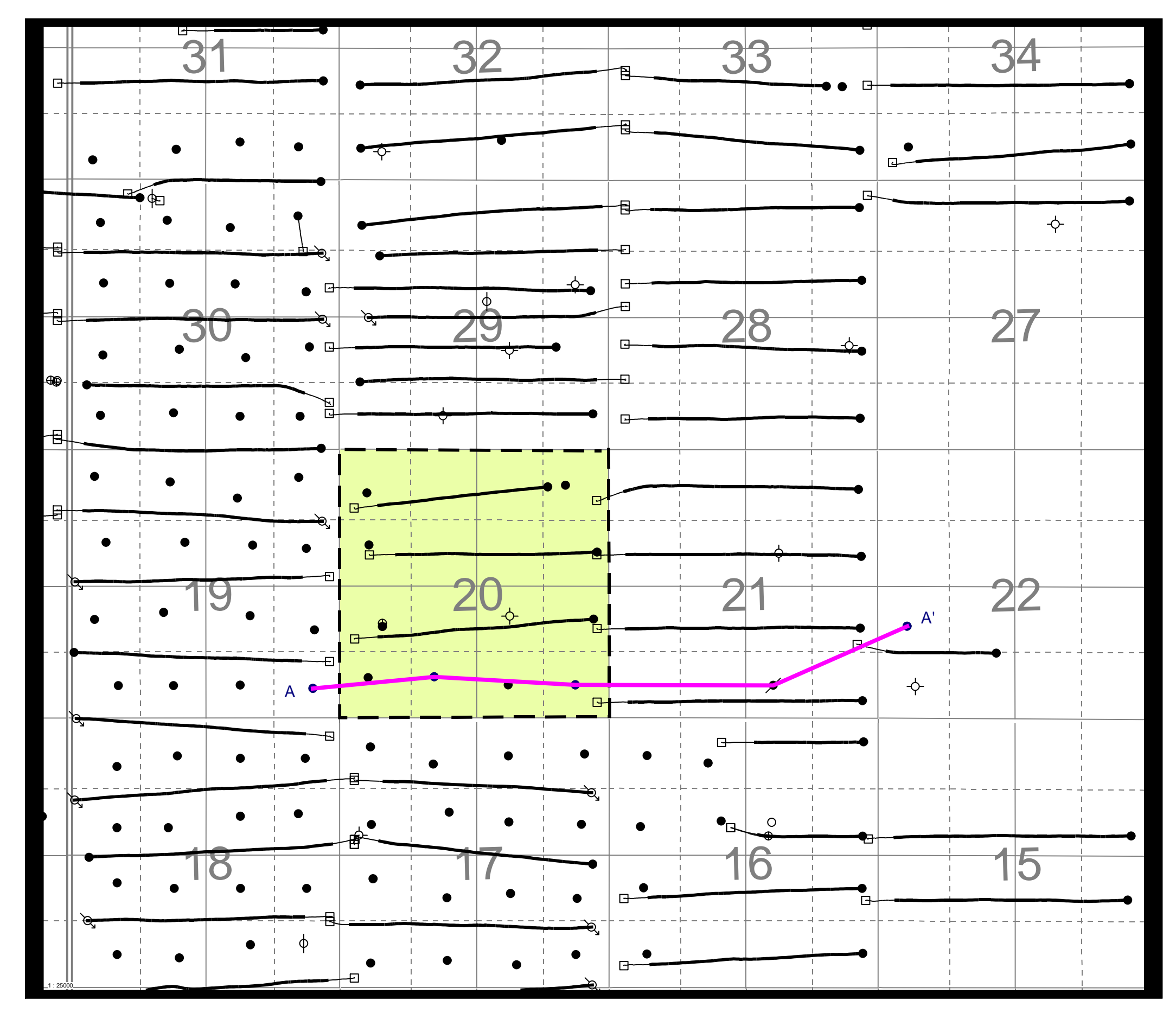
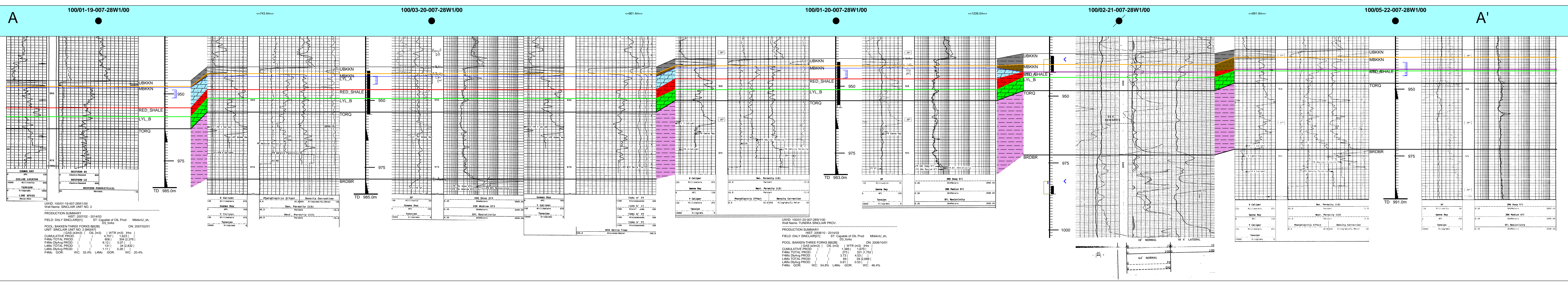

Tundra Oil and Gas Ltd

Structural Cross Section A - A'

Proposed Ewart Unit 8

APPENDIX 1

Licensed to: Tundra Oil and Gas Ltd

Date: 2014/05/23	By: Hackert
Datum: Sea Level	Ref: 0.0 (m)
Interval: From UBKKN to BRDBR	Scale = 1:480

geoscout
www.geoscout.com

R29

R28W1

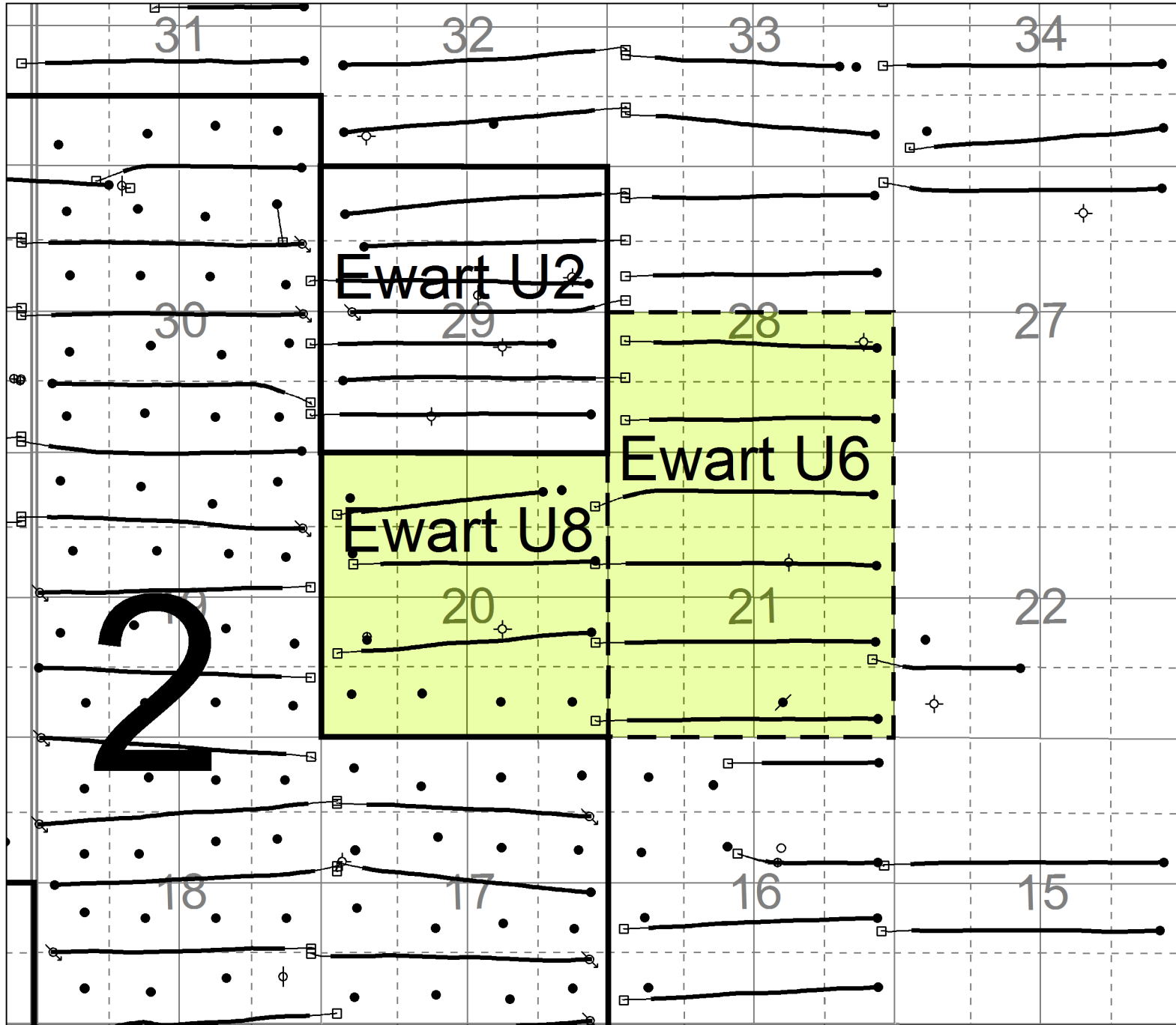

R29

R28W1

Tundra Oil & Gas Partnership
 EWART UNIT No. 8
 Offsetting Units
 APPENDIX 2

gPDS/SCOUT	Rev: 1.0	Date: 2014/05/29
Scale: 1:32000	Drawn: Sinclair	Plot:

R29

R28W1

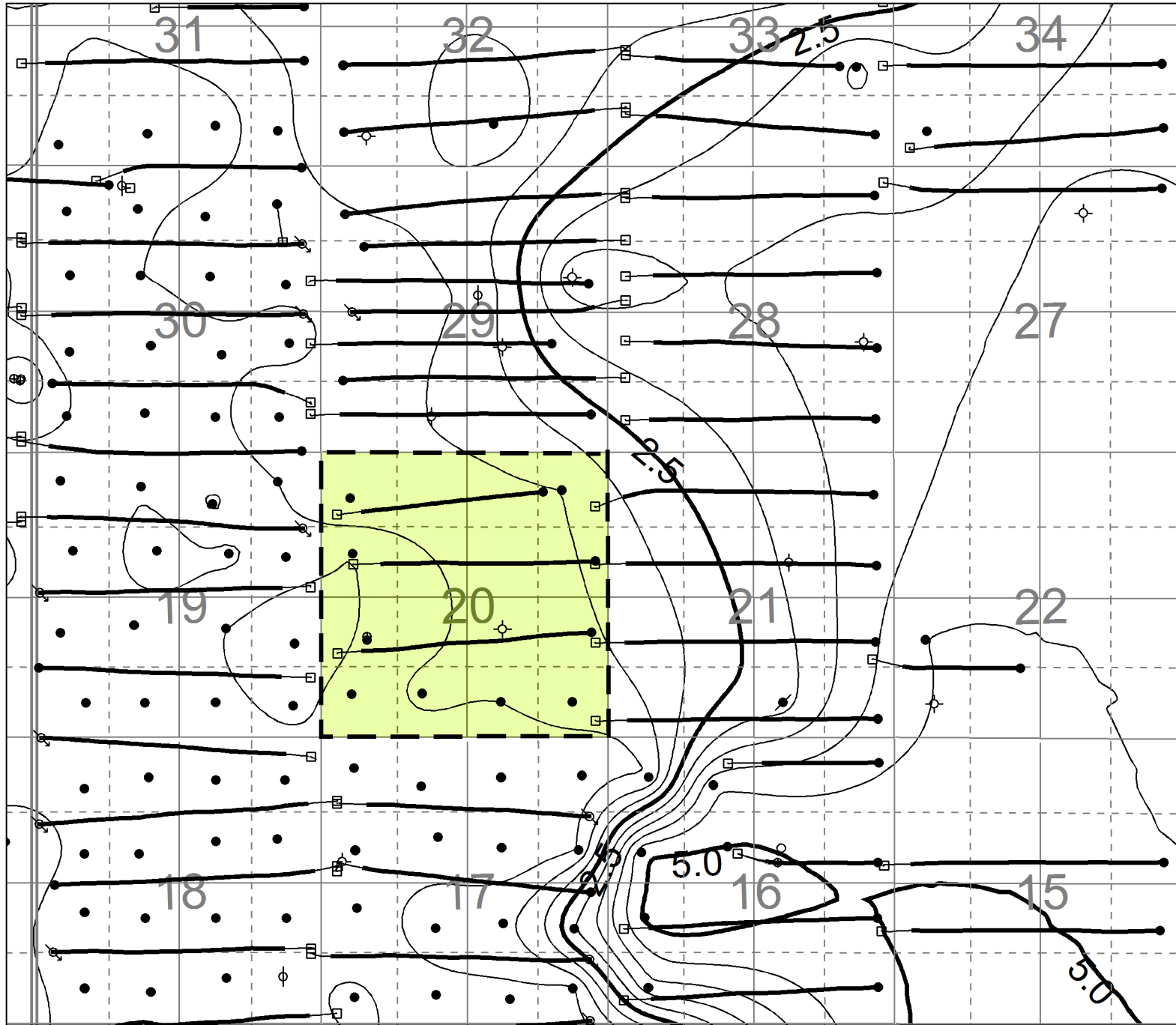

T7

T7

R29

R28W1

Tundra Oil & Gas Partnership		
EWART UNIT No. 8		
Middle Bakken Isopach CI=0.5m		
APPENDIX 3		
<small>Interests: Tundra Oil & Gas LP</small>		
<small>By: Haver</small>	<small>Date: 2016/02/21</small>	
<small>Scale: 1:10000</small>	<small>Project: 2016-08</small>	<small>Drawn: [unclear]</small>

R29

R28W1

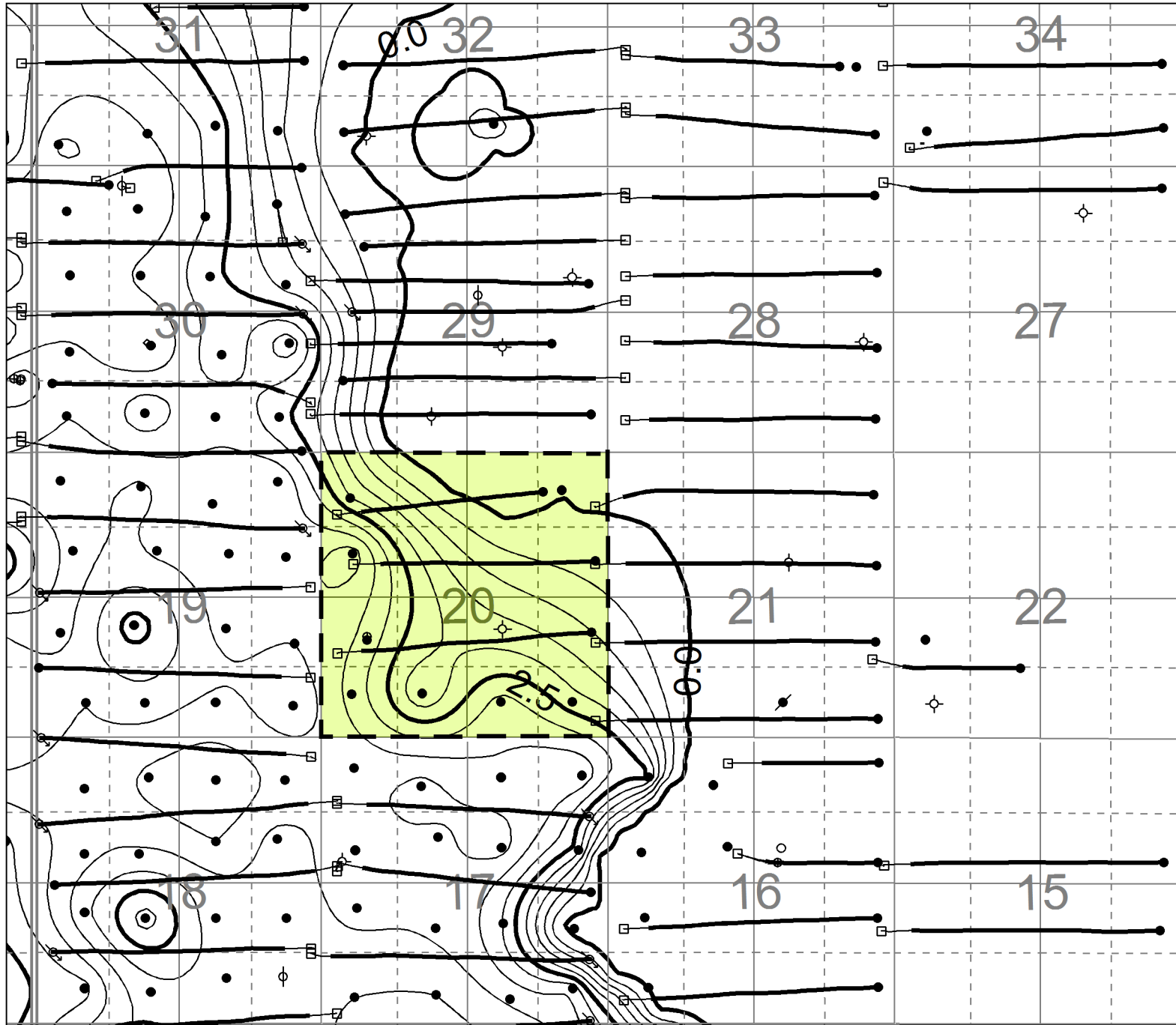

T7

T7

R29

R28W1

Tundra Oil & Gas Partnership
 EWART UNIT No. 8
 Lyleton Upper A Isopach CI=0.5m
 APPENDIX 4
 Licensed to: Tundra Oil and Gas Ltd.
 Date: 11/06/2014
 Scale: 1:10000
 Project: SCS-000-001

R29

R28W1



T7

T7

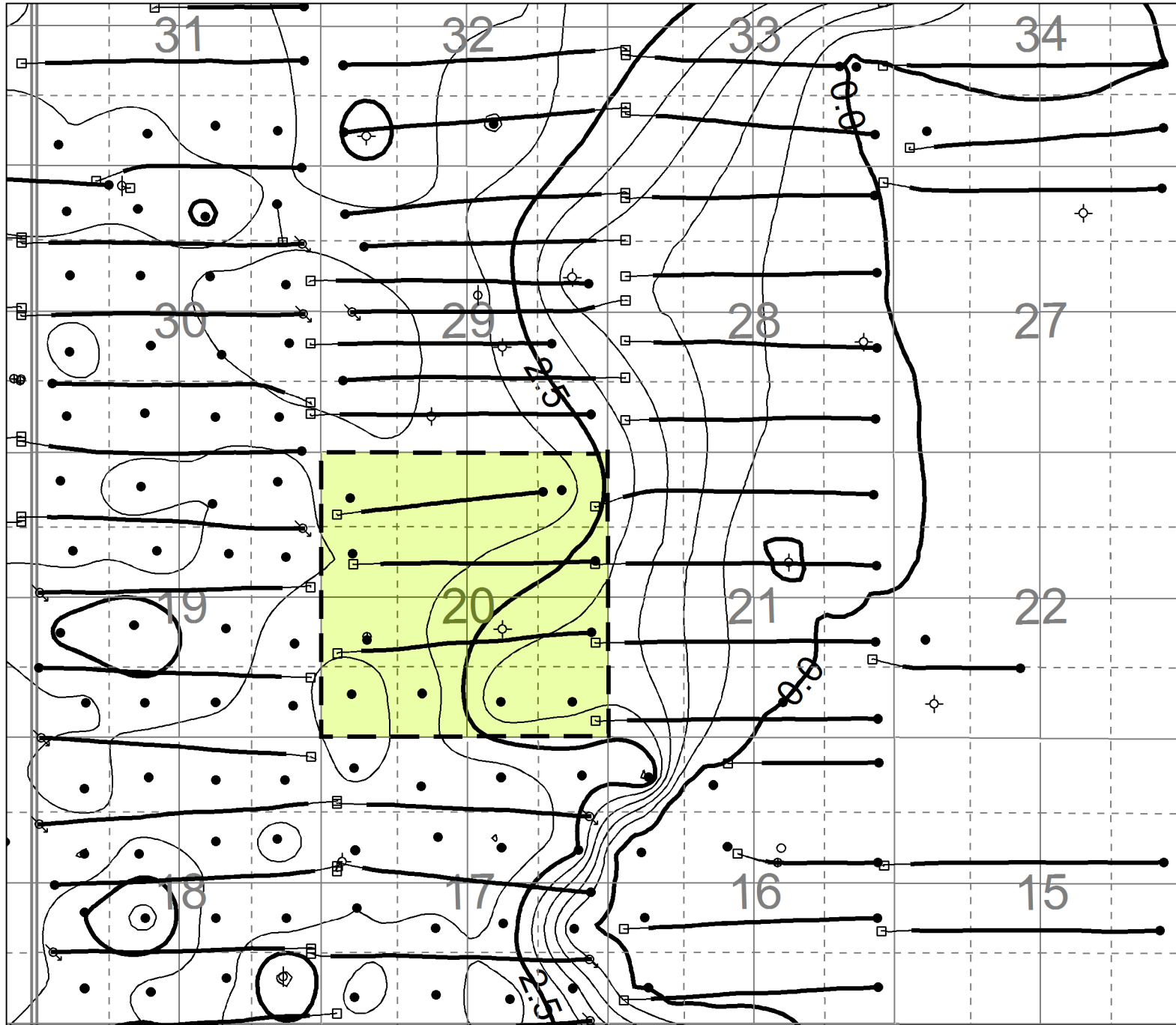

R29

R28W1

Tundra Oil & Gas Partnership
 EWART UNIT No. 8
 Lyleton Lower A Isopach CI=0.5m
 APPENDIX 5
 Licensed to: Tundra Oil and Gas Ltd.
 Date: 11/09/2014
 Scale: 1:10000
 Project: SGP-001-01

R29

R28W1

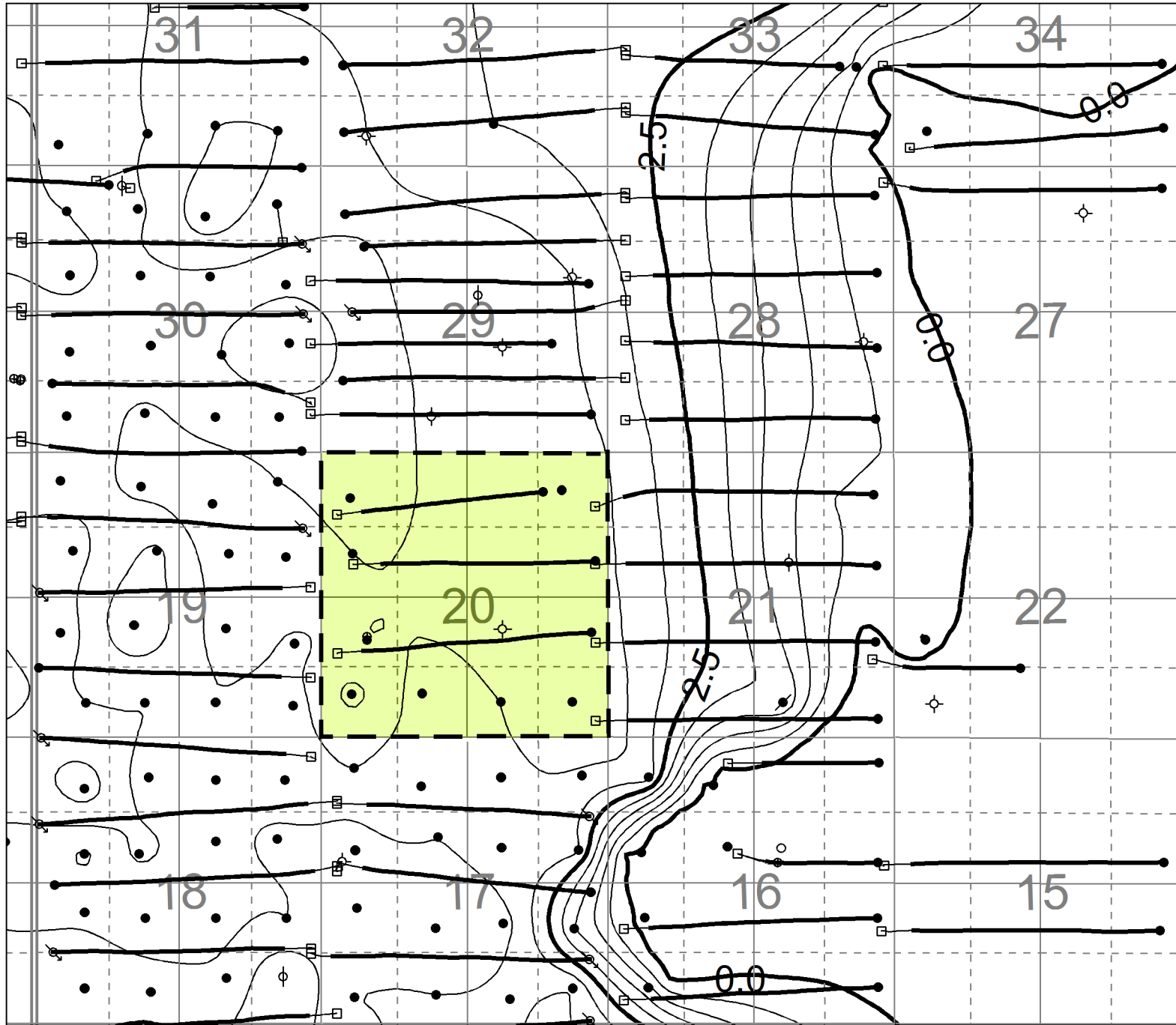

T7

T7

R29

R28W1

Tundra Oil & Gas Partnership
 EWART UNIT No. 8
 Red Shale Isopach CI=0.5m
 APPENDIX 6
Illustration: Tundra Oil and Gas Ltd.

By: HANCOCK Date: 2011/05/24
 Scale: 1:125000 Project: SPTW-0411

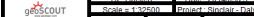

R29

R28W1

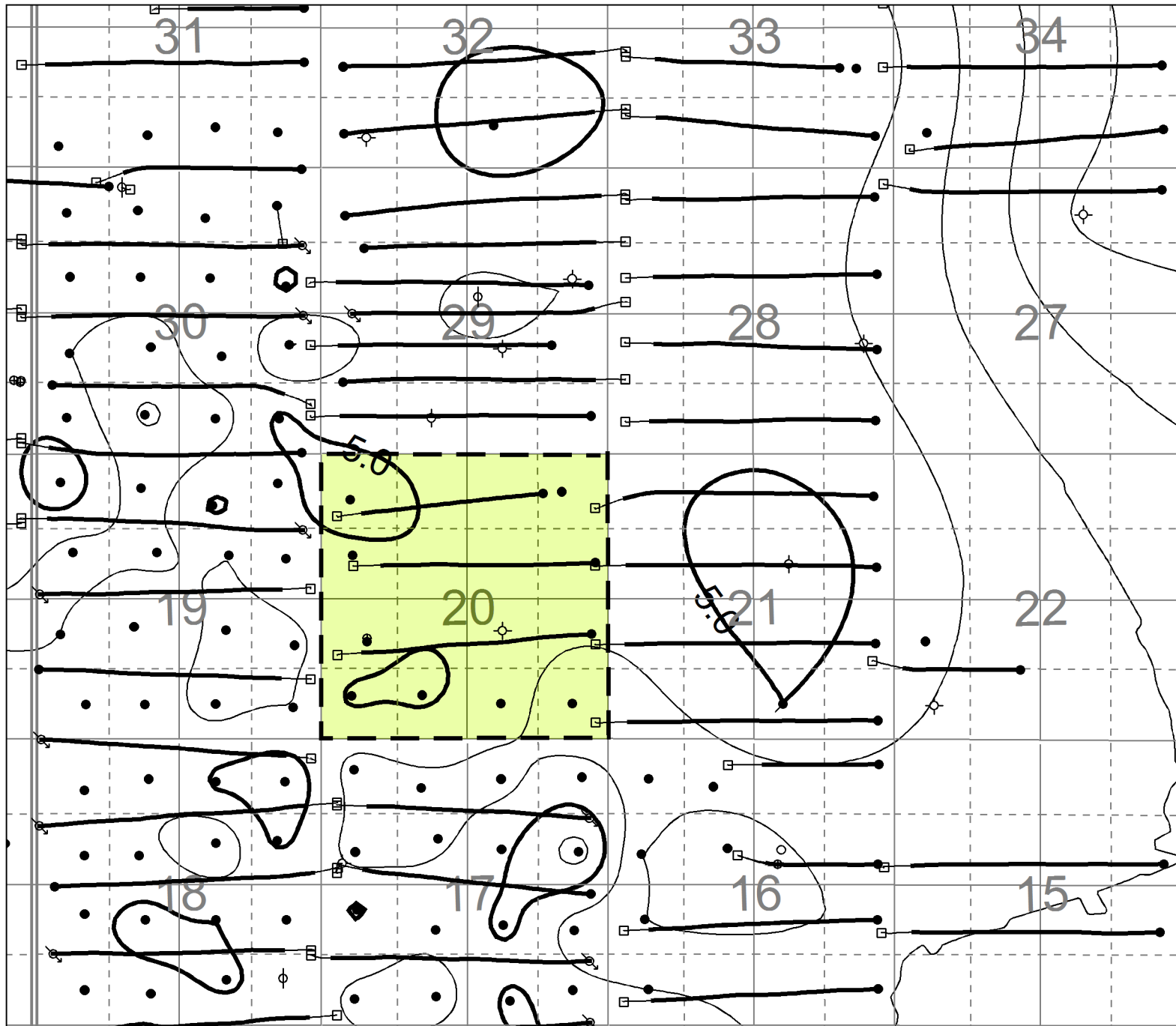

T7

T7

R29

R28W1

Tundra Oil & Gas Partnership		
EWART UNIT No. 8		
Lyleton B Isopach CI=0.5m		
APPENDIX 7		
<small>©2014 Tundra Oil and Gas Ltd.</small>		
<small>gPESCOUT</small>	<small>By: HANCOCK</small>	<small>DATE: 2014/05/21</small>
<small>2014-05-21 10:00</small>	<small>2014-05-21 10:00</small>	<small>2014-05-21 10:00</small>

R29

R28W1



T7

T7

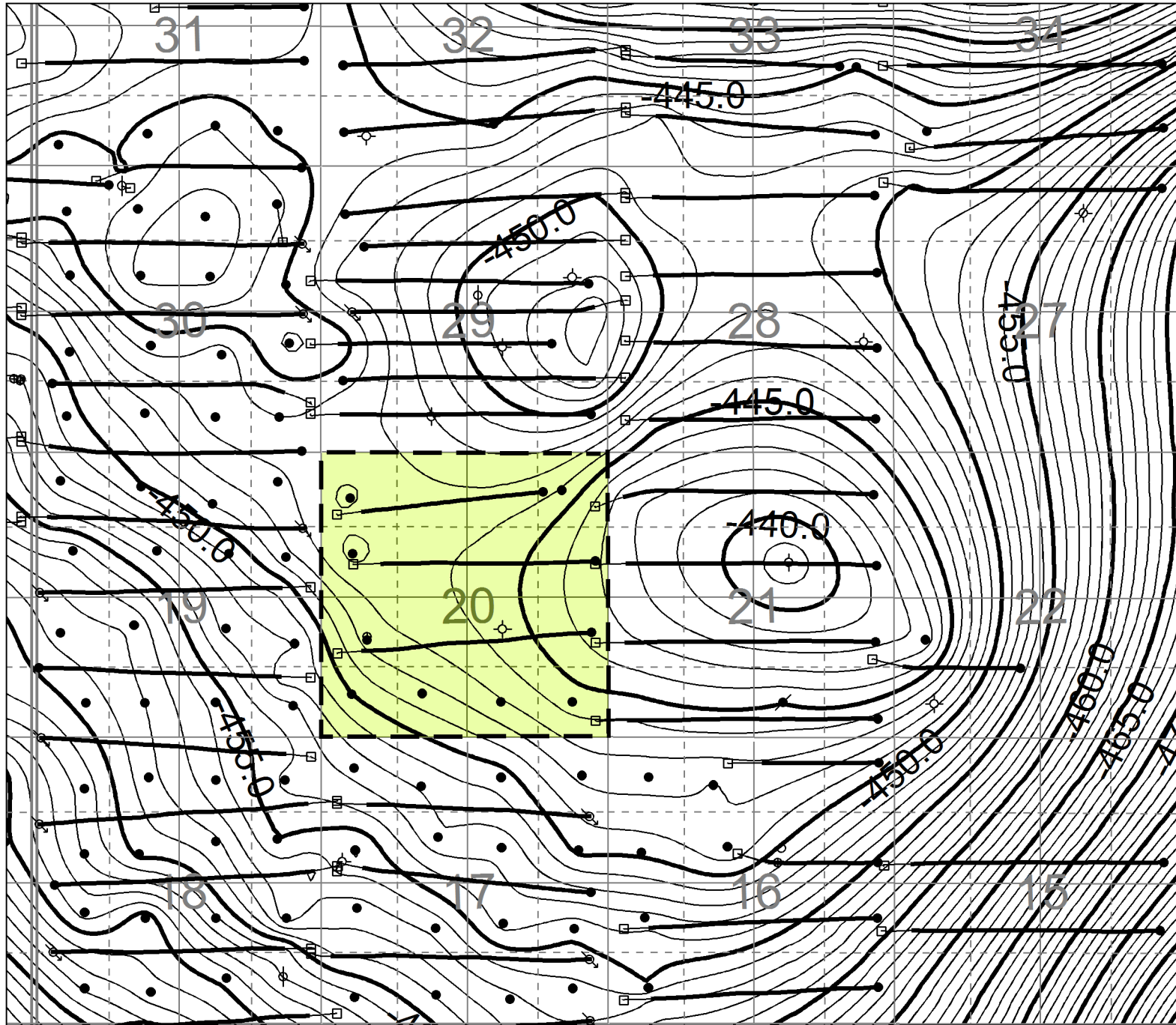

R29

R28W1

Tundra Oil & Gas Partnership
 EWART UNIT No. 8
 Middle Bakken Structure CI=1m
 APPENDIX 8
 Licensed by: Tundra Oil and Gas Ltd
 By: [Signature] Date: 09/11/2023
 Scale: 1:25000 Project: 2023-01-01

R29

R28W1

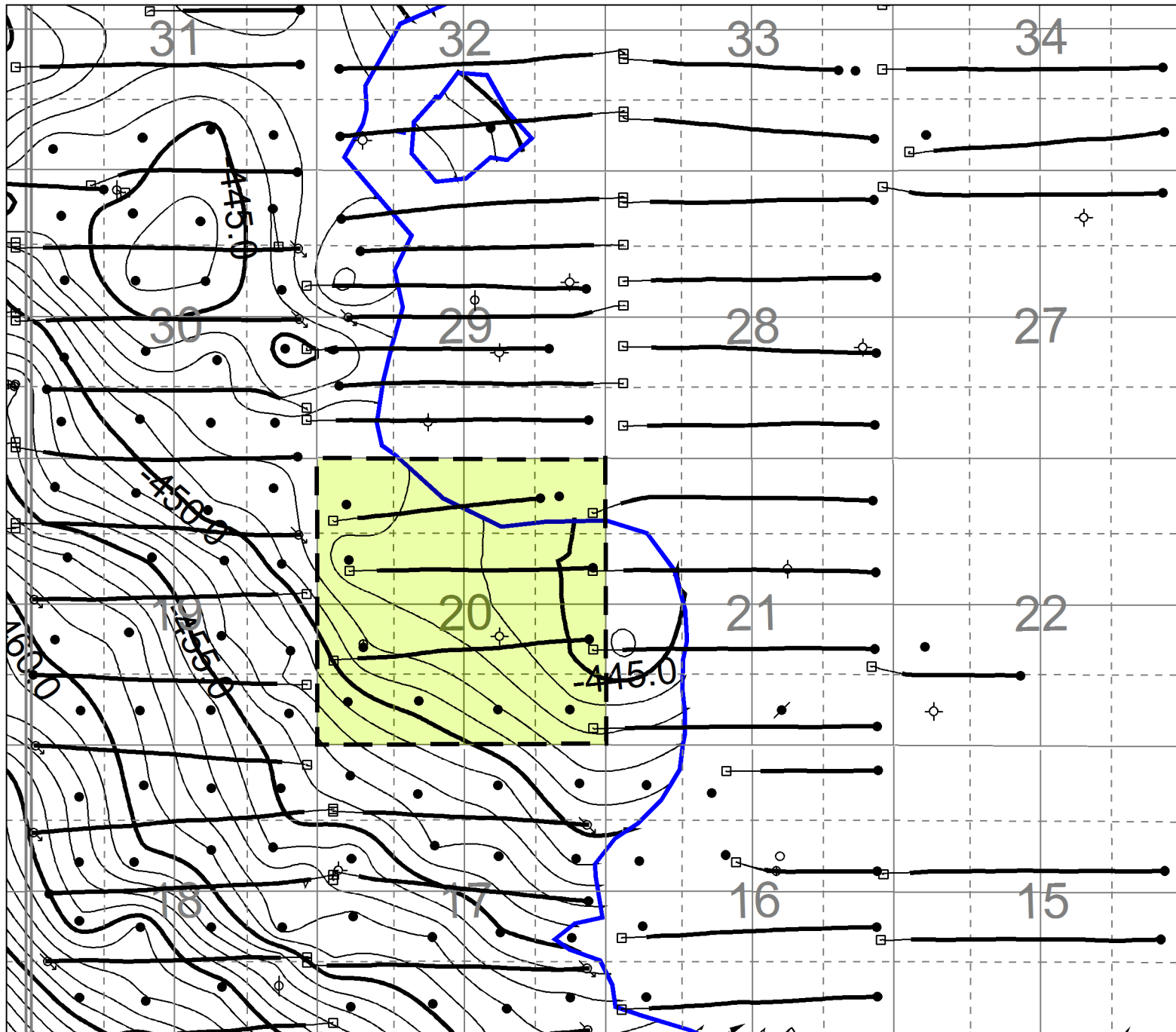

T7

T7

R29

R28W1

Tundra Oil & Gas Partnership
 EWART UNIT No. 8
 Lyleton Upper A Structure CI=1m
 APPENDIX 9
 Licensed to: Tundra Oil & Gas Partnership
 By: 11/20/2014 Date: 2014/05/26
 Scale: 1:50000 Project: Structure Data
 gSCOUT

R29

R28W1

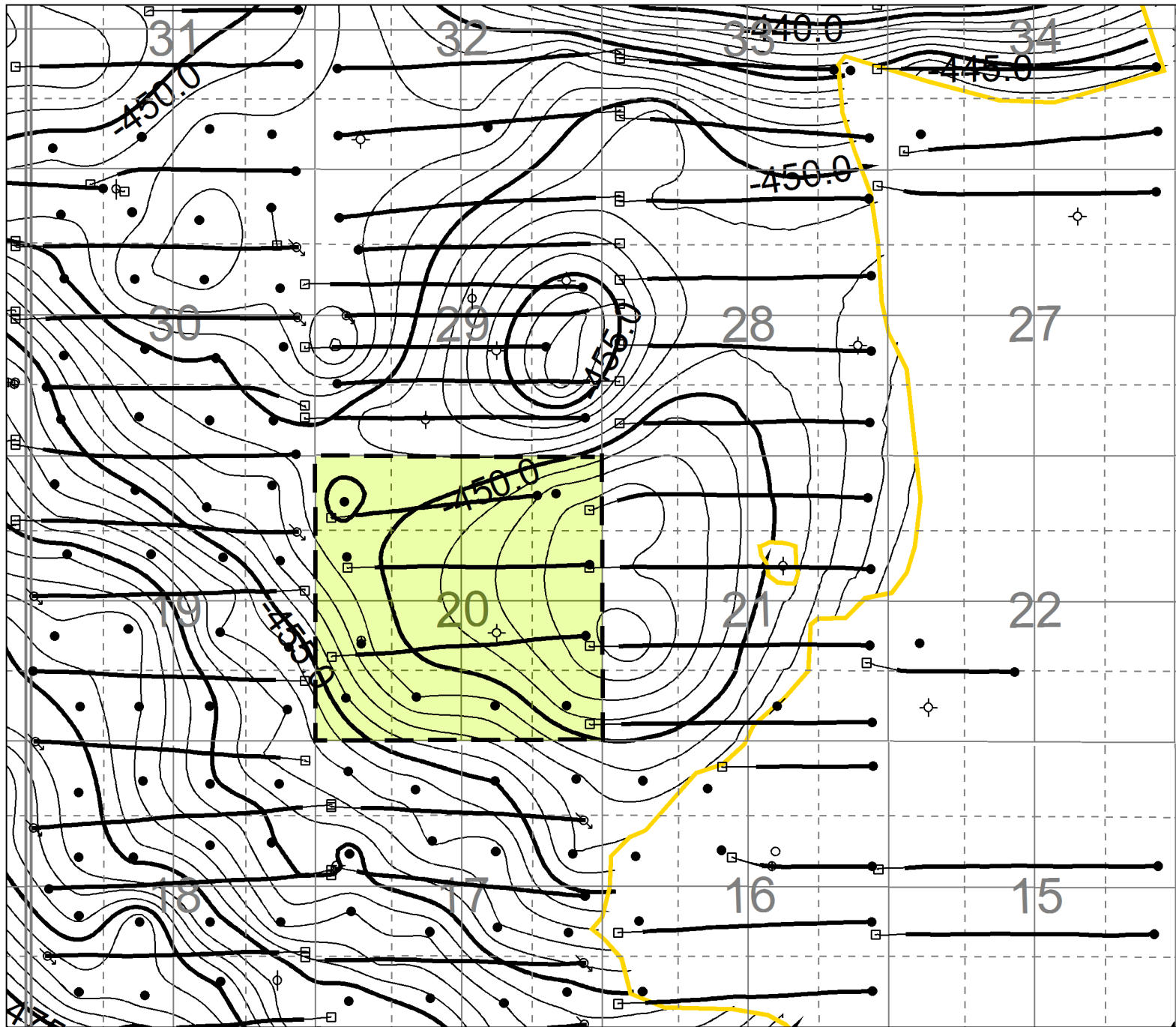

T7

T7

R29

R28W1

Tundra Oil & Gas Partnership
 EWART UNIT No. 8
 Lyleton Lower A Structure CI=1m
 APPENDIX 10
 Licensed to: Tundra Oil & Gas Partnership
 By: 11/20/2010 Date: 2011/05/20
 Scale: 1:50000 Project: Structure Data
 gBCOUT

R29

R28W1

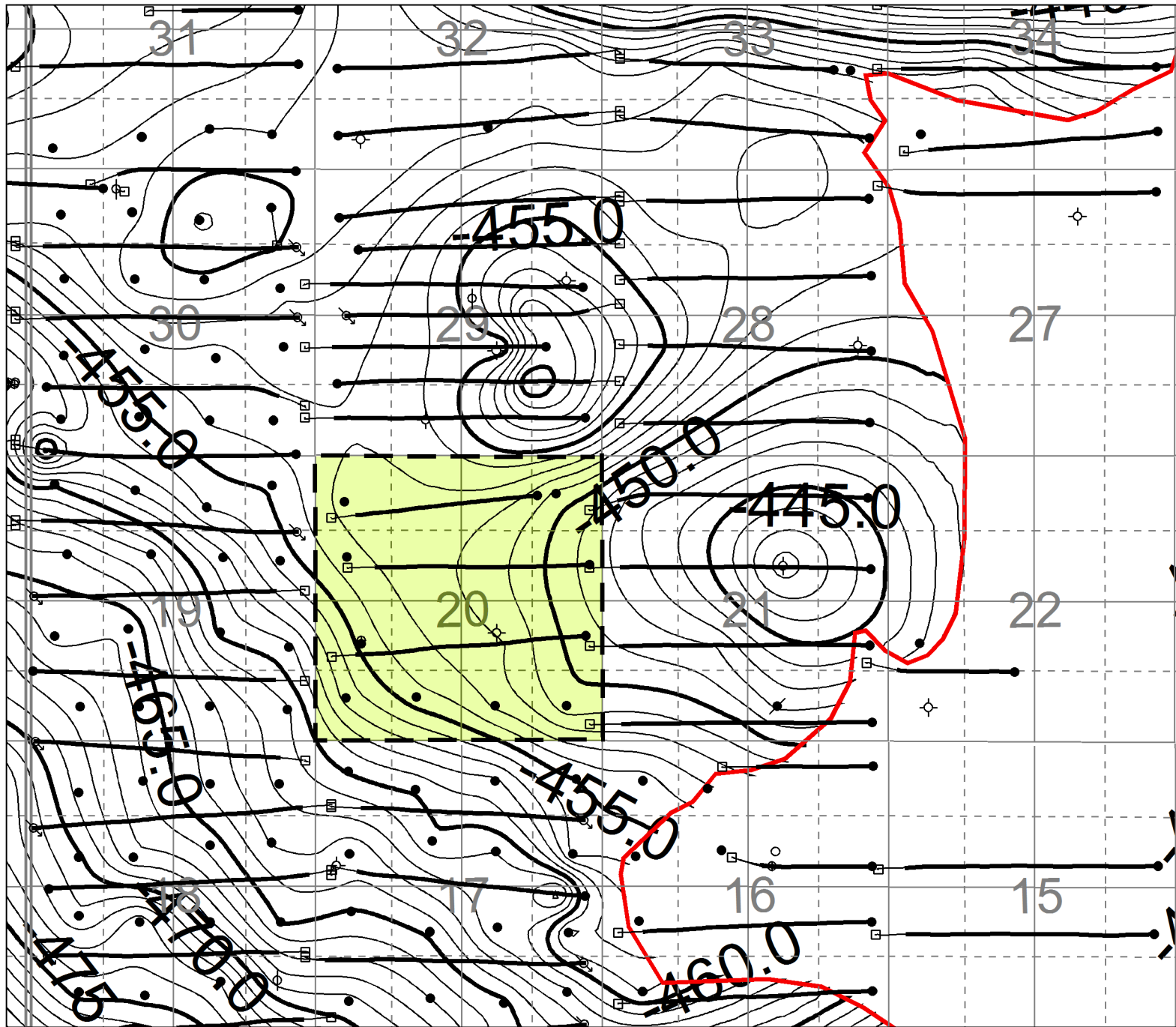

T7

T7

R29

R28W1

Tundra Oil & Gas Partnership
 EWART UNIT No. 8
 Red Shale Structure CI=1m
 APPENDIX 11
License to: Tundra Oil & Gas Partnership

By: [Signature]	Date: 2014/09/24
Scale: 1:25000	Drawn: [Signature]

gSCOUT

R29

R28W1

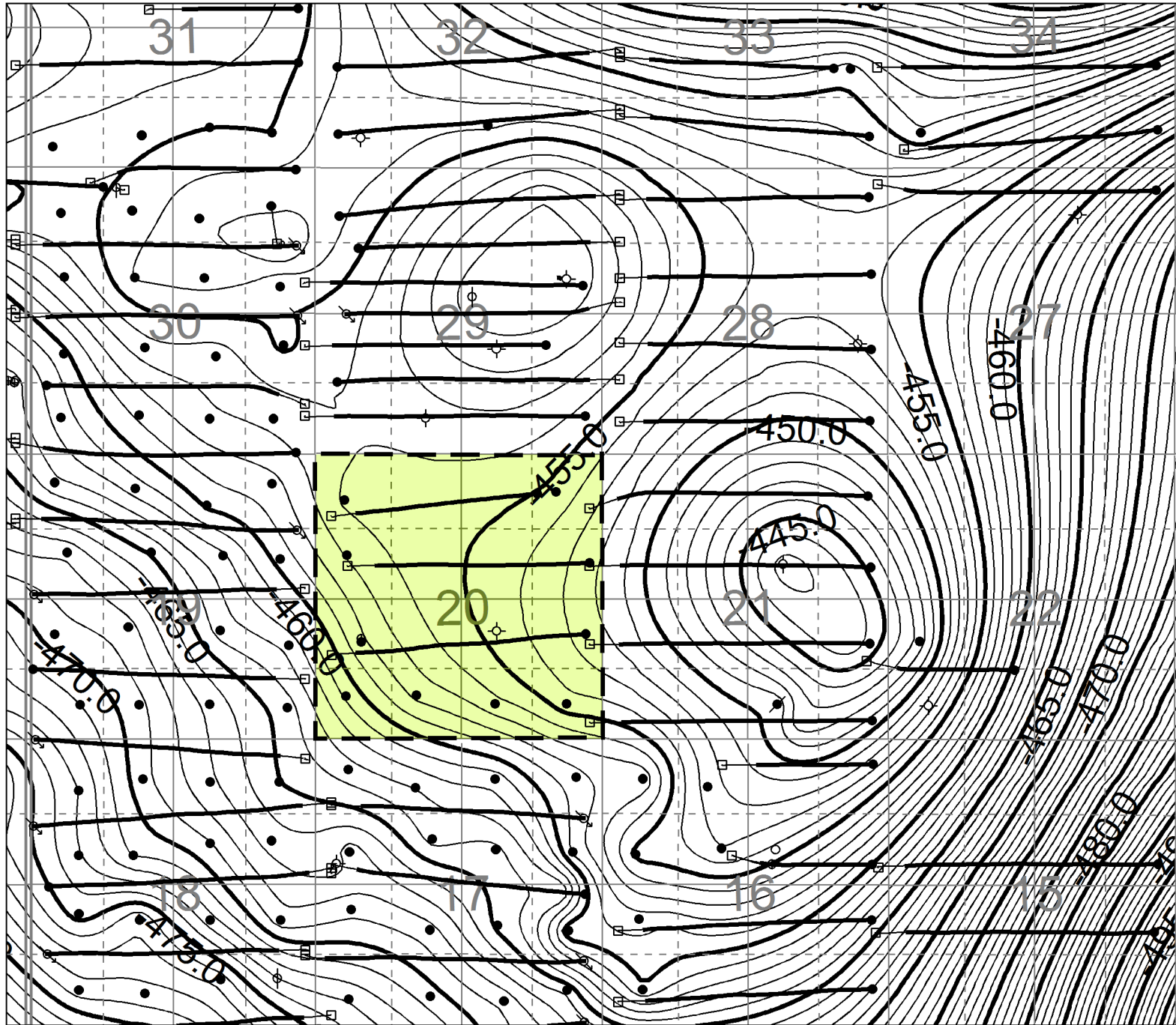

T7

T7

R29

R28W1

Tundra Oil & Gas Partnership
 EWART UNIT No. 8
 Lyleton B Structure CI=1m
 APPENDIX 12
Copyright © 2010 Tundra Oil & Gas Partnership

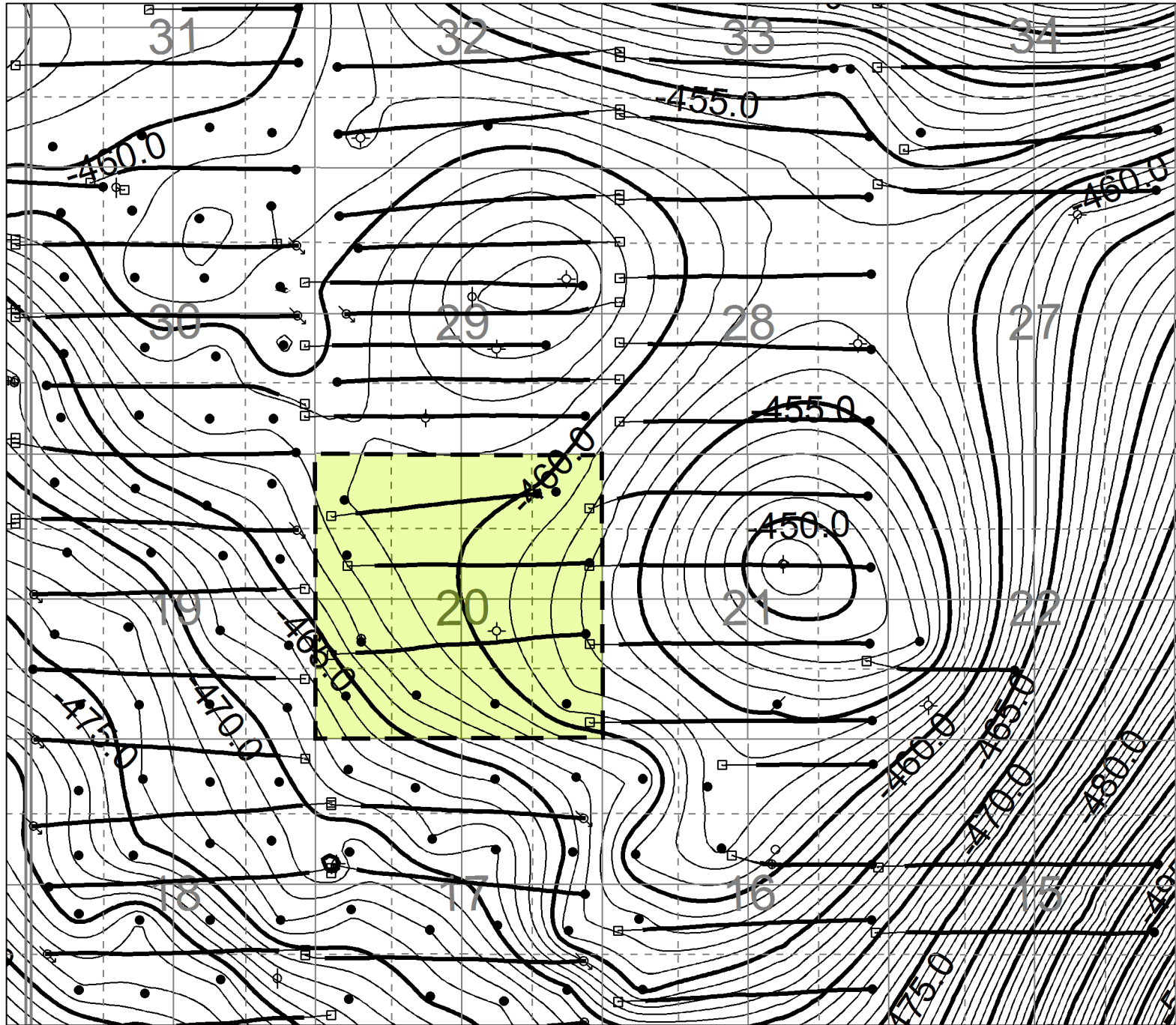

T7

T7

Tundra Oil & Gas Partnership	
EWART UNIT No. 8	
Torquay Shale Structure CI=1m	
APPENDIX 13	
Prepared by: Tundra Oil & Gas Partnership	
Date: 2014/02/04	
Scale: 1:12500	Project: Torquay Shale

R29

R28W1

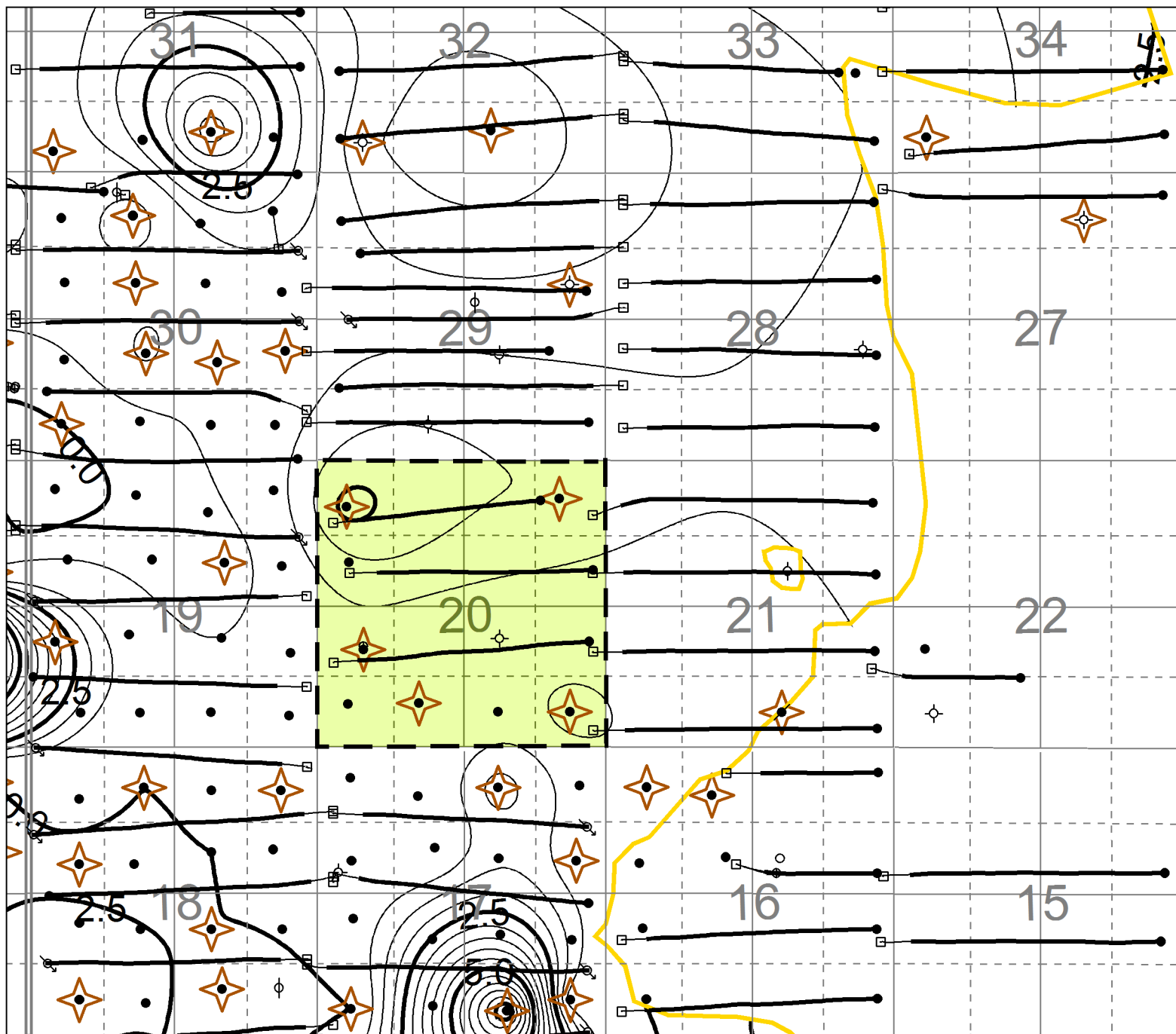

T7

T7

R29

R28W1

Tundra Oil & Gas Partnership	
EWART UNIT No. 8	
Middle Bakken k-h@0.5mD CO CI=0.5	
APPENDIX 14	
Licensed to: Tundra Oil & Gas Partnership	
By: [unclear]	Date: 2014/02/26
Scale: 1:12500	Project: [unclear]

R29

R28W1

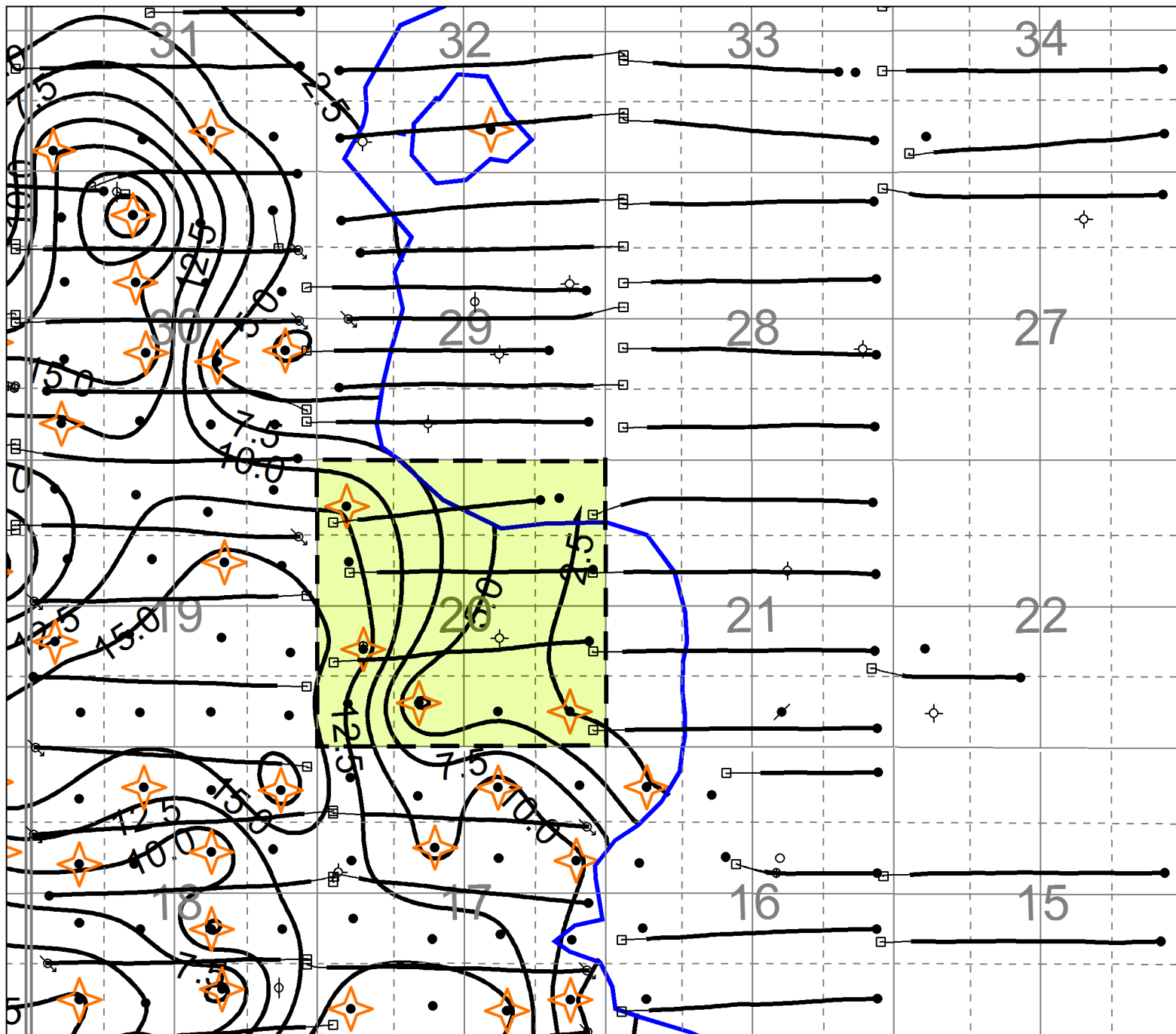

T7

T7

R29

R28W1

Tundra Oil & Gas Partnership	
EWART UNIT No. 8	
Lyleton Upper A k-h@1.0mD CO CI=2.5	
APPENDIX 15	
By: [Signature]	Date: 20/10/2016
Scale: 1:10000	Project: Sec 15, Dns

R29

R28W1

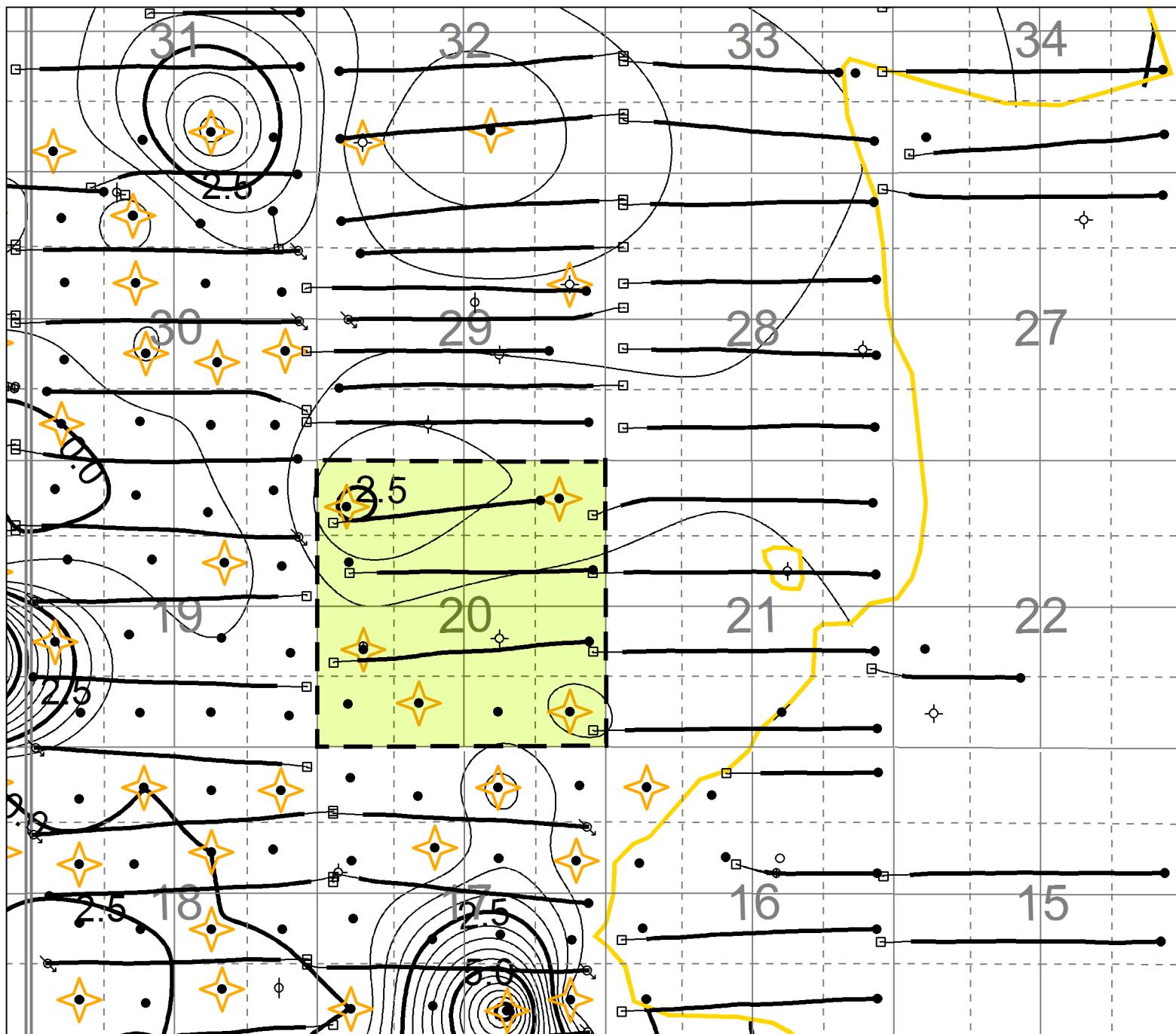

T7

T7

R29

R28W1

Tundra Oil & Gas Partnership
 EWART UNIT No. 8
 Lyleton Lower A k-h@1.0mD CO CI=0.5
 APPENDIX 16
 Licensed to: Tundra Oil & Gas Partnership
 By: Tundra
 Scale: 1:5000
 Project: 5000000000
 Date: 2014/02/25
 Project: 5000000000

R29

R28W1

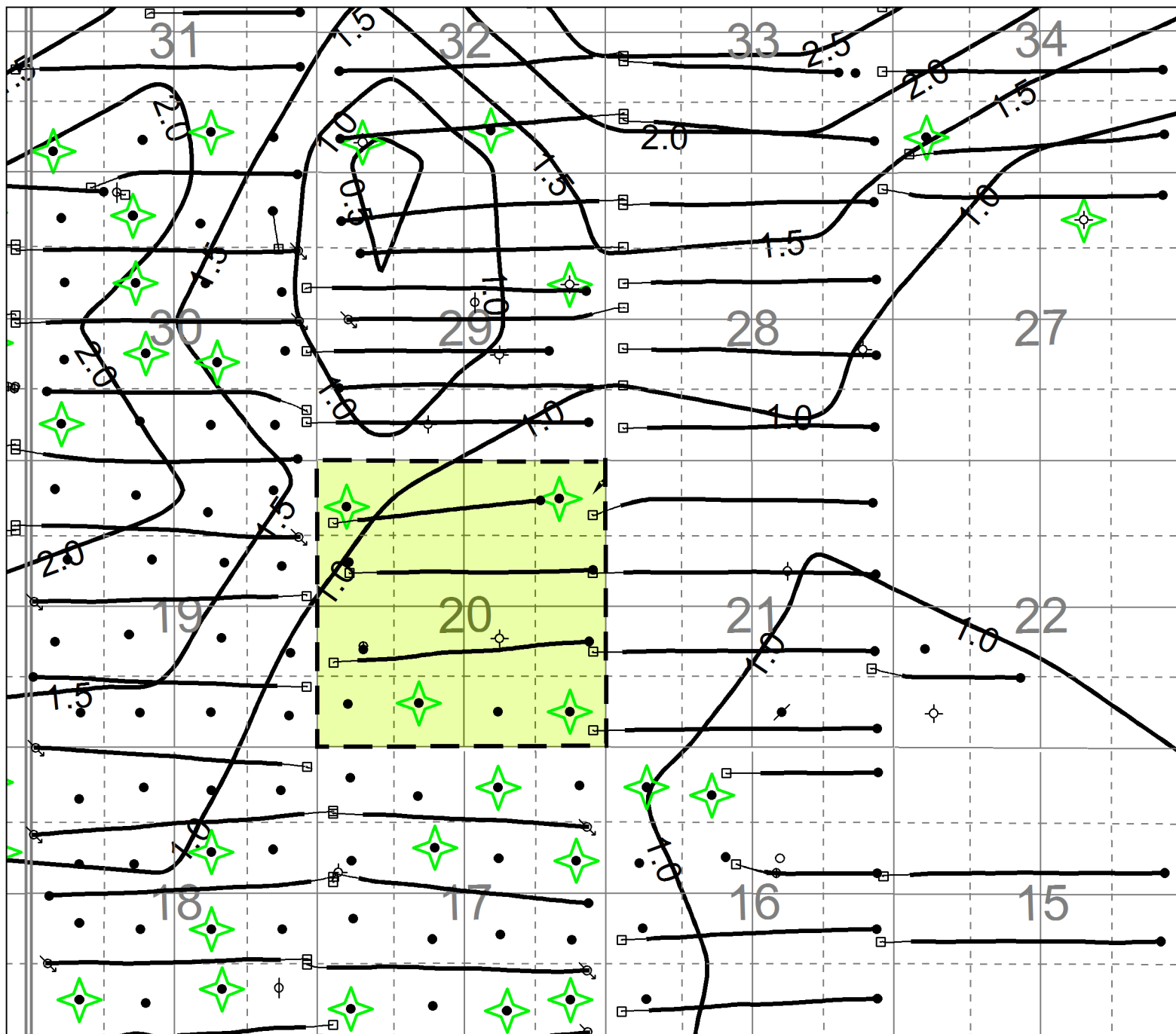

T7

T7

R29

R28W1

Tundra Oil & Gas Partnership
EWART UNIT No. 8
Lyleton B k-h@0.5mD CO CI=0.5
APPENDIX 17
Accessed by: Tundra Oil & Gas Partnership
Date: 2014/05/26
Scale: 1:50000
Product: Section Data

R29

R28W1

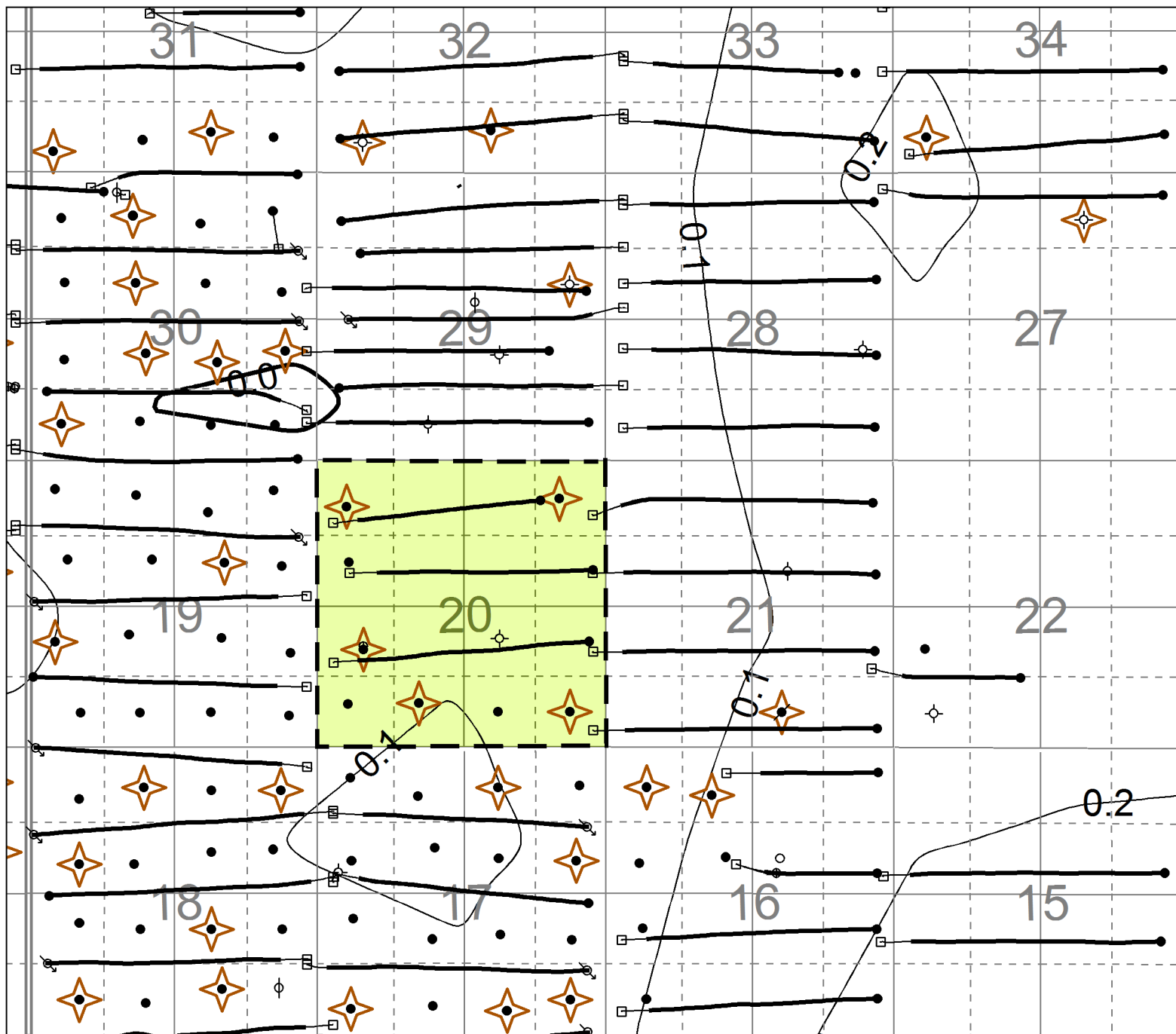

T7

T7

R29

R28W1

Tundra Oil & Gas Partnership	
EWART UNIT No. 8	
Middle Bakken phi-h@0.5mD CO CI=0.1	
APPENDIX 18	
<small>License No. Tundra Oil & Gas Partnership</small>	<small>Page: 20/10/2021</small>
<small>By: H. H. H. H.</small>	<small>Scale: 1:10000</small>
<small>gPSCOUT</small>	<small>Project: SPSM-001</small>

R29

R28W1

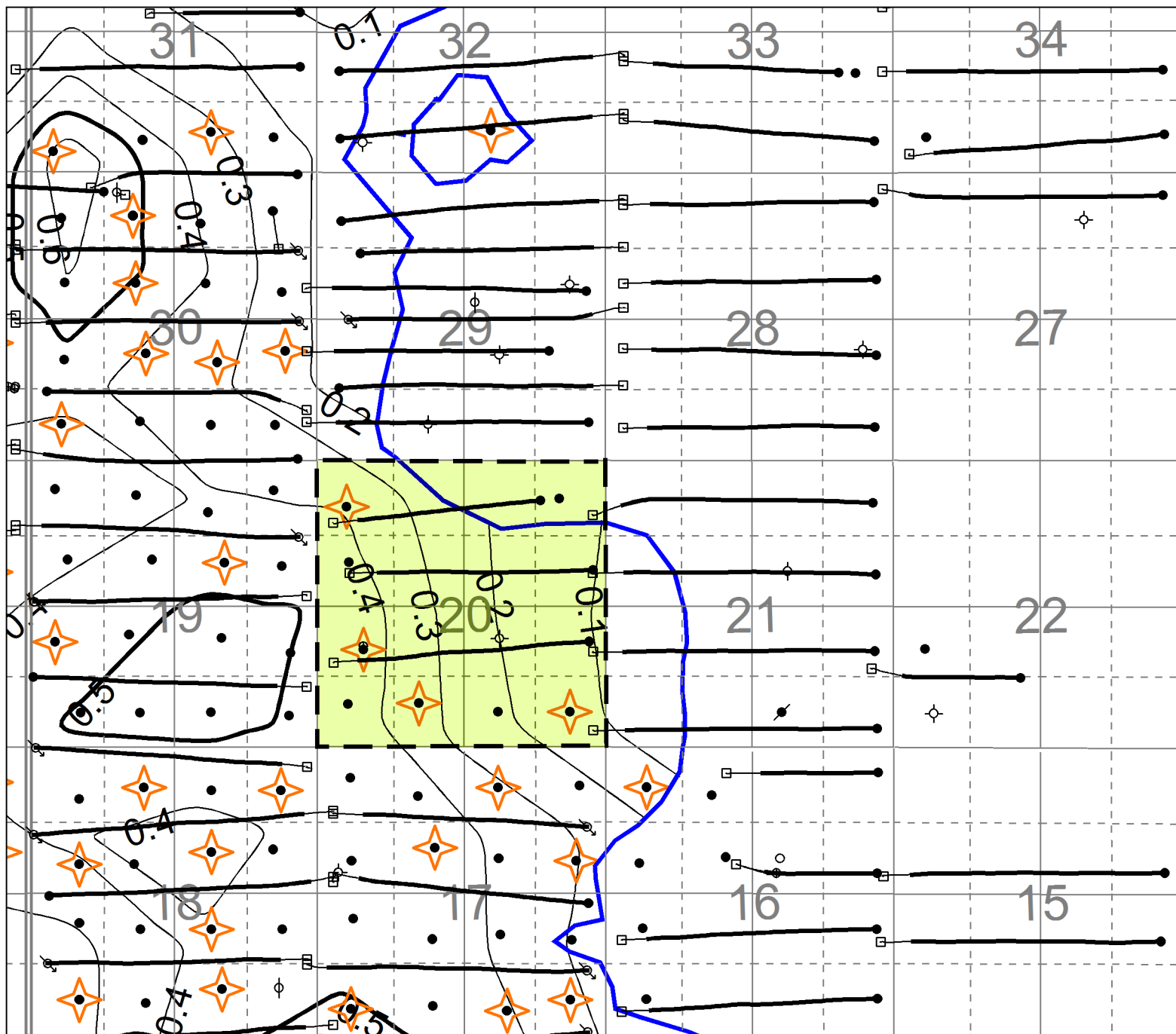

T7

T7

R29

R28W1

Tundra Oil & Gas Partnership	
EWART UNIT No. 8	
Lyleton Upper A phi-h@01.0mD CO CI=0.1	
APPENDIX 19	
<small> Licensed to: Tundra Oil & Gas Partnership Date: 2017-02-09 By: [Signature] Scale: 1:10000 Project: 200001-001 </small>	<small> Date: 2017-02-09 Project: 200001-001 </small>

R29

R28W1

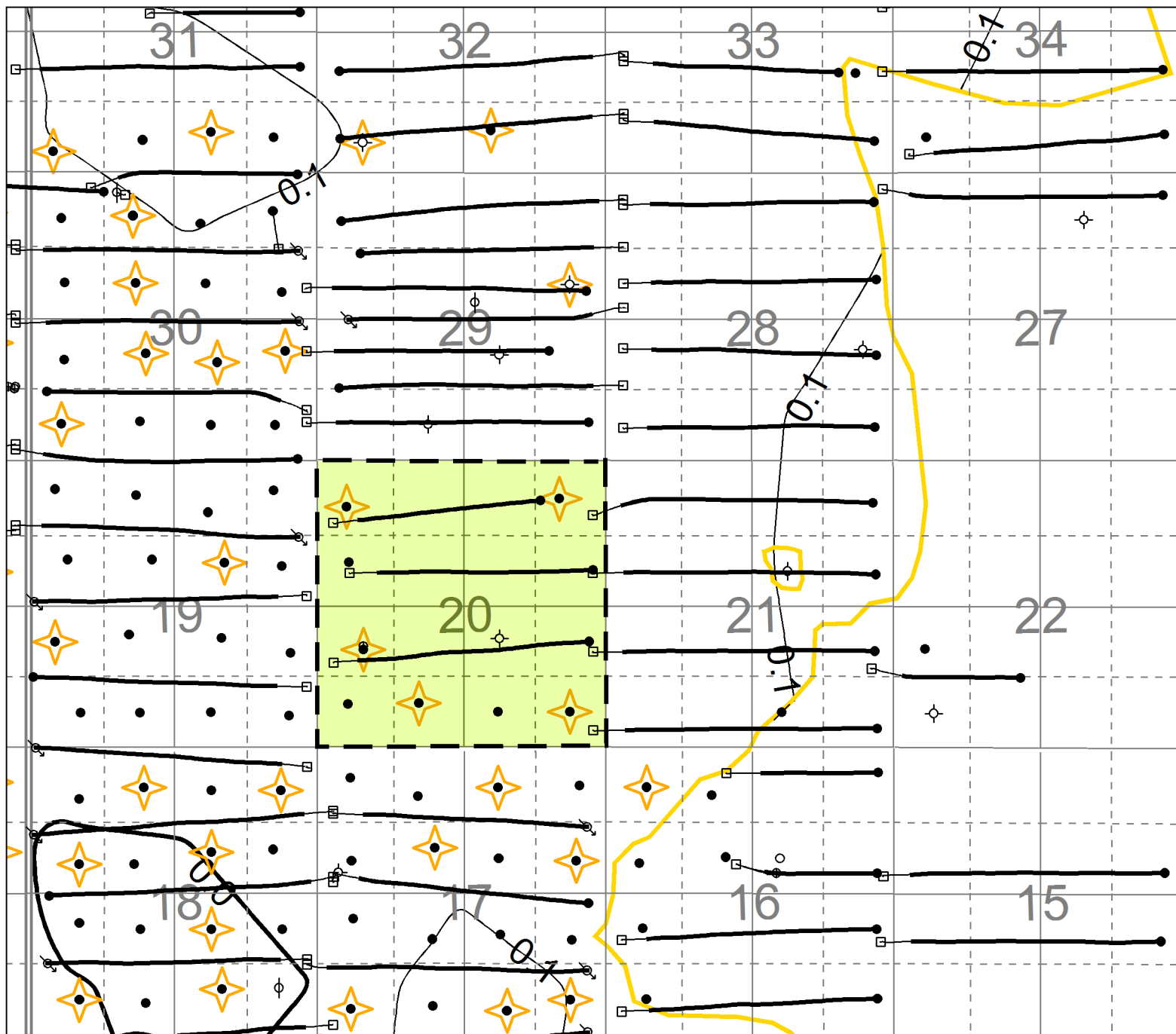

R29

R28W1

Tundra Oil & Gas Partnership	
EWART UNIT No. 8	
Lyleton Lower A phi-h@01.0mD CO CI=0.1	
APPENDIX 20	
By: [Signature]	Date: 2017-02-09
Scale: 1:10000	Project: 200001-001

R29

R28W1

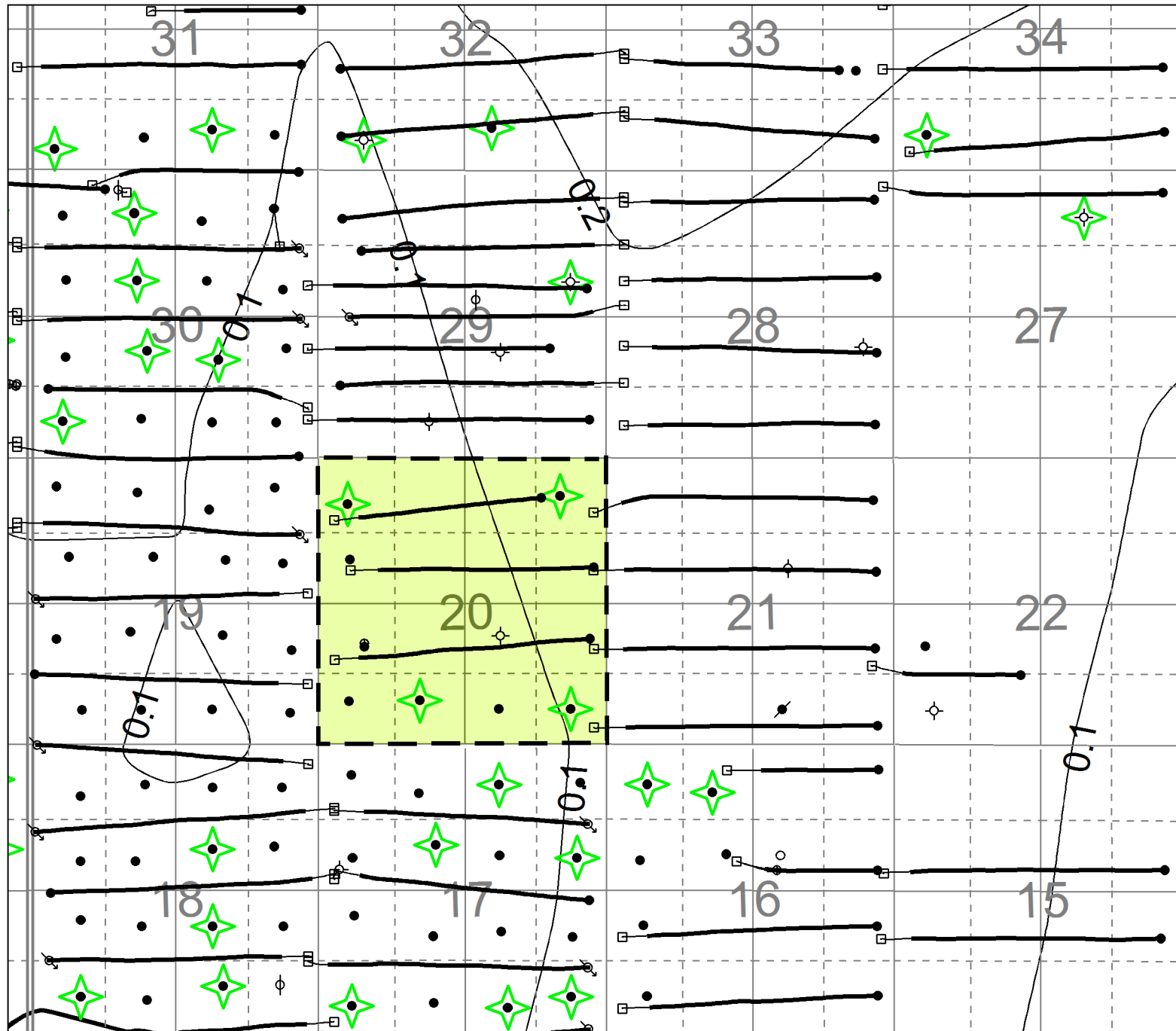

T7

T7

R29

R28W1

Tundra Oil & Gas Partnership	
EWART UNIT No. 8	
Lyleton B phi-h@0.5mD CO CI=0.1	
APPENDIX 21	
Prepared by: Tundra Oil & Gas Partnership	Date: 2014/02/20
By: [Signature]	Project: [Signature]
Scale: 1:50000	Project: [Signature]



R29

R28W1

T8

T8

T7

T7

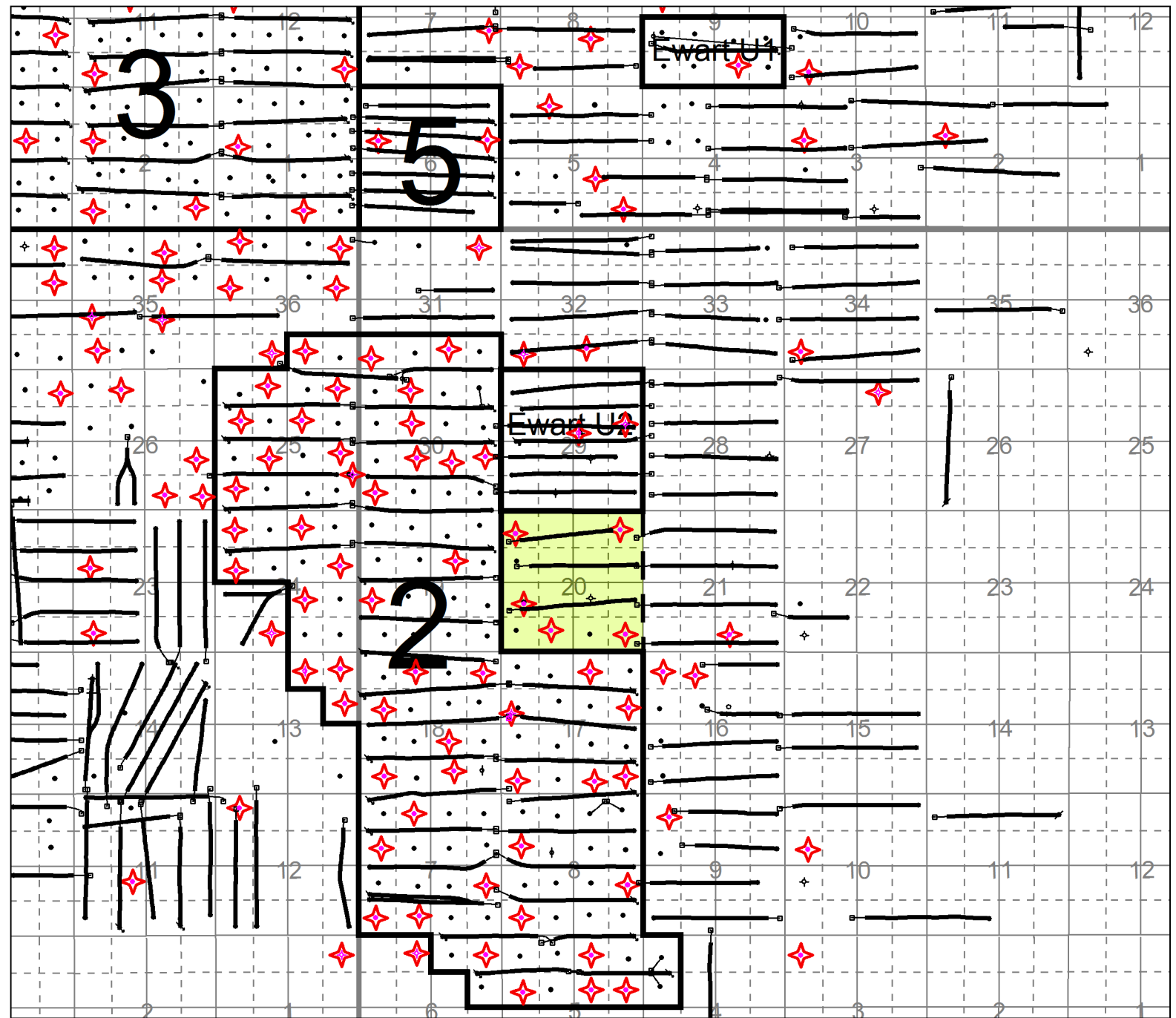

R29

R28W1