

**PROPOSED SINCLAIR UNIT NO. 22**

**Application for Enhanced Oil Recovery Waterflood Project**

**Middle Bakken/Three Forks Formations**

**Bakken – Torquay Pool (01 62A)**

**Daly Sinclair Field, Manitoba**

July 19, 2019  
Tundra Oil and Gas Partnership

## **INTRODUCTION**

The Sinclair portion of the Daly Sinclair Oil Field is located in Ranges 28 and 29 W1 in Townships 7 and 8 (Figure 1). Since discovery in 2004, the main oilfield area was developed with vertical and horizontal wells at 40 acre spacing on Primary Production. Since early 2009, a significant portion of the main oilfield has been unitized and placed on Secondary Waterflood (WF) Enhanced Oil Recovery (EOR) Production, mainly from the Lyleton A & B members of the Three Forks Formation. Tundra Oil and Gas (Tundra) currently operates and continues to develop Sinclair Units 1-3, 5-8, 10-14 and 18-21.

In the southern part of the Sinclair field, potential exists for incremental production and reserves from a Waterflood EOR project in the Three Forks and Middle Bakken oil reservoirs. The following represents an application by Tundra to establish Sinclair Unit No. 22 (LSDs 1-2, 7-10, 15-16 of Section 20-7-29W1, LSDs 3-6, 11-14 of Section 21-7-29W1, Section 29-7-29W1 and LSDs 1-8 of Section 32-7-29W1) and implement a Secondary Waterflood EOR scheme within the Three Forks and Middle Bakken formations as outlined on Figure 2.

The proposed project area falls within the existing designated 01-62A Bakken-Torquay Pool of the Daly Sinclair Oilfield (Figure 3).

## **SUMMARY**

1. The proposed Sinclair Unit No. 22 will include 9 vertical and 8 horizontal wells within 40 Legal Sub Divisions (LSD) of the Middle Bakken/Three Forks producing reservoir. The project is located west of Sinclair Unit No. 8 and Sinclair Unit No. 18 (Figure 2).
2. Total Net Original Oil in Place (OOIP) in Sinclair Unit No. 22 has been calculated to be **3,313** e<sup>3</sup>m<sup>3</sup> (20,835 Mbbbl) for an average of **82.8** net e<sup>3</sup>m<sup>3</sup> (520.9 Mbbbl) OOIP per 40 acre LSD based on a 0.5 md cutoff.
3. Cumulative production to the end of April 2019 from the 17 wells within the proposed Sinclair Unit No. 22 project area was **60.3** e<sup>3</sup>m<sup>3</sup> (379.2 Mbbbl) of oil, and **196.9** e<sup>3</sup>m<sup>3</sup> (1238.4 Mbbbl) of water, representing a **1.8%** Recovery Factor (RF) of the Net OOIP.
4. Figure 4 shows the production from Sinclair Unit No. 22 peaked in April 2009 at 42.2 m<sup>3</sup> of oil per day (OPD). As of April 2019, production was 7.32 m<sup>3</sup> OPD, 26.8 m<sup>3</sup> of water per day (WPD) and a 78.5% watercut. Decline analysis of the well primary production data forecasts total oil to continue to decline at an annual rate of approximately 21.3%.
5. Estimated Ultimate Recovery (EUR) of Primary Proved Producing oil reserves in the proposed Sinclair Unit No. 22 project area has been calculated to be **77.2** e<sup>3</sup>m<sup>3</sup> (485.7.3 Mbbbl), with **16.9** e<sup>3</sup>m<sup>3</sup> (106.3 Mbbbl) remaining as of the end of April 2019.
6. Ultimate oil recovery of the proposed Sinclair Unit No. 22 OOIP, under the current Primary Production method, is forecasted to be **2.3%**.
7. Estimated Ultimate Recovery (EUR) of proved oil reserves under Secondary WF EOR for the proposed Sinclair Unit No. 22 has been calculated to be **159.2** e<sup>3</sup>m<sup>3</sup> (1001.6 Mbbbl), with **98.8** e<sup>3</sup>m<sup>3</sup> (622.0 Mbbbl) remaining. An incremental **81.9** e<sup>3</sup>m<sup>3</sup> (515.1 Mbbbl) of proved oil reserves, or **2.5%**, are forecasted to be recovered under the proposed Unitization and Secondary EOR production vs the existing Primary Production method.
8. Total RF under Secondary WF in the proposed Sinclair Unit No. 22 is estimated to be **4.8%**.
9. Based on the waterflood response in the adjacent main portion of the Sinclair field, the Three Forks and Middle Bakken Formations in the proposed project area are believed to be suitable reservoirs for WF EOR operations.
10. Existing horizontal wells, with multi-stage hydraulic fractures, will be converted to injection wells (Figure 5) within the proposed Sinclair Unit 22, to complete waterflood patterns with effective 20 acre spacing similar to Sinclair Unit No. 5.

## **DISCUSSION**

The proposed Sinclair Unit No. 22 project area is located within Township 7, Range 29 W1 of the Daly Sinclair Oil Field. The proposed Sinclair Unit No. 22 currently consists of 9 vertical and 8 horizontal wells, within an area covering 40 LSDs in LSDs 1-2, 7-10, 15-16 of Section 20-7-29W1, LSDs 3-6, 11-14 of Section 21-7-29W1, Section 29-7-29W1 and LSDs 1-8 of Section 32-7-29W1 (Figure 2). A project area well list complete with recent production statistics is attached as Table 3.

Tundra believes that the waterflood response in the adjacent main portion of the Sinclair field demonstrates potential for incremental production and reserves from a WF EOR project in the subject Middle Bakken and/or Three Forks oil reservoirs.

## **Geology**

### **Stratigraphy:**

The stratigraphy of the reservoir section for the proposed unit is shown on the structural cross-section attached as Appendix 2. The section runs S to N through the proposed Unit area. The producing sequence in descending order consists of the Upper Bakken Shale, Middle Bakken Siltstone, Lyleton A Siltstone (broken into Upper and Lower members), the Red Shale Marker, Lyleton B Siltstone and the Torquay Silty Shale. The reservoir units are represented by the Middle Bakken, Upper Lyleton A and Lower Lyleton A. The Upper Bakken Shale is a black, organic rich, platy shale which forms the top seal for the underlying Middle Bakken and Lyleton reservoirs. The reservoir units in the proposed unit are analogous to the Bakken / Lyleton producing reservoirs that have been approved adjacent to the proposed unit (Sinclair Unit 8, Sinclair Unit 18, Sinclair Unit 9 and Sinclair Unit 16) as noted on the Offsetting Units Map at Appendix 1.

### **Sedimentology:**

The Middle Bakken reservoir consists of fine to coarse grained grey siltstone to fine sandstone which may be subdivided on the basis of lithologic characteristics into upper and lower units. The upper portion is very often heavily bioturbated and is generally non-reservoir. These bioturbated beds often contain an impoverished fauna consisting of well-worn brachiopod, coral and occasional crinoid fragments suggesting deposition in a marginal marine environment. The lower part of the Middle Bakken is generally finely laminated with alternating light and dark laminations with occasional bioturbation. Reservoir quality is highly variable within the Unit area. Within the proposed unit, the Middle Bakken thickness ranges from less than 1m to 2.5m in the South West (Appendix 4).

The Lyleton A reservoir within the proposed unit area consists of buff to tan medium to coarse siltstone (occasionally fine sandstone) made up of quartz, feldspar and detrital dolomite with minor mica and clay mostly in the form of clay clasts or chips. Clays do not generally occur as pore filling material, but rather as discrete grains within the siltstone. The Upper part is generally well bedded and shows evidence of parallel lamination with occasional wind ripples. The coarser siltstones are interbedded with finer grained grey-green siltstone similar in composition to the reservoir siltstone, but generally with lower

permeability (i.e. < 0.1mD). These finer grained siltstones show evidence of haloturbation producing smeared siltstone clasts floating in a fine-grained grey-green siltstone matrix. The lower part of the Lyleton A generally shows a greater proportion of the grey-green fine-grained siltstone than the Upper and is generally a poorer reservoir. It also tends to exhibit greater amounts of haloturbation and pseudo-breccia of siltstone clasts in a finer grained siltstone matrix. Because of the fine-grained matrix in this pseudo-breccia the connectivity between the clasts is much lower than the bedded siltstone and the Lower part of the Lyleton A is generally a poorer reservoir than the Upper part of the Lyleton A. Within the proposed unit area the Upper Lyleton A ranges from over 6m in the North West to 2.5m in the South (Appendix 5). The Lower Lyleton A is fairly consistent in the proposed unit area ranging around 3.5m (Appendix 6).

The Red Shale Marker lies between the overlying Middle Bakken / Lyleton A and the underlying Lyleton B reservoir. It consists of brick red dolomitic siltstone which is highly water soluble and has low permeability.

The Lyleton B consists of buff to tan fine grained siltstone (occasionally very fine siltstone) made up of quartz, feldspar and detrital dolomite with minor mica and clay mostly in the form of clay clasts or chips. The Lyleton B is generally well bedded and shows evidence of parallel lamination with occasional wind ripples. The coarser siltstones are interbedded with dark grey-green or red very fine-grained siltstone which is generally non-reservoir.

The Torquay (Three Forks) forms the base of the reservoir sequence and is a brick red or mint green dolomitic very fine siltstone similar to the Red Shale Marker and it forms a good basal seal to the Lyleton B reservoir.

#### **Structure:**

The structure within the proposed unit area is relatively consistent with the regional trend, dipping toward the South West (Appendix 3).

#### **Reservoir Continuity:**

Lateral continuity of the reservoir units is an essential requirement of a successful waterflood. As demonstrated by the cross section and the isopach maps, all reservoir formations, the Middle Bakken, Upper Lyleton A and Lower Lyleton A are continuous throughout the proposed unit area.

Vertical continuity between the Middle Bakken and underlying Lyleton A reservoir exists throughout the proposed unit as they are in direct contact.

#### **Gross OOIP Estimates**

Total volumetric OOIP for the Middle Bakken Upper Lyleton A and Lower Lyleton A within the proposed unit has been calculated to be **3,313** e<sup>3</sup>m<sup>3</sup> (**20,835** Mbbl) using Tundra internally created maps. Maps used were generated from core data from wells available in the greater Sinclair area (Appendix 7).

An average net to gross ratio was calculated for each reservoir formation using pressure decay profile permeameter data (PDPK) with a cut off of 0.5mD on surrounding cored wells. To determine net pay these ratios are then applied to each formation thickness from isopach maps based on logs. Porosity is calculated in the same way, using an average from surrounding core data after a 0.5mD cutoff.

Tabulated parameters for each LSD from the calculations can be found in Table 4.

OOIP values were calculated using the following volumetric equation:

$$OOIP = \frac{Area * Net Pay * Porosity * (1 - Water Saturation)}{Initial Formation Volume Factor of Oil}$$

or

$$OOIP(m3) = \frac{A * h * \phi * (1 - Sw)}{Bo} * \frac{10,000m2}{ha}$$

or

$$OOIP(Mbbl) = \frac{A * h * \phi * (1 - Sw)}{Bo} * 3.28084 \frac{ft}{m} * 7,758.367 \frac{bbl}{acre * ft} * \frac{1Mbbl}{1,000bbl}$$

where

OOIP	= Original Oil in Place by LSD (Mbbbl, or m3)
A	= Area (40acres, or 16.187 hectares, per LSD)
h * $\phi$	= Net Pay * Porosity, or Phi * h (ft, or m)
Bo	= Formation Volume Factor of Oil (stb/rb, or sm3/rm3)
Sw	= Water Saturation (decimal)

The initial oil formation volume factor was adopted from PVT information taken from the 100/02-17-009-29W1 and 100/13-19-009-28W1 Bakken wells and is thought to be representative of the fluid characteristics in the reservoir.

### **Historical Production**

A historical group production history plot for the proposed Sinclair Unit No. 22 is shown as **Figure 4**. Oil production commenced from the proposed Unit area in February 2007 and peaked during April 2009 at 42.2 m<sup>3</sup> (OPD). As of April 2019, production was 7.32 m<sup>3</sup> OPD, 26.8 m<sup>3</sup> of water per day (WPD) and a 78.5% watercut.

From peak production in April 2009, oil production is declining at an annual rate of approximately 21.3% under the current Primary Production method.

The remainder of the field's production and decline rates indicate the need for pressure restoration and maintenance. Waterflooding is deemed to be the most efficient means of secondary recovery to introduce energy back into the system and provide areal sweep between wells.

## **UNITIZATION**

Unitization and implementation of a Waterflood EOR project is forecasted to increase overall recovery of OOIP from the proposed project area.

### **Unit Name**

Tundra proposes that the official name of the new Unit shall be Sinclair Unit No. 22.

### **Unit Operator**

Tundra Oil and Gas (Tundra) will be the Operator of record for Sinclair Unit No. 22.

### **Unitized Zone**

The Unitized zone(s) to be waterflooded in Sinclair Unit No. 22 will be the Middle Bakken and Three Forks formations.

### **Unit Wells**

The 9 vertical and 8 horizontal wells to be included in the proposed Sinclair Unit No. 22 are outlined in [Table 3](#).

### **Unit Lands**

The Sinclair Unit No. 22 will consist of 40 LSDs as follows:

LSDs 1-2, 7-10, 15-16 of Section 20 of Township 7, Range 29, W1M  
LSDs 3-6, 11-14 of Section 21 of Township 7, Range 29, W1M  
Section 29 of Township 7, Range 29, W1M  
LSDs 1-8 of Section 32 of Township 7, Range 29, W1M

The lands included in the 40 acre tracts are outlined in [Table 1](#).

### **Tract Factors**

The proposed Sinclair Unit No. 22 will consist of 40 Tracts based on the 40 acre LSDs containing the existing 9 vertical and 8 horizontal wells.

The Tract Factor contribution for each of the LSD's within the proposed Sinclair Unit No. 22 was calculated as follows:

- Gross OOIP by LSD, minus cumulative production to date for the LSD as distributed by the LSD specific Production Allocation (PA) % in the applicable producing horizontal or vertical well (to yield Remaining Gross OOIP)
- Tract Factor by LSD = the product of Remaining Gross OOIP by LSD as a % of total proposed Unit Remaining Gross OOIP

Tract Factor calculations for all individual LSDs based on the above methodology are outlined within **Table 2**.

### **Working Interest Owners**

**Table 1** outlines the working interest (WI) for each recommended Tract within the proposed Sinclair Unit No. 22. Tundra Oil and Gas Partnership holds a 100% WI ownership in all the proposed Tracts.

Tundra Oil and Gas Partnership will have a 100% WI in the proposed Sinclair Unit No. 22.



## WATERFLOOD EOR DEVELOPMENT

### Technical Studies

The waterflood performance predictions for the proposed Sinclair Unit No. 22 Bakken project are based on internal engineering assessments. Project area specific reservoir and geological parameters were utilized and then compared to Sinclair Unit No. 5 parameters, yielding the WF EOR response observed there to date.

### Reserves Recovery Profiles and Production Forecasts

The primary waterflood performance predictions for the proposed Sinclair Unit No. 22 are based on oil production decline curve analysis, and the secondary predictions are based on internal engineering analysis performed by the Tundra reservoir engineering group using Sinclair Unit No. 5 as an analogy because it is developed with a similar waterflood pattern design of a horizontal injector with offsetting horizontal producers at 20 acre spacing.

#### Primary Production Forecast

Cumulative production in the Sinclair Unit No. 22 project area, to the end of April 2019 from 17 wells, is **60.3** e<sup>3</sup>m<sup>3</sup> of oil and **196.9** e<sup>3</sup>m<sup>3</sup> of water for a recovery factor of **1.8%** of the calculated Net OOIP.

Ultimate Primary Proved Producing oil reserves recovery for Sinclair Unit No. 22 has been estimated to be **77.2** e<sup>3</sup>m<sup>3</sup>, or an **2.3%** Recovery Factor (RF) of OOIP. Remaining Producing Primary Reserves has been estimated to be **16.9** e<sup>3</sup>m<sup>3</sup> to end of April 2019.

The expected production decline and forecasted cumulative oil recovery under continued Primary Production is shown in **Figures 7 and 8**.

#### Pre-Production Schedule/Timing for Conversion of Horizontal Wells to Water Injection

Tundra will plan an injection conversion schedule to allow for the most expeditious development of the waterflood within the proposed Sinclair Unit No. 22, while maximizing reservoir knowledge.

#### Criteria for Conversion to Water Injection Well

Nine (9) water injection wells are required for this proposed unit as shown in **Figure 5**.

Tundra will monitor the following parameters to assess the best timing for the horizontal well to be converted from primary production to water injection service.

- Measured reservoir pressures at start of and/or through primary production
- Fluid production rates and any changes in decline rate
- Any observed production interference effects with adjacent vertical and horizontal wells
- Pattern mass balance and/or oil recovery factor estimates
- Reservoir pressure relative to bubble point pressure

The above allows for the proposed Sinclair Unit No. 22 project to be developed equitably and efficiently. It also provides the Unit Operator flexibility to manage the reservoir conditions and response to help ensure maximum ultimate recovery of OOIP.

### Secondary EOR Production Forecast

The proposed project oil production profile under Secondary Waterflood has been developed based on the response observed to date in the Sinclair Unit No. 5 Waterflood (Figure 6).

Secondary Waterflood plots of the expected oil production forecast over time and the expected oil production vs. cumulative oil are plotted in Figures 9 and 10, respectively. Total Secondary EUR for the proposed Sinclair Unit No. 22 is estimated to be **159.2** e<sup>3</sup>m<sup>3</sup> with **98.8** e<sup>3</sup>m<sup>3</sup> remaining, representing a total secondary recovery factor of **4.8%** for the proposed Unit area. An incremental **81.9** e<sup>3</sup>m<sup>3</sup> of oil, or a **2.5%** recovery factor, are forecasted to be recovered under the proposed Unitization and Secondary EOR production scheme vs. the existing Primary Production method.

### Estimated Fracture Pressure

Completion data from the existing producing wells within the project area indicate an actual fracture pressure gradient range of 18.0 to 22.0 kPa/m true vertical depth (TVD).

## WATERFLOOD OPERATING STRATEGY

### Water Source

The injection water for the proposed Sinclair Unit No. 22 will be supplied from the existing Sinclair 3-4-8-29W1 Battery source and injection water system. All existing injection water is obtained from the Mannville formation in the 103/12-04-8-29W1 (103/12-04) licensed water source well. Mannville water from the 103/12-04 source well is pumped to the main Sinclair Units Water Plant at 3-4-8-29W1, filtered, and pumped up to injection system pressure. A diagram of the Sinclair water injection system and new pipeline connection to the proposed Sinclair Unit No. 22 project area injection wells is shown as Figure 11.

Produced water is not currently used for any water injection in the Tundra operated Sinclair Units due to technical and economic factors that limit Tundra's ability to filter down to the necessary particle size for this tight formation. Therefore, there are no current plans to use produced water as a source supply for Sinclair Unit No. 22.

Since all producing Middle Bakken/Three Forks wells in the Daly Sinclair areas, whether vertical or horizontal, have been hydraulically fractured, produced waters from these wells are inherently a mixture of Three Forks and Bakken native sources. This mixture of produced waters has been extensively tested for compatibility with 103/12-04 source Mannville water, by a highly qualified third party, prior to implementation by Tundra. All potential mixture ratios between the two waters, under a range of temperatures, have been simulated and evaluated for scaling and precipitate producing tendencies. Testing of multiple scale inhibitors has also been conducted and minimum inhibition

concentration requirements for the source water volume determined. At present, continuous scale inhibitor application is maintained into the source water stream out of the Sinclair injection water facility. Review and monitoring of the source water scale inhibition system is also part of an existing routine maintenance program.

### **Injection Wells**

The water injection wells for the proposed Sinclair Unit No. 22 will be current producing wells configured downhole for injection as shown in **Figure 12**. The horizontal injection well will have been stimulated by multiple hydraulic fracture treatments to obtain suitable injection. Tundra has extensive experience with horizontal fracturing in the area, and all jobs are rigorously programmed and monitored during execution. This helps ensure optimum placement of each fracture stage to prevent, or minimize, the potential for out-of-zone fracture growth and thereby limit the potential for future out-of-zone injection.

Wellhead injection pressures will be maintained below the least value of either:

- the area specific known and calculated fracture gradient, or
- the licensed surface injection Maximum Allowable Pressure (MOP)

Tundra has a thorough understanding of area fracture gradients. A management program will be utilized to set and routinely review injection target rates and pressures vs. surface MOP and the known area formation fracture pressures.

All new water injection wells are surface equipped with injection volume metering and rate/pressure control. An operating procedure for monitoring water injection volumes and meter balancing will also be utilized to monitor the entire system measurement and integrity on a daily basis.

The proposed Sinclair Unit No. 22 horizontal water injection well rate is forecasted to average **10 - 30 m<sup>3</sup>** WPD, based on expected reservoir permeability and pressure.

### **Reservoir Pressure**

No recent or representative initial pressure surveys are currently available for the producing wells within the proposed Sinclair Unit No. 22 project area in the Bakken formation. The long shut-in and build-up times required to obtain any possible representative surveys from the producing wells are economically prohibitive. Tundra will make all attempts to capture a reservoir pressure survey in the proposed horizontal injection wells during the completion of the wells and prior to injection or production.

### **Reservoir Pressure Management during Waterflood**

Tundra expects it will take 2-4 years to re-pressurize the reservoir due to cumulative primary production voidage and pressure depletion. Initial monthly Voidage Replacement Ratio (VRR) is expected to be approximately 1.25 to 2.00 within the patterns during the fill up period. As the cumulative VRR approaches 1, target reservoir operating pressure for waterflood operations will be 75-90% of original reservoir pressure.

## **Waterflood Surveillance and Optimization**

Sinclair Unit No. 22 EOR response and waterflood surveillance will consist of the following:

- Regular production well rate and WCT testing
- Daily water injection rate and pressure monitoring vs target
- Water injection rate/pressure/time vs. cumulative injection plot
- Reservoir pressure surveys as required to establish pressure trends
- Pattern VRR
- Potential use of chemical tracers to track water injector/producer responses
- Use of some or all of: Water Oil Ratio (WOR) trends, Log WOR vs Cum Oil, Hydrocarbon Pore Volumes Injected, Conformance Plots

The above surveillance methods will provide an ever-increasing understanding of reservoir performance, and provide data to continually control and optimize the Sinclair Unit No. 22 waterflood operation. Controlling the waterflood operation will significantly reduce or eliminate the potential for out-of-zone injection, undesired channeling or water breakthrough, or out-of-Unit migration. The monitoring and surveillance will also provide early indicators of any such issues so that waterflood operations may be altered to maximize ultimate secondary reserves recovery from the proposed Sinclair Unit No. 22.

## **On Going Reservoir Pressure Surveys**

Any pressures taken during the operation of the proposed unit will be reported within the Annual Progress Reports for Sinclair Unit No. 22 as per Section 73 of the Drilling and Production Regulation.

## **Economic Limits**

Under the current Primary recovery method, existing wells within the proposed Sinclair Unit No. 22 will be deemed uneconomic when the net oil rate and net oil price revenue stream becomes less than the current producing operating costs. With any positive oil production response under the proposed Secondary recovery method, the economic limit will be significantly pushed out into the future. The actual economic cut off point will then again be a function of net oil price, the magnitude and duration of production rate response to the waterflood, and then current operating costs. Waterflood projects generally become uneconomic to operate when Water Oil Ratios (WOR's) exceed 100.

## **WATER INJECTION FACILITIES**

The Sinclair Unit No. 22 waterflood operation will utilize the existing Tundra operated source well supply and water plant (WP) facilities located at 3-4-8-29W1 Battery. Injection wells will be connected to the existing high pressure water pipeline system supplying other Tundra-operated Waterflood Units.

A complete description of all planned system design and operational practices to prevent corrosion related failures is shown in **Figure 13**.

## **NOTIFICATION OF MINERAL AND SURFACE RIGHTS OWNERS**

Tundra is in the process of notifying all mineral rights and surface rights owners of this proposed EOR project and formation of Sinclair Unit No. 22. Copies of the notices and proof of service, to all surface and mineral rights owners will be forwarded to the Petroleum Branch when available to complete the Sinclair Unit No. 22 Application.

Sinclair Unit No. 22 Unitization, and execution of the formal Sinclair Unit No. 22 Agreement by affected Mineral Owners, is expected during Q3 2019. Copies of same will be forwarded to the Petroleum Branch, when available, to complete the Sinclair Unit No. 22 Application.

Should the Petroleum Branch have further questions or require more information, please contact Eric Fraser at 587.747.5363 or by email at [eric.fraser@tundraoilandgas.com](mailto:eric.fraser@tundraoilandgas.com).

## **TUNDRA OIL & GAS PARTNERSHIP**

Original Signed by Eric Fraser, July 19, 2019 in Calgary, AB

## **Proposed Sinclair Unit No. 22**

### **Application for Enhanced Oil Recovery Waterflood Project**

#### **LIST OF APPENDICES**

Appendix 1	Sinclair Unit No. 22 – Offsetting Units
Appendix 2	Sinclair Unit No. 22 - Structural Cross Section
Appendix 3	Sinclair Unit No. 22 – Middle Bakken Structure
Appendix 4	Sinclair Unit No. 22 – Middle Bakken Isopach
Appendix 5	Sinclair Unit No. 22 – Upper Lyleton A Isopach
Appendix 6	Sinclair Unit No. 22 – Lower Lyleton A Isopach
Appendix 7	Core PDPK Data

# APPENDIX 1

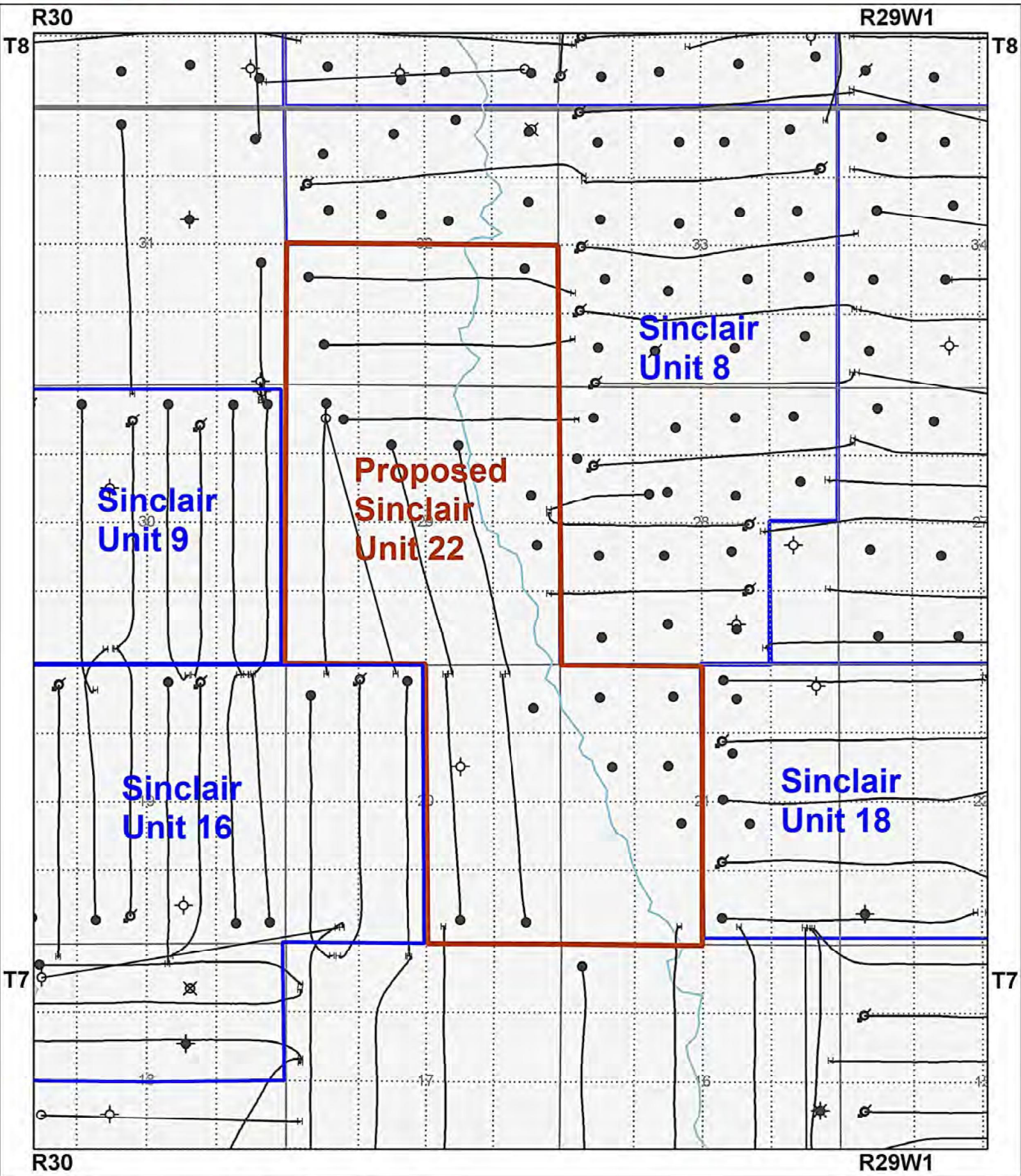

Center: 49.5956, -101.3762

Scale: 1:31,673

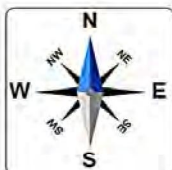
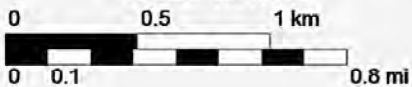

Proposed Sinclair Unit 22  
Offsetting Bakken Units

00/06-21-007-29W1/0  
 KB: 517.1 m RR: 2007-03-16  
 TD: 1056.0 m [TVD] FormTD: BIRDBER  
 Mode: Prod Fluid: Oil  
 TUNDRA SINCLAIR 6-21-7-29(WPM)  
 1843.6m to next well >

00/08-29-007-29W1/0  
 KB: 519.4 m RR: 2007-12-01  
 TD: 1037.0 m [TVD] FormTD: TORQUAY  
 Mode: Prod Fluid: Oil  
 TUNDRA SINCLAIR PROV. 8-29-7-29 (WPM)  
 < 1843.6m to previous well 1629.7m to next well >

00/08-32-007-29W1/0  
 KB: 522.4 m RR: 2008-06-02  
 TD: 1041.0 m [TVD] FormTD: TORQUAY  
 Mode: Prod Fluid: Oil  
 TUNDRA SINCLAIR PROV. 8-32-7-29 (WPM)  
 < 1629.7m to previous well



Proposed Sinclair Unit 22  
 Structural Cross Section  
 -South to North-  
 Through Proposed Unit Area



# APPENDIX 3

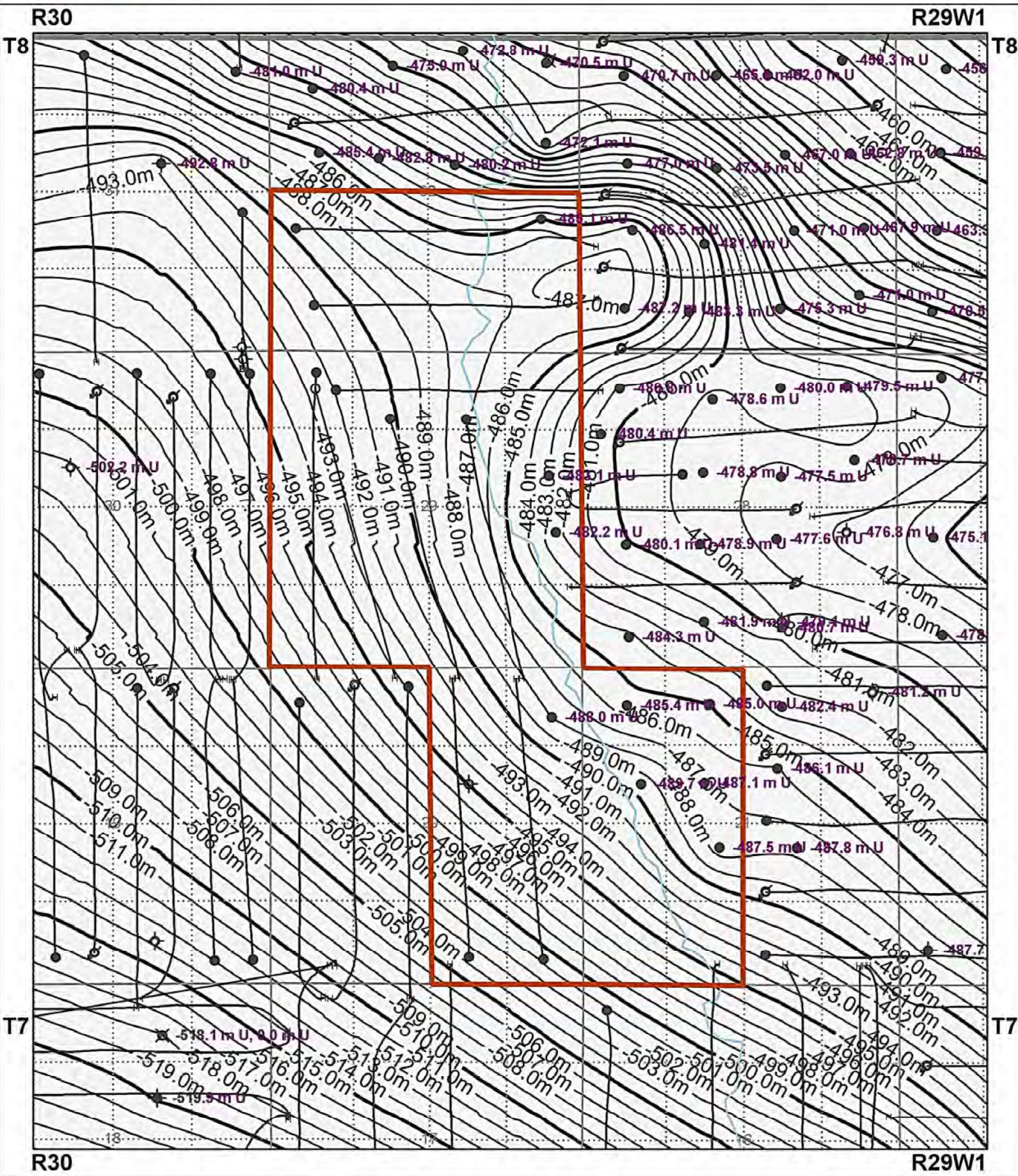

Center: 49.5956, -101.3762

Scale: 1:31,673

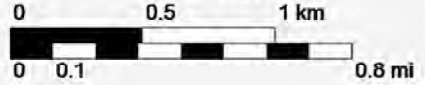

Proposed Sinclair Unit 22  
Middle Bakken Structure  
(mSS)

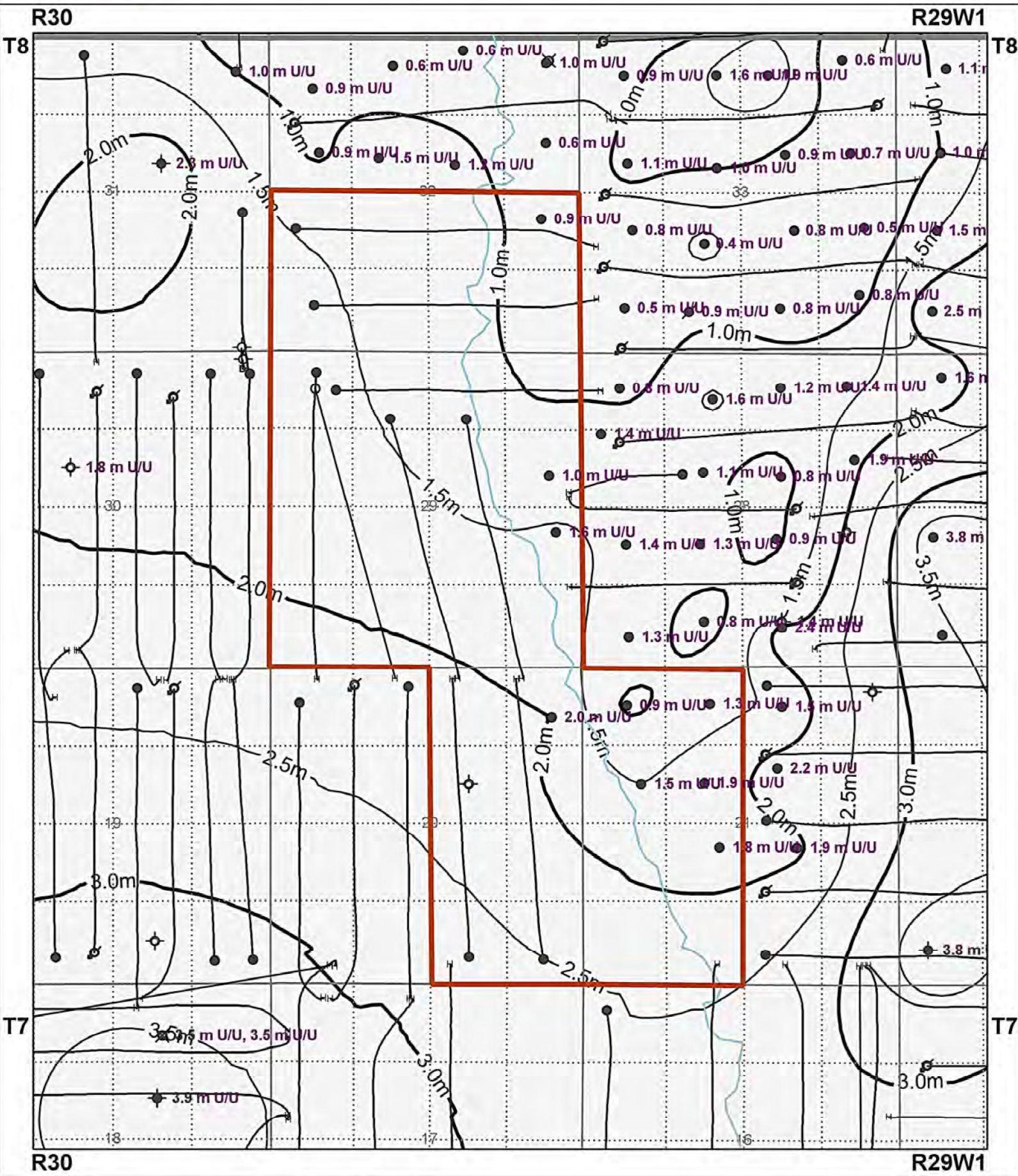

Center: 49.5956, -101.3762

Scale: 1:31,673

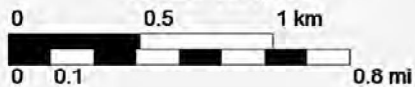

Proposed Sinclair Unit 22  
Middle Bakken Isopach  
(m)

# APPENDIX 5

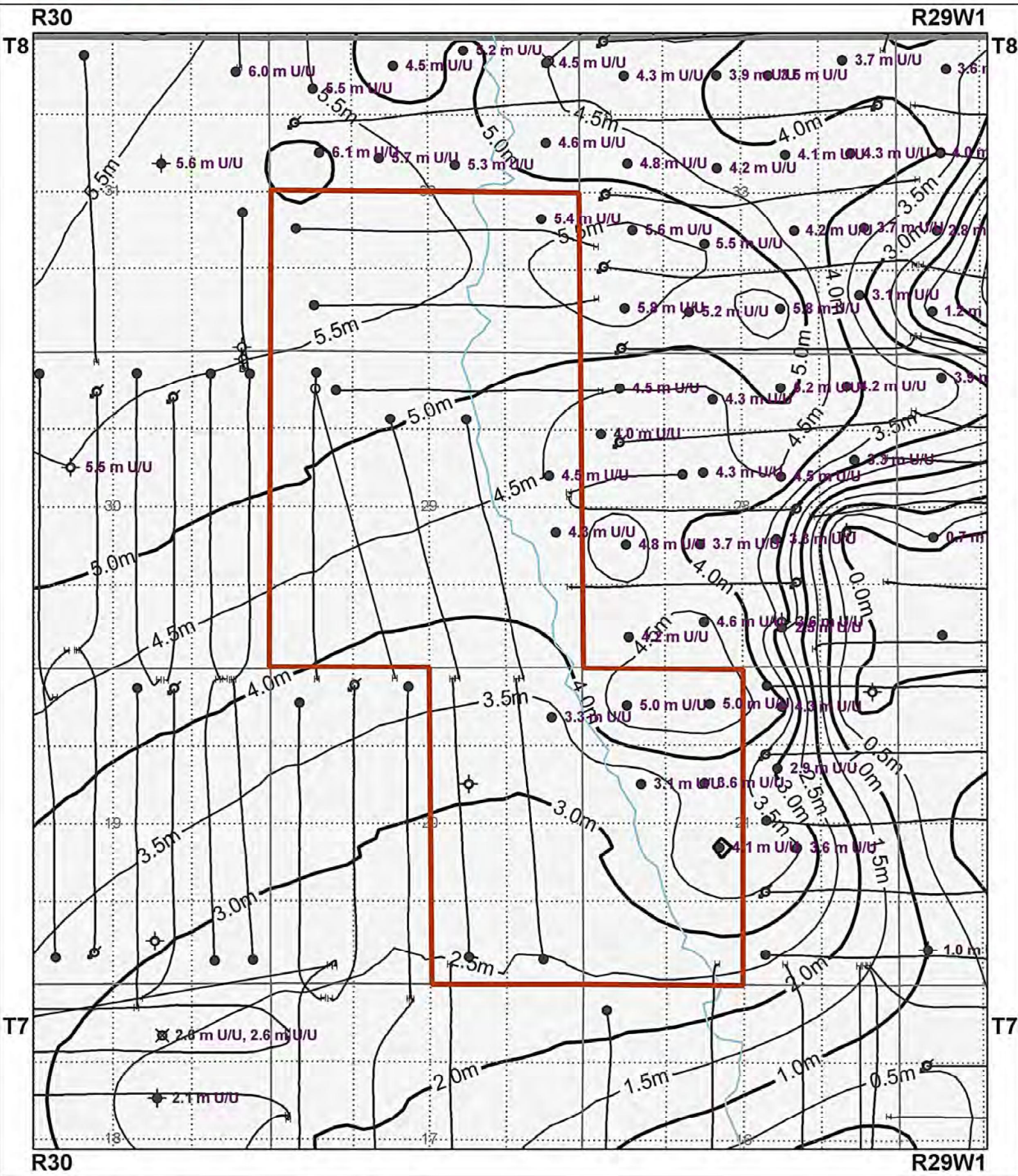

Center: 49.5956, -101.3762

Scale: 1:31,673

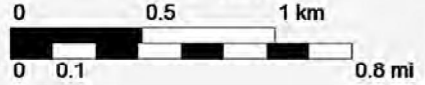

Proposed Sinclair Unit 22  
Upper Lyleton A Isopach  
(m)

# APPENDIX 6

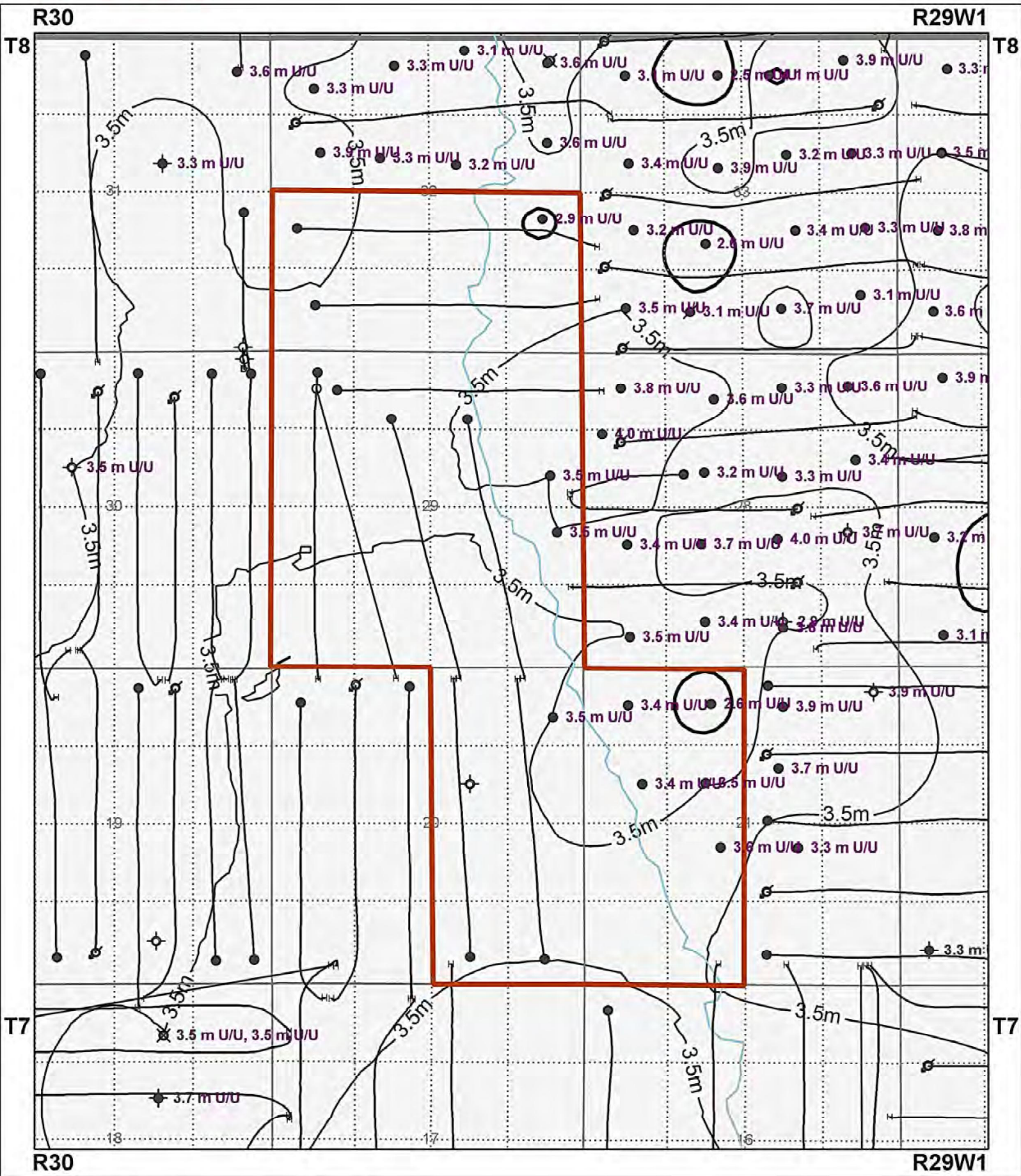

Center: 49.5956, -101.3762

Scale: 1:31,673

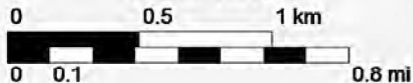

Proposed Sinclair Unit 22  
Lower Lyleton A Isopach  
(m)

# APPENDIX 7



Center: 49.5956, -101.3762

Scale: 1:31,673

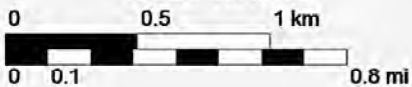

Proposed Sinclair Unit 22  
Core Data Points

## **Proposed Sinclair Unit No. 22**

### **Application for Enhanced Oil Recovery Waterflood Project**

#### **List of Figures**

Figure 1	Daly Sinclair Field Area Map
Figure 2	Sinclair Unit No. 22 Proposed Boundary
Figure 3	Bakken-Three Forks A Pool
Figure 4	Sinclair Unit No. 22 Historical Production
Figure 5	Sinclair Unit No. 22 Development Plan
Figure 6	Sinclair Unit No. 5 Production Profile
Figure 7	Sinclair Unit No. 22 Primary Recovery – Rate v. Time
Figure 8	Sinclair Unit No. 22 Primary Recovery – Rate v. Cumulative Oil
Figure 9	Sinclair Unit No. 22 Primary + Secondary Recovery – Rate v. Time
Figure 10	Sinclair Unit No. 22 Primary + Secondary Recovery – Rate v. Cumulative Oil
Figure 11	Sinclair Unit No. 22 Injection Facilities Process Flow Diagram
Figure 12	Typical Openhole Water Injection Well Downhole Diagram
Figure 13	Planned Corrosion Program

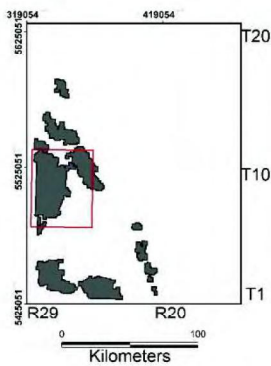
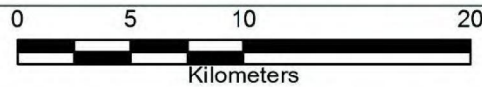
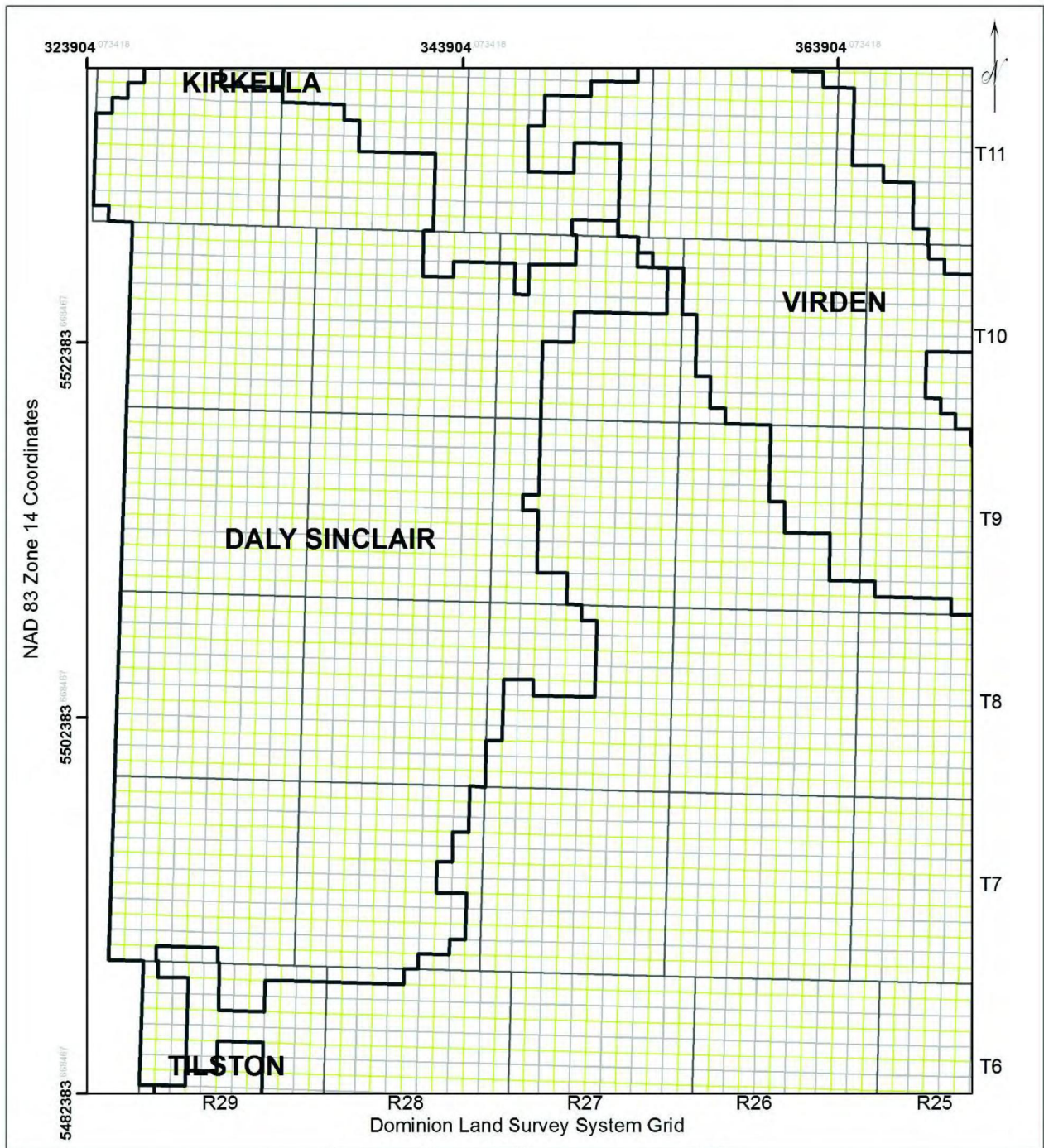

**Map 3**

Manitoba's Designated Fields & Pools 2016  
 Well Information: January 1, 2016.  
 Geology by: P. Fulton-Regula  
 Petroleum Branch

**Legend**

-  2016 Fields
-  Township Grid
-  Section Grid
-  Quarter Section Grid



**Daly Sinclair, Virden & Tilston Fields**

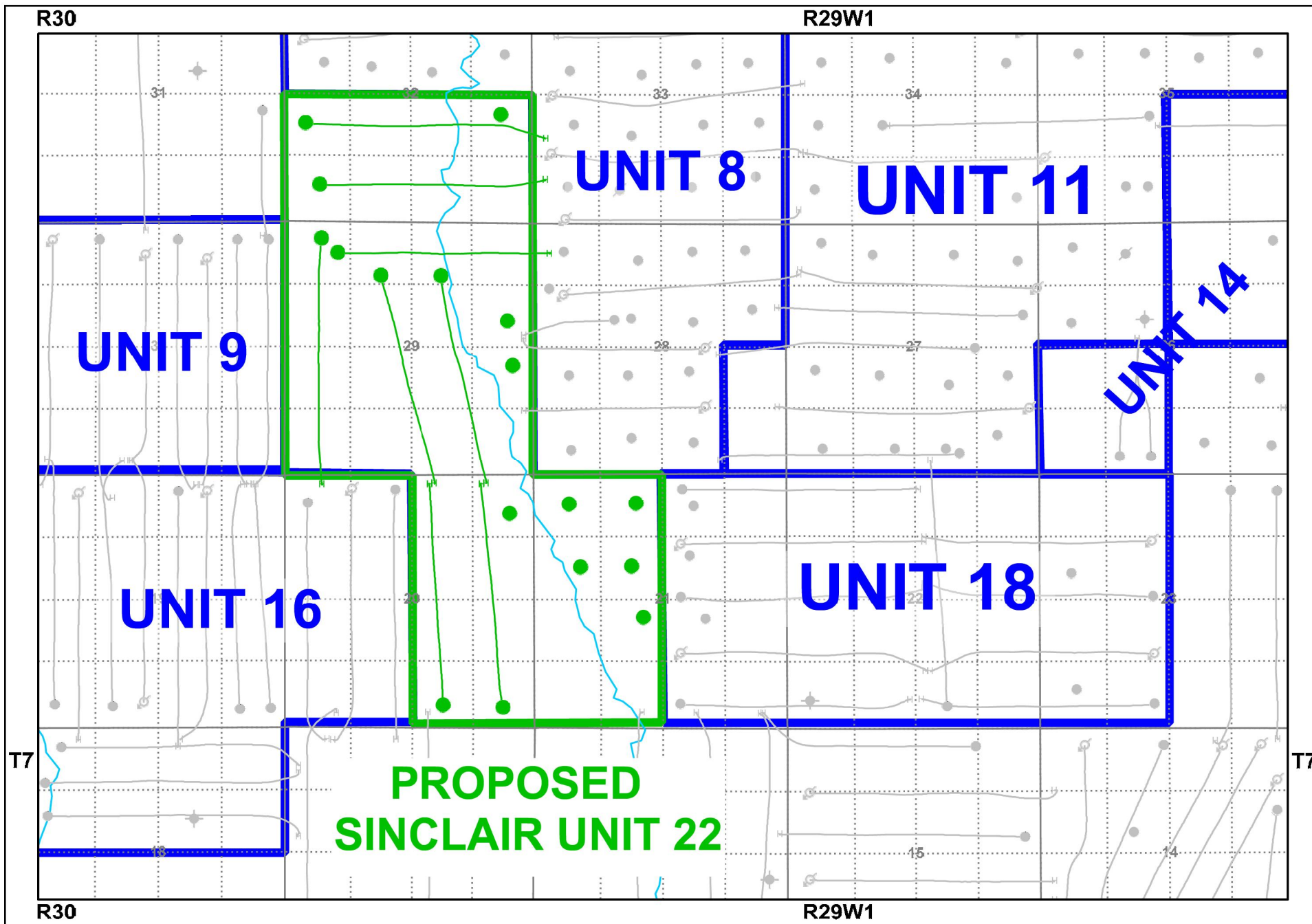

SINCLAIR UNITS



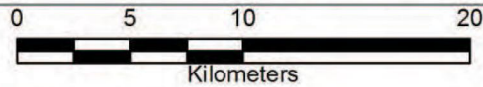
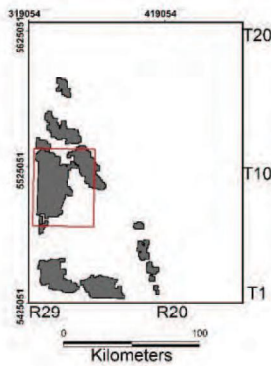
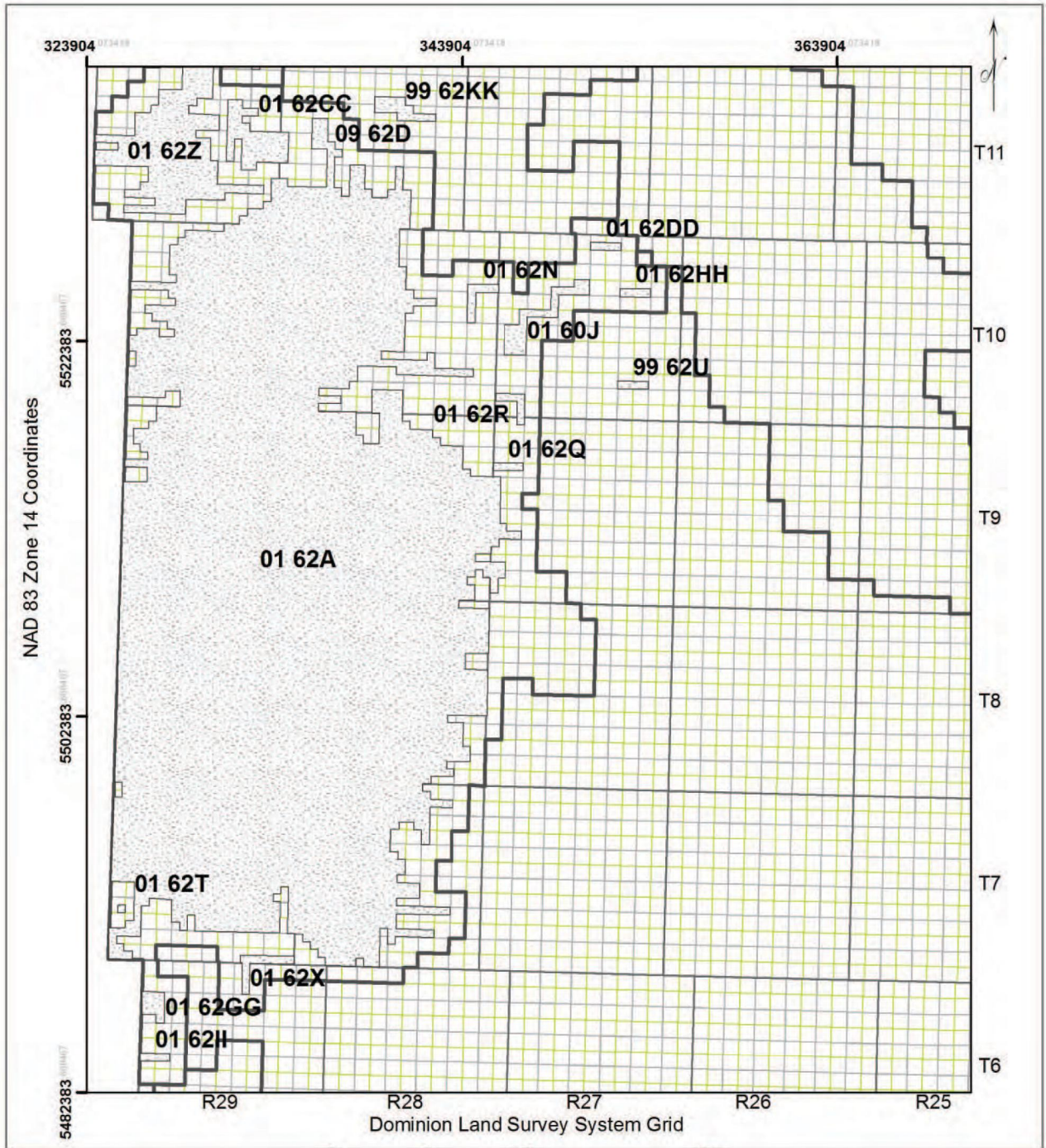

**Map 3**

Manitoba's Designated Fields & Pools 2016  
 Well Information: January 1, 2016.  
 Geology by: P. Fulton-Regula  
 Petroleum Branch

**Legend**

-  2016 Fields
-  Oil Pools
-  Township Grid
-  Section Grid
-  Quarter Section Grid



**Bakken & Bakken Torquay Formation Pools (60 & 62)**

Production Graph

Group:	sinclair unit no. 22 well list.lwell	On Prod:	2007-02 to 2019-04	Cum Oil:	60286.6 m3
# of Wells:	17	Prod Form:	BAKKEN; THREEFK	Cum Gas:	0.0 E3m3
Fluid:	Oil	Field:	DALY (MB1)	Cum Wtr:	196897.2 m3
Mode:	Producing	Pool Code:	MB000162A	Cum Inj Oil:	0.0 m3
		Unit Code:		Cum Inj Gas:	0.0 E3m3
				Cum Inj Wtr:	0.0 m3

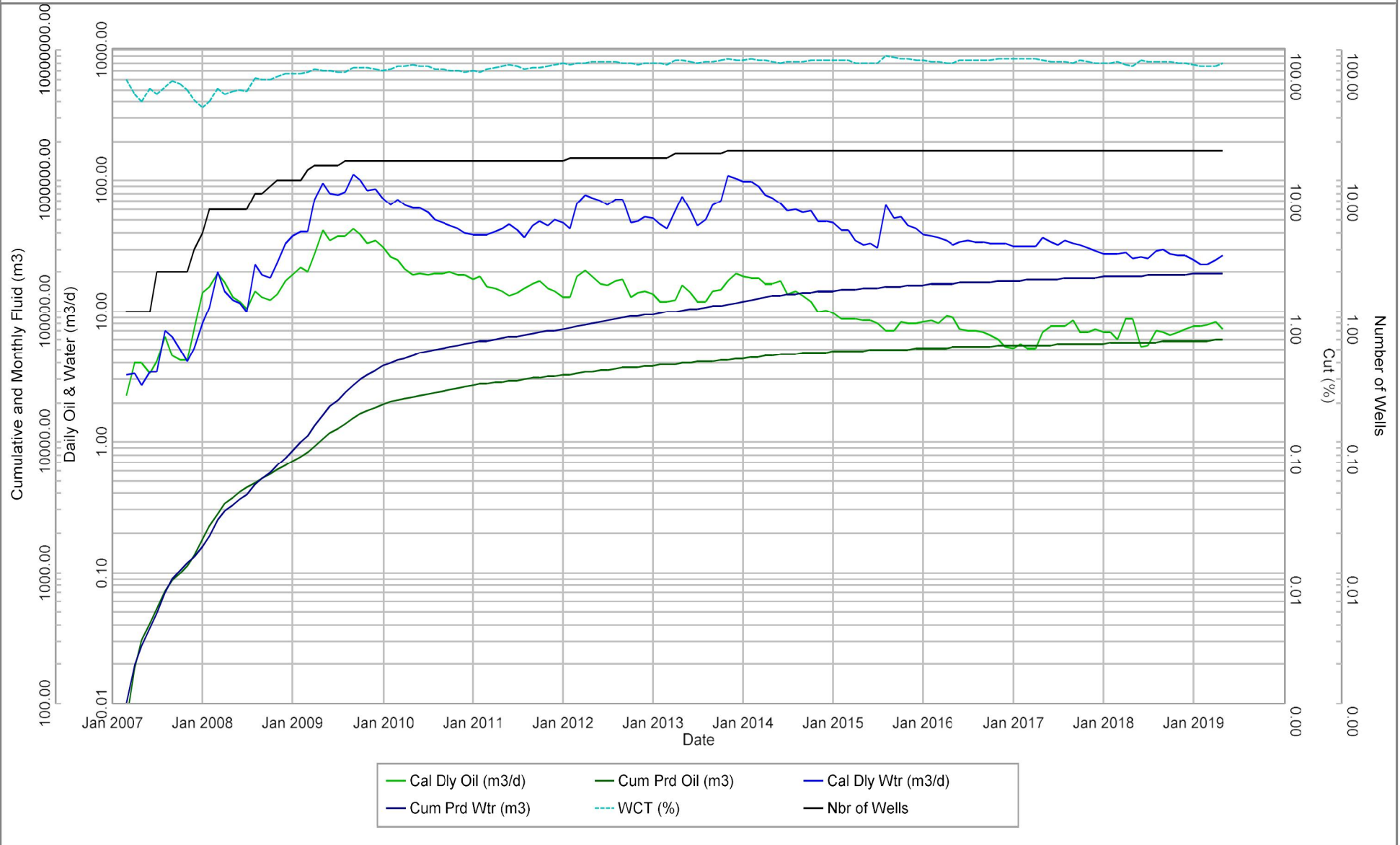
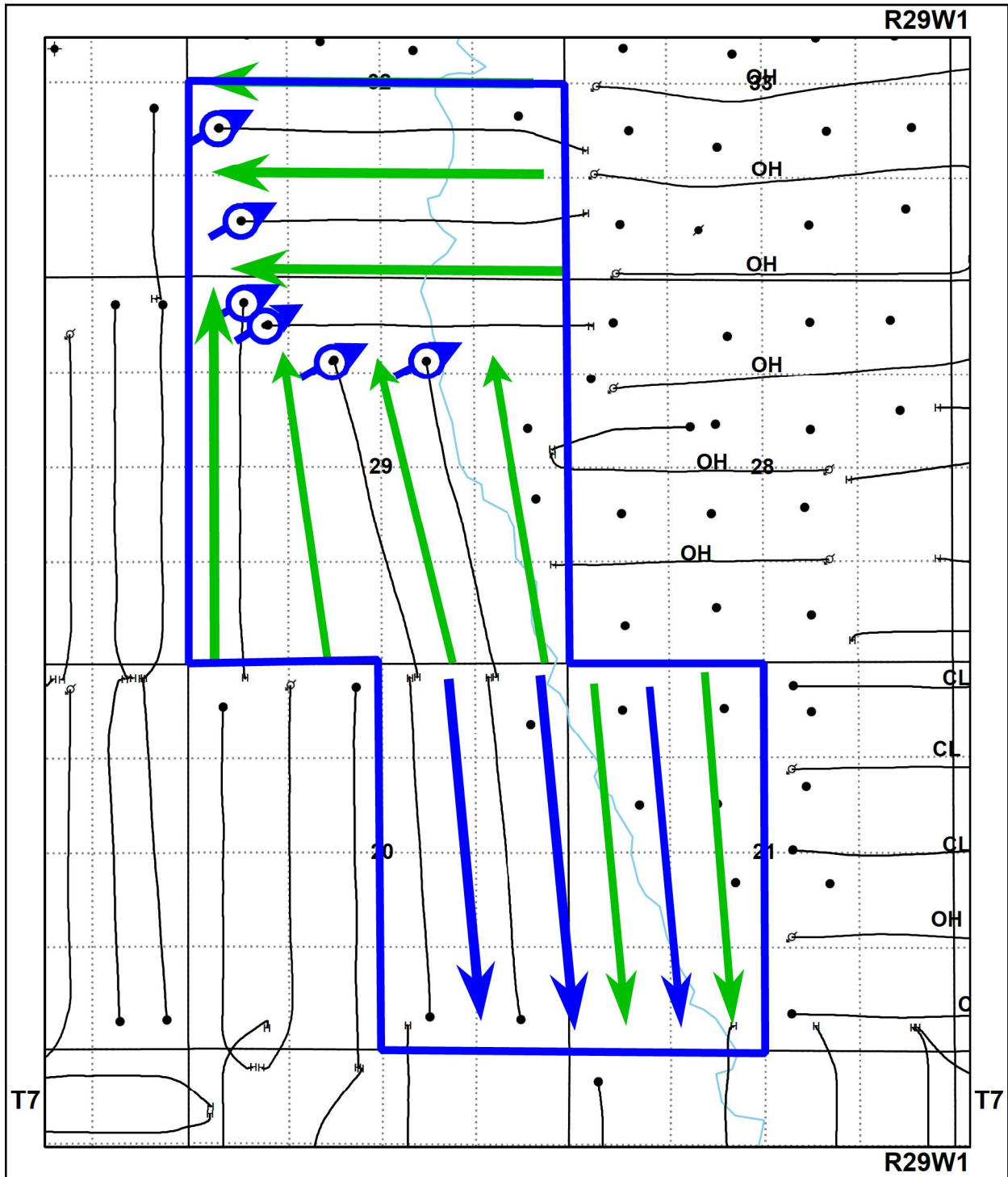

Figure No. 5



Map Title

Datum: NAD27 Projection: Stereographic DLS Version AB: ATS 2.6, BC: PRB 2.0, SK: STS 2.5, MB: MLI07

Well Legend					
⊕ Abandoned Gas	⊕ Drilling	○ Location	⊕ Suspended Heavy Oil	⊕ Wells - CLEANOUTS	⊕ Wells - SU 3 Producers
⊕ Abandoned Heavy Oil	⊕ Dry & Abandoned	● Oil	⊕ Suspended Oil	⊕ Wells - CLEANOUTS 201610 Update	⊕ Wells - Vertical Re-Frac Wells
⊕ Abandoned Oil	⊕ Gas	⊕ Oil & Gas	⊕ Suspended Oil & Gas	⊕ Wells - CO2 Injection	
⊕ Abandoned Oil & Gas	⊕ Gas Injection	⊕ Service or Drain	Lists	⊕ Wells - CO2 Pilot Fence Injection	
⊕ Abandoned Service	⊕ Heavy Oil	⊕ Suspended	⊕ Wells - Bakken Producers	⊕ Wells - CO2 Producers	
⊕ Canceled	⊕ Injection	⊕ Suspended Gas	⊕ Wells - Bakken Wells	⊕ Wells - SU 17 Wells	



© 2019 IHS Markit. All Rights Reserved. Provided "as is", without any warranty. This map is not to be reproduced or disseminated and is not to be used nor cited as evidence in connection with any territorial claim. IHS Markit is impartial and not an authority on international boundaries which might be subject to unresolved claims by multiple jurisdictions.

Production Graph

Group:	sinclair unit no. 5 well list.lwell	On Prod:	2005-03 to 2019-04	Cum Oil:	96240.4 m3
# of Wells:	11	Prod Form:	BAKKENM; BAKKENU; TORQUAY; BAKKEN	Cum Gas:	0.0 E3m3
Fluid:	Oil; Water Injection	Field:	DALY (MB1)	Cum Wtr:	100853.5 m3
Mode:	Producing; Injection; Suspended	Pool Code:	MB000162A	Cum Inj Oil:	0.0 m3
		Unit Code:	162A5	Cum Inj Gas:	0.0 E3m3
				Cum Inj Wtr:	126505.9 m3

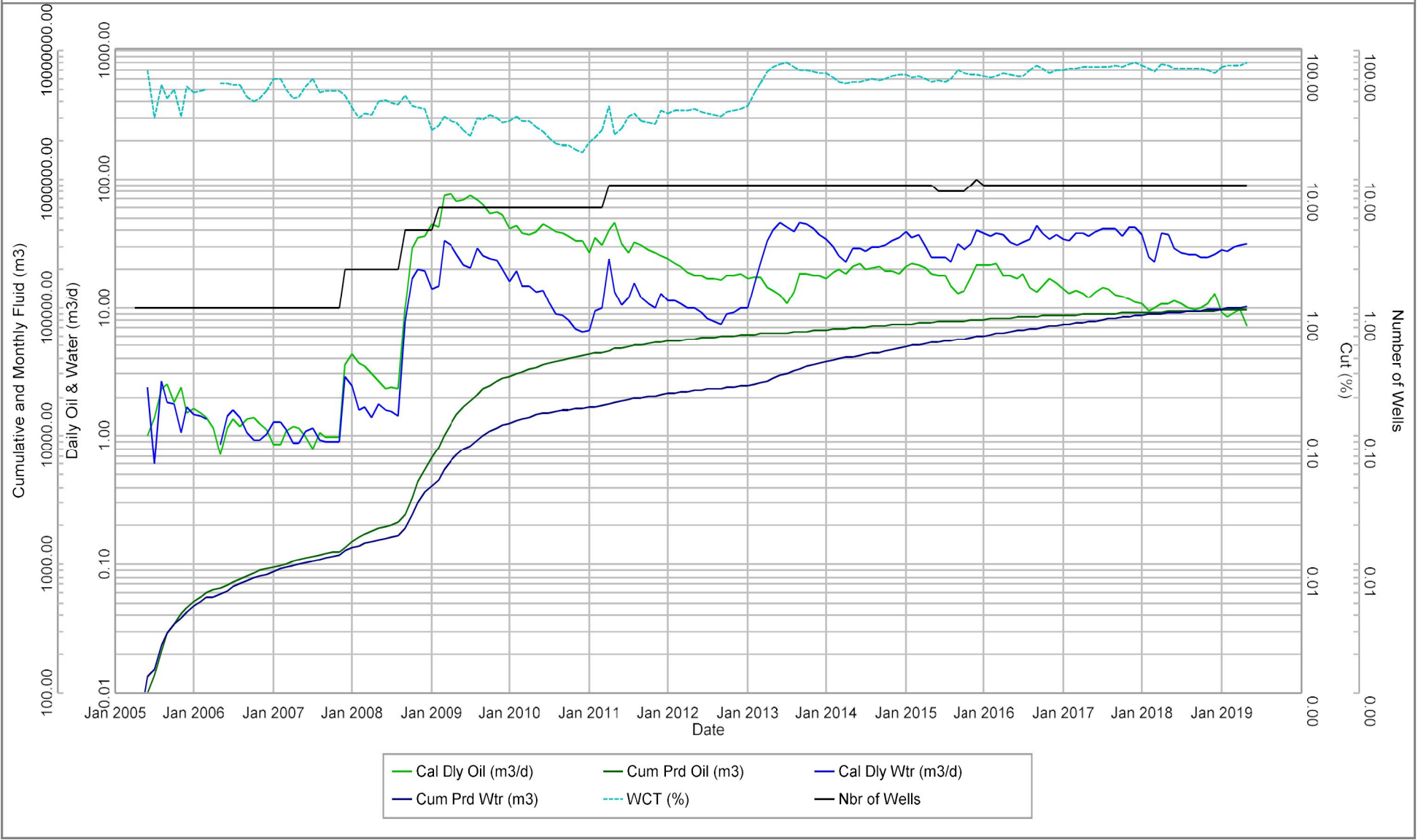

— Cal Dly Oil (m3/d)      — Cum Prd Oil (m3)      — Cal Dly Wtr (m3/d)  
— Cum Prd Wtr (m3)      - - - WCT (%)      — Nbr of Wells

Primary Recovery - Rate vs Time

Figure No. 7

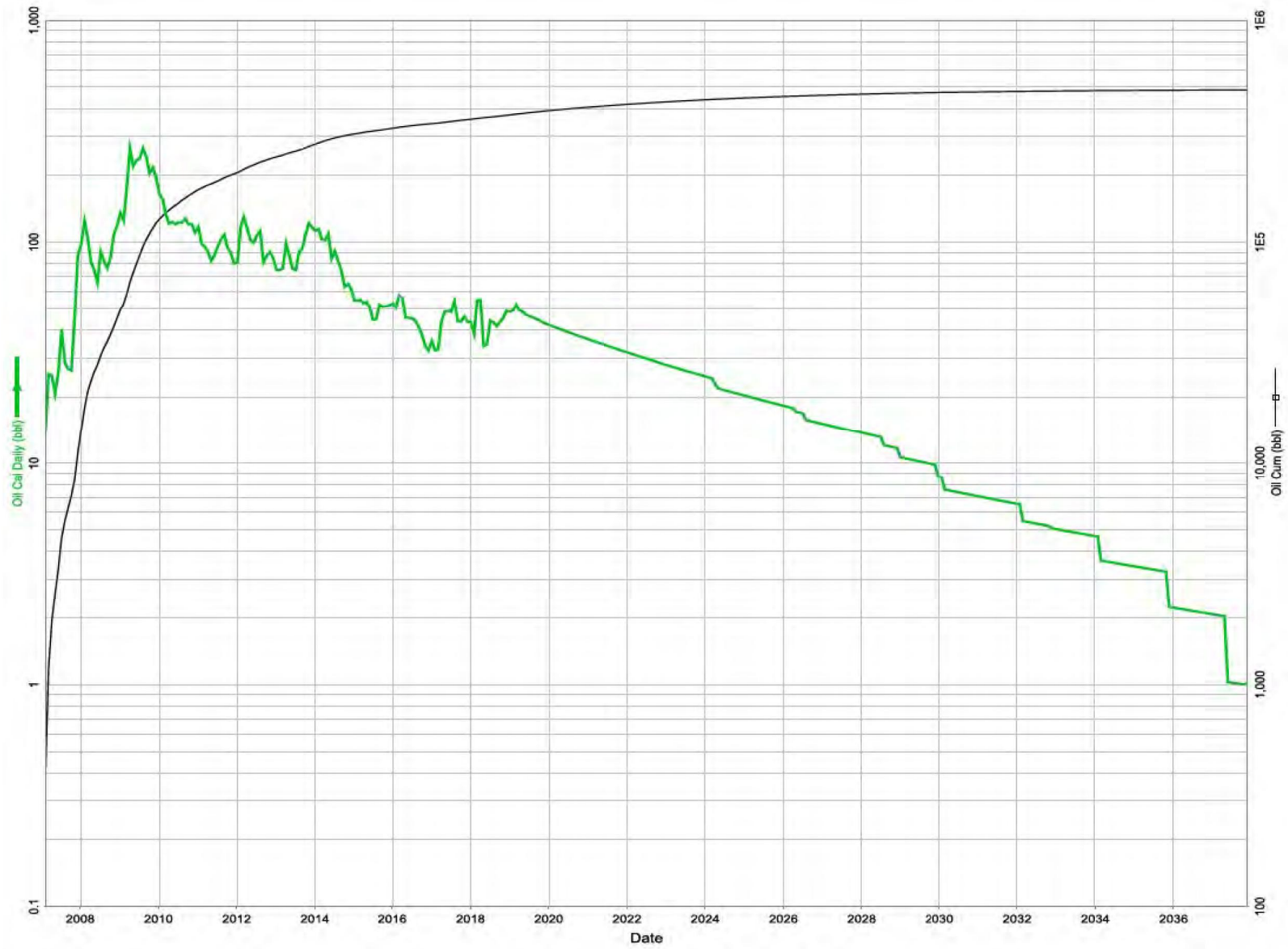

Primary Recovery - Rate vs Cum

Figure No. 8

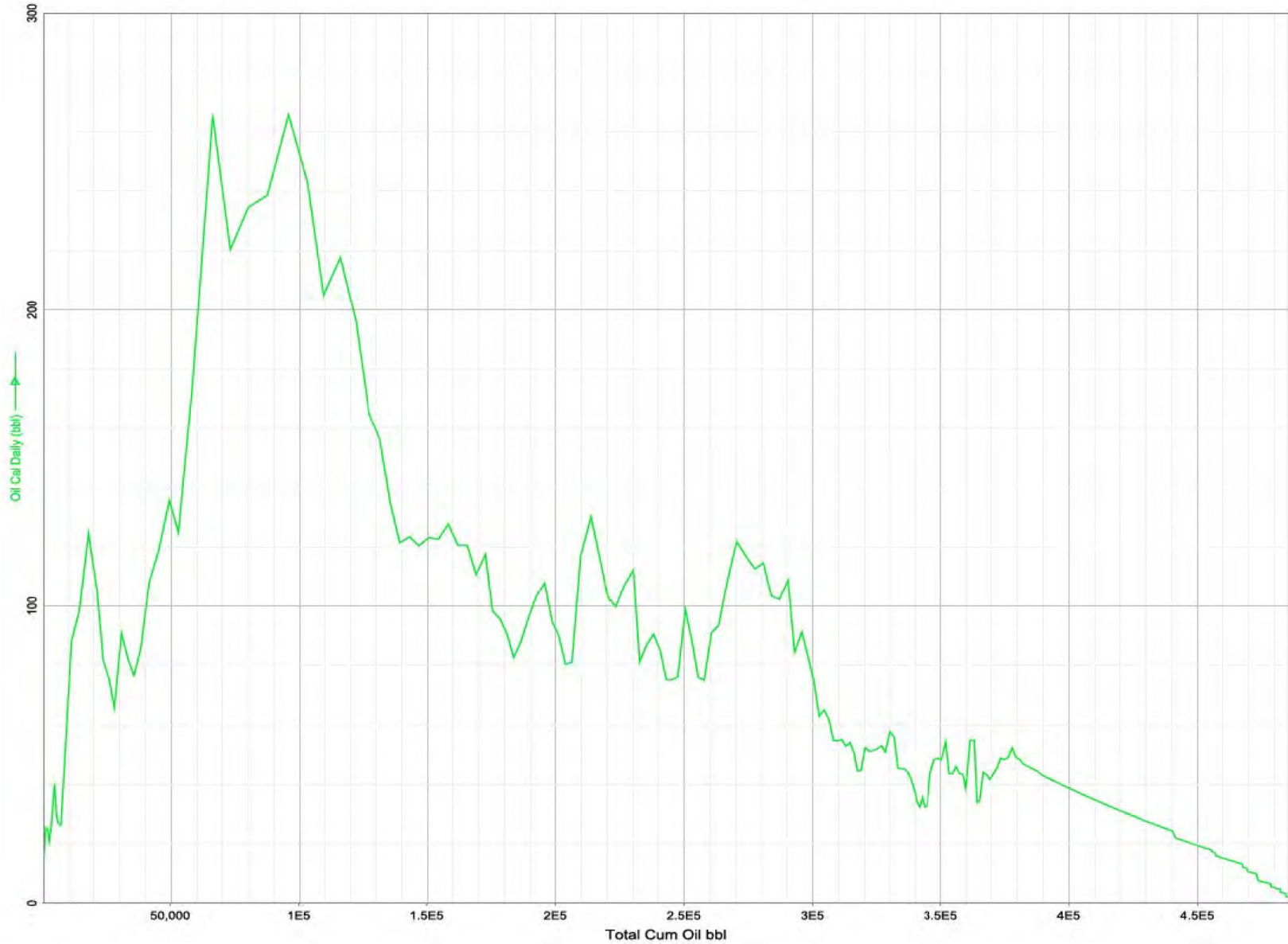

Primary + Secondary Recovery - Rate vs Time

Figure No. 9

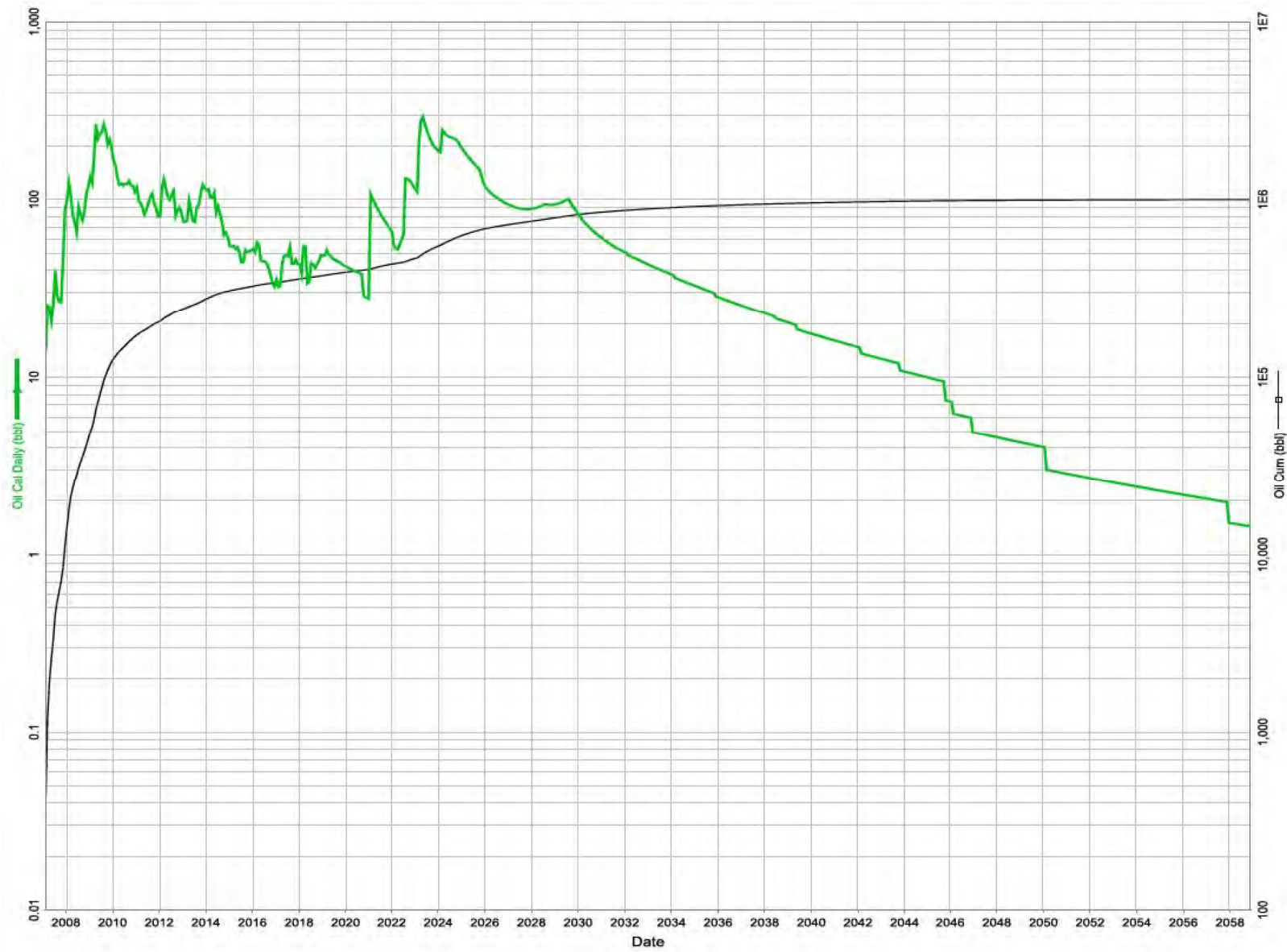

Primary + Secondary Recovery - Rate vs Cum

Figure No. 10

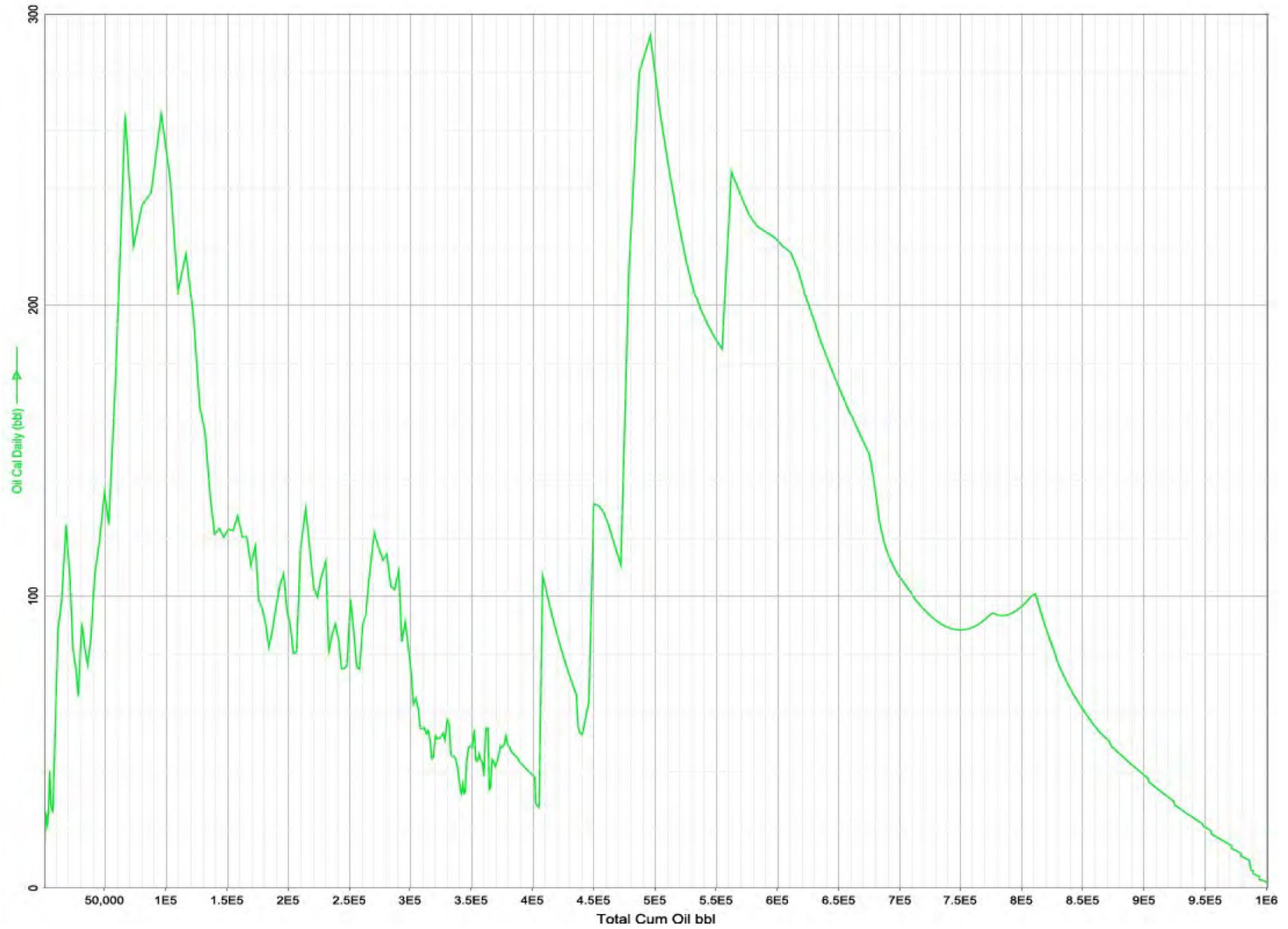
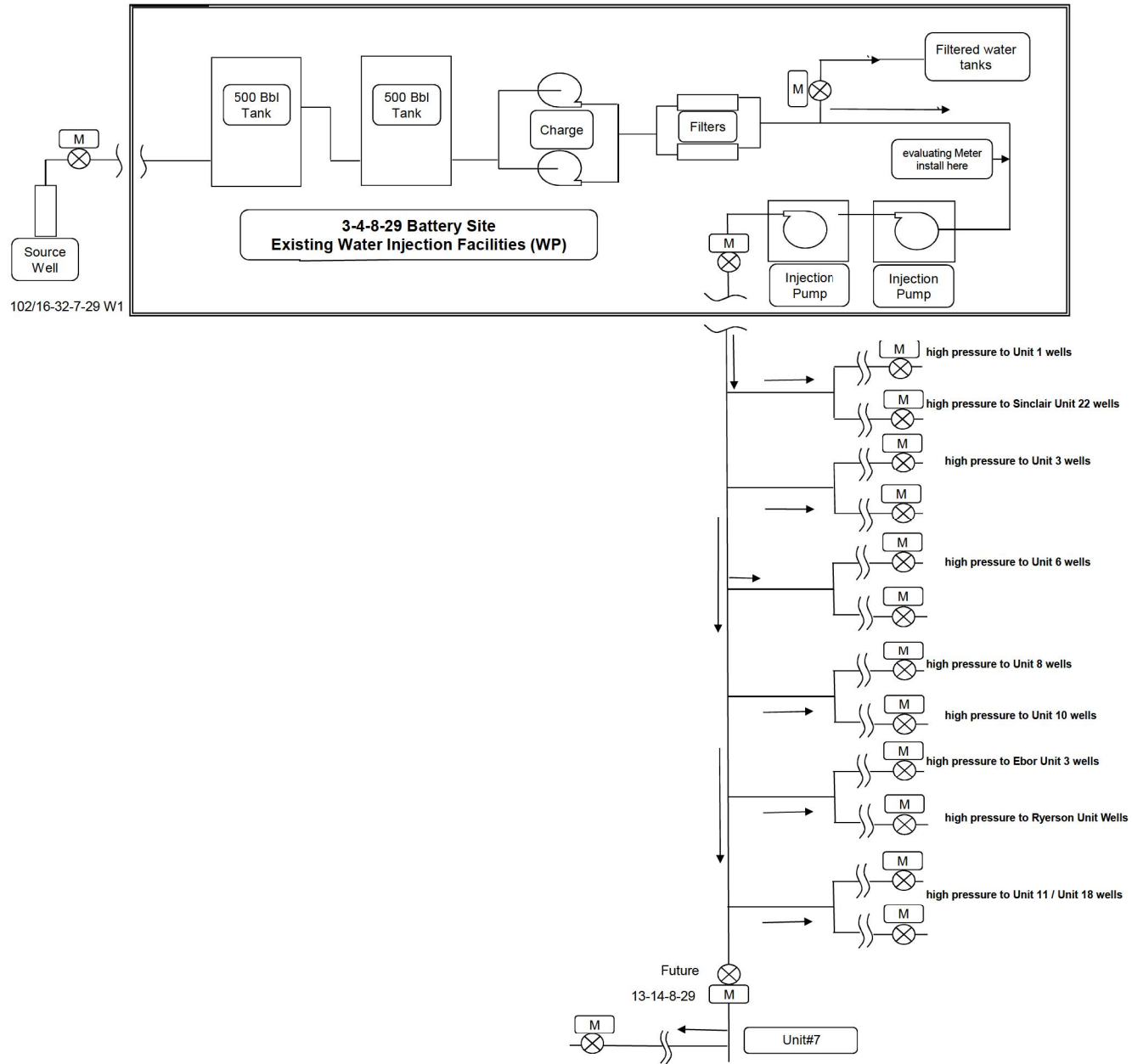



FIGURE 11

### Sinclair Water Injection System





# Sinclair Unit No. 22

## EOR Waterflood Project

### Planned Corrosion Control Program \*\*

#### Source Well

- Continuous downhole corrosion inhibition
- Continuous surface corrosion inhibitor injection
- Downhole scale inhibitor injection
- Corrosion resistant valves and internally coated surface piping

#### Pipelines

- Source well to 3-4-8-29 Water Plant – Fiberglass
- New High Pressure Pipeline to the injection wells – 2000 psi high pressure Fiberglass

#### Facilities

- 3-4-8-29 Water Plant and New Injection Pump Station
  - Plant piping – 600 ANSI schedule 80 pipe, Fiberglass or Internally coated
  - Filtration – Stainless steel bodies and PVC piping
  - Pumping – Ceramic plungers, stainless steel disc valves
  - Tanks – Fiberglass shell, corrosion resistant valves

#### Injection Wellhead / Surface Piping

- Corrosion resistant valves and stainless steel and/or internally coated steel surface piping

#### Injection Well

- Casing cathodic protection where required
- Wetted surfaces coated downhole packer
- Corrosion inhibited water in the annulus between tubing / casing
- Internally coated tubing surface to packer
- Surface freeze protection of annular fluid
- Corrosion resistant master valve
- Corrosion resistant pipeline valve

#### Producing Wells

- Casing cathodic protection where required
- Downhole batch corrosion inhibition as required
- Downhole scale inhibitor injection as required

**Figure 13**

\*\* subject to final design and engineering

**Proposed Sinclair Unit No. 22**

**Application for Enhanced Oil Recovery Waterflood Project**

**List of Tables**

Table 1	Tract Participation
Table 2	Tract Factor Calculation
Table 3	Current Well List and Status
Table 4	Original Oil in Place and Recovery Factors

**TABLE NO. 2: TRACT FACTOR CALCULATIONS FOR SINCLAIR BAKKEN UNIT NO. 22 APPLICATION**  
**TRACT FACTORS BASED ON OIL-IN-PLACE (OOIP) - CUMULATIVE PRODUCTION TO APRIL 2019**

LSD-SEC	Tract	OOIP (m3)	HZ Wells Alloc Cum Prodn (m3)	Vert Wells Cum Prodn (m3)	Sum Hz + Vert Alloc Cum Prodn	OOIP - Cum	Tract Factor (%)	Tract
01-20	01-20-007-29W1M	64,279	1,638.0	0.0	1,638.0	62,641	1.926028140%	01-20-007-29W1M
02-20	02-20-007-29W1M	65,517	1,270.7	0.0	1,270.7	64,246	1.975389072%	02-20-007-29W1M
07-20	07-20-007-29W1M	66,707	1,376.1	0.0	1,376.1	65,331	2.008727295%	07-20-007-29W1M
08-20	08-20-007-29W1M	67,176	1,709.6	0.0	1,709.6	65,466	2.012890085%	08-20-007-29W1M
09-20	09-20-007-29W1M	68,791	1,696.9	0.0	1,696.9	67,094	2.062957723%	09-20-007-29W1M
10-20	10-20-007-29W1M	71,304	1,389.7	0.0	1,389.7	69,914	2.149665005%	10-20-007-29W1M
15-20	15-20-007-29W1M	74,182	911.2	0.0	911.2	73,271	2.252865493%	15-20-007-29W1M
16-20	16-20-007-29W1M	72,783	867.2	973.1	1,840.3	70,943	2.181289661%	16-20-007-29W1M
03-21	03-21-007-29W1M	68,432	0.0	0.0	0.0	68,432	2.104083565%	03-21-007-29W1M
04-21	04-21-007-29W1M	67,260	0.0	0.0	0.0	67,260	2.068056576%	04-21-007-29W1M
05-21	05-21-007-29W1M	69,425	0.0	0.0	0.0	69,425	2.134625446%	05-21-007-29W1M
06-21	06-21-007-29W1M	77,114	0.0	2,602.5	2,602.5	74,511	2.290997674%	06-21-007-29W1M
11-21	11-21-007-29W1M	76,077	0.0	803.0	803.0	75,274	2.314461571%	11-21-007-29W1M
12-21	12-21-007-29W1M	68,828	0.0	1,123.2	1,123.2	67,705	2.081729870%	12-21-007-29W1M
13-21	13-21-007-29W1M	83,952	0.0	1,356.5	1,356.5	82,595	2.539571366%	13-21-007-29W1M
14-21	14-21-007-29W1M	86,251	0.0	3,991.8	3,991.8	82,259	2.529228595%	14-21-007-29W1M
01-29	01-29-007-29W1M	80,344	1,019.8	0.0	1,019.8	79,324	2.438987597%	01-29-007-29W1M
02-29	02-29-007-29W1M	79,609	1,865.4	0.0	1,865.4	77,743	2.390385393%	02-29-007-29W1M
03-29	03-29-007-29W1M	81,918	228.1	0.0	228.1	81,689	2.511713300%	03-29-007-29W1M
04-29	04-29-007-29W1M	85,099	961.6	0.0	961.6	84,138	2.586994490%	04-29-007-29W1M
05-29	05-29-007-29W1M	88,919	1,078.8	0.0	1,078.8	87,840	2.700837471%	05-29-007-29W1M
06-29	06-29-007-29W1M	85,734	1,031.0	0.0	1,031.0	84,703	2.604365985%	06-29-007-29W1M
07-29	07-29-007-29W1M	83,870	1,967.2	0.0	1,967.2	81,903	2.518269937%	07-29-007-29W1M
08-29	08-29-007-29W1M	83,734	349.3	3,449.6	3,798.9	79,935	2.457785081%	08-29-007-29W1M
09-29	09-29-007-29W1M	85,131	0.0	5,708.8	5,708.8	79,422	2.442007884%	09-29-007-29W1M
10-29	10-29-007-29W1M	88,141	1,787.9	0.0	1,787.9	86,353	2.655115811%	10-29-007-29W1M
11-29	11-29-007-29W1M	90,429	1,541.7	0.0	1,541.7	88,887	2.733017431%	11-29-007-29W1M
12-29	12-29-007-29W1M	93,608	1,081.4	0.0	1,081.4	92,526	2.844915081%	12-29-007-29W1M
13-29	13-29-007-29W1M	97,415	1,933.3	0.0	1,933.3	95,482	2.935783654%	13-29-007-29W1M
14-29	14-29-007-29W1M	94,663	2,580.6	0.0	2,580.6	92,082	2.831266856%	14-29-007-29W1M
15-29	15-29-007-29W1M	91,093	2,633.7	0.0	2,633.7	88,459	2.719862242%	15-29-007-29W1M
16-29	16-29-007-29W1M	88,080	2,058.5	0.0	2,058.5	86,021	2.644903332%	16-29-007-29W1M
01-32	01-32-007-29W1M	92,980	637.1	0.0	637.1	92,343	2.839275435%	01-32-007-29W1M
02-32	02-32-007-29W1M	93,904	681.8	0.0	681.8	93,222	2.866297281%	02-32-007-29W1M
03-32	03-32-007-29W1M	95,751	677.3	0.0	677.3	95,074	2.923235282%	03-32-007-29W1M
04-32	04-32-007-29W1M	98,271	477.5	0.0	477.5	97,793	3.006858443%	04-32-007-29W1M
05-32	05-32-007-29W1M	101,662	1,044.4	0.0	1,044.4	100,617	3.093696653%	05-32-007-29W1M
06-32	06-32-007-29W1M	97,317	1,112.6	0.0	1,112.6	96,204	2.958008269%	06-32-007-29W1M
07-32	07-32-007-29W1M	94,716	1,129.6	0.0	1,129.6	93,586	2.877512768%	07-32-007-29W1M
08-32	08-32-007-29W1M	92,161	1,018.0	522.1	1,540.1	90,621	2.786337187%	08-32-007-29W1M
		<b>3,312,625</b>	<b>39,756.0</b>	<b>20,530.6</b>	<b>60,286.6</b>	<b>3,252,339</b>	<b>100.00000000%</b>	

TABLE NO. 3 - Well List and Status

UWI	License Number	Type	Pool Name	Producing Zone	Mode	On Production Date	Prod Date	Cal Dly Oil (m3/d)	Monthly Oil (m3)	Cum Prd Oil (m3)	Cal Dly Water (m3/d)	Monthly Water (m3)	Cum Prd Water (m3)	WCT (%)
100/01-20-007-29W1/0	006892	Horizontal	BAKKEN-THREE FORKS A	BAKKEN	Producing	2/28/2009	Apr-2019	0.54	16.20	6003.70	2.34	70.30	22840.80	81.27
100/02-20-007-29W1/0	006918	Horizontal	BAKKEN-THREE FORKS A	BAKKEN	Producing	7/29/2009	Apr-2019	0.45	13.60	4855.70	1.48	44.40	19454.40	76.55
100/16-20-007-29W1/0	006593	Vertical	BAKKEN-THREE FORKS A	BAKKEN	Producing	7/9/2008	Apr-2019	0.18	5.30	973.10	0.43	13.00	3098.90	71.04
100/06-21-007-29W1/0	006287	Vertical	BAKKEN-THREE FORKS A	BAKKEN	Producing	6/30/2007	Apr-2019	0.21	6.20	2602.50	0.40	12.10	3441.80	66.12
100/11-21-007-29W1/0	006546	Vertical	BAKKEN-THREE FORKS A	BAKKEN	Producing	1/31/2008	Apr-2019	0.06	1.70	803.00	0.39	11.80	2535.00	87.41
100/12-21-007-29W1/0	006728	Vertical	BAKKEN-THREE FORKS A	BAKKEN	Producing	9/22/2008	Apr-2019	0.07	2.20	1123.20	0.91	27.20	3206.60	92.52
100/13-21-007-29W1/0	006537	Vertical	BAKKEN-THREE FORKS A	BAKKEN	Producing	1/31/2008	Apr-2019	0.26	7.70	1356.50	0.30	8.90	2871.10	53.61
100/14-21-007-29W1/0	006225	Vertical	BAKKEN-THREE FORKS A	BAKKEN	Producing	2/18/2007	Apr-2019	0.42	12.60	3991.80	0.28	8.40	4247.00	40.00
100/08-29-007-29W1/0	006504	Vertical	BAKKEN-THREE FORKS A	BAKKEN	Producing	12/20/2007	Apr-2019	0.32	9.50	3449.60	0.30	9.00	2497.20	48.65
100/09-29-007-29W1/0	006465	Vertical	BAKKEN-THREE FORKS A	BAKKEN	Producing	11/20/2007	Apr-2019	0.48	14.30	5708.80	0.31	9.30	1940.20	39.41
100/13-29-007-29W1/0	006750	Horizontal	BAKKEN-THREE FORKS A	BAKKEN	Producing	10/31/2008	Apr-2019	0.69	20.60	7169.30	2.41	72.30	20844.60	77.83
102/13-29-007-29W1/0	009204	Horizontal	BAKKEN-THREE FORKS A	BAKKEN,THREEFK	Producing	3/17/2013	Apr-2019	1.62	48.50	4130.80	5.37	161.00	23101.60	76.85
100/14-29-007-29W1/0	006905	Horizontal	BAKKEN-THREE FORKS A	BAKKEN	Producing	3/18/2009	Apr-2019	0.36	10.90	5072.90	1.35	40.50	22462.70	78.79
100/15-29-007-29W1/0	006893	Horizontal	BAKKEN-THREE FORKS A	BAKKEN	Producing	2/28/2009	Apr-2019	0.46	13.70	5745.30	1.04	31.30	17503.70	69.56
100/04-32-007-29W1/0	008783	Horizontal	BAKKFN-THREE FORKS A	THREFFK,BAKKFN	Producing	10/3/2013	Apr-2019	0.55	16.60	2473.70	5.05	151.40	19686.20	90.12
100/05-32-007-29W1/0	008363	Horizontal	BAKKEN-THREE FORKS A	BAKKEN	Producing	1/31/2012	Apr-2019	0.61	18.40	4304.60	3.91	117.30	22859.50	86.44
100/08-32-007-29W1/0	006657	Vertical	BAKKEN-THREE FORKS A	BAKKEN	Producing	7/7/2008	Apr-2019	0.06	1.70	522.10	0.55	16.50	4305.90	90.66
										<b>60286.60</b>			<b>196897.20</b>	

**TABLE NO. 4: OOIP Calculation**

LSD	Area (m <sup>2</sup> )	Mid Bkn Iso (m)	Upr A Iso (m)	Lwr A Iso (m)	Mid Bkn OOIP (m <sup>3</sup> )	Upr A OOIP (m <sup>3</sup> )	Lwr A OOIP (m <sup>3</sup> )	Sum OOIP (m <sup>3</sup> )	Sum OOIP (bbl)
01-20-007-29	158596	2.4	2.6	3.5	10265	33248	20766	64279	404303
02-20-007-29	158487	2.7	2.6	3.5	11540	33226	20752	65517	412090
07-20-007-29	158287	2.4	2.8	3.5	10245	35736	20726	66707	419573
08-20-007-29	158397	2.2	2.9	3.5	9397	37038	20740	67176	422522
09-20-007-29	158203	2.0	3.1	3.5	8533	39544	20715	68791	432684
10-20-007-29	158108	2.3	3.2	3.5	9807	40795	20702	71304	448489
15-20-007-29	157908	2.1	3.5	3.5	8943	44563	20676	74182	466591
16-20-007-29	158003	1.9	3.5	3.4	8096	44590	20097	72783	457793
03-21-007-29	161359	2.2	2.9	3.5	9573	37731	21128	68432	430424
04-21-007-29	160629	2.3	2.8	3.5	9963	36265	21032	67260	423054
05-21-007-29	160657	1.9	3.1	3.5	8232	40158	21036	69425	436672
06-21-007-29	161388	1.8	3.7	3.5	7834	48148	21132	77114	485029
11-21-007-29	161393	1.7	3.7	3.4	7399	48150	20529	76077	478511
12-21-007-29	160676	1.6	3.2	3.4	6933	41458	20437	68828	432916
13-21-007-29	160704	1.2	4.5	3.4	5201	58310	20441	83952	528042
14-21-007-29	161421	1.3	4.8	3.0	5659	62475	18117	86251	542502
01-29-007-29	160910	1.7	4.0	3.5	7377	51898	21069	80344	505348
02-29-007-29	161170	1.8	3.9	3.5	7823	50682	21103	79609	500724
03-29-007-29	161446	2.0	4.0	3.5	8708	52071	21139	81918	515246
04-29-007-29	161718	2.1	4.2	3.5	9158	54766	21175	85099	535259
05-29-007-29	161558	1.8	4.6	3.5	7842	59923	21154	88919	559285
06-29-007-29	161287	1.7	4.4	3.5	7394	57221	21118	85734	539249
07-29-007-29	161040	1.6	4.3	3.5	6949	55835	21086	83870	527525
08-29-007-29	160780	1.6	4.3	3.5	6937	55745	21052	83734	526674
09-29-007-29	160661	1.2	4.5	3.6	5199	58295	21637	85131	535459
10-29-007-29	160941	1.4	4.7	3.5	6076	60992	21073	88141	554392
11-29-007-29	161158	1.6	4.8	3.5	6954	62373	21102	90429	568780
12-29-007-29	161409	1.7	5.0	3.5	7400	65073	21134	93608	588774
13-29-007-29	161248	1.7	5.3	3.5	7392	68909	21113	97415	612721
14-29-007-29	160998	1.4	5.2	3.5	6078	67504	21081	94663	595412
15-29-007-29	160812	1.2	5.0	3.5	5204	64833	21056	91093	572957
16-29-007-29	160531	1.0	4.8	3.6	4329	62131	21620	88080	554005
01-32-007-29	159163	0.8	5.4	3.4	3434	69301	20245	92980	584826
02-32-007-29	158828	1.2	5.4	3.3	5140	69156	19608	93904	590635
03-32-007-29	157375	1.4	5.5	3.4	5942	69792	20017	95751	602254
04-32-007-29	157077	1.6	5.6	3.5	6778	70926	20567	98271	618104
05-32-007-29	156197	1.5	5.9	3.6	6318	74307	21036	101662	639434
06-32-007-29	156495	1.3	5.7	3.4	5486	71925	19906	97317	612106
07-32-007-29	159763	1.1	5.5	3.2	4739	70851	19126	94716	595746
08-32-007-29	160098	0.9	5.4	3.1	3886	69709	18567	92161	579677

**3312625 20835785**

Boi	1.1
Porosity	0.161
Mid Bkn N/G	0.335
Upr A N/G	0.787
Lwr A N/G	0.426
Mid Bkn Sw	0.45
Upr A Sw	0.30
Lwr A Sw	0.40